

**Catalog 2019**  
*Katalógus 2019*





**Felo** Werkzeugfabrik  
Holland-Letz GmbH  
Emil-Rössler-Straße 59  
D - 35279 Neustadt (Hessen)

Tel.: ++49 (0) 66 92 - 88 0  
Fax: ++49 (0) 66 92 - 88 99  
Email: [info@felo.com](mailto:info@felo.com)  
[www.felo.com](http://www.felo.com)

---



**1878** Povestea Felo își are începuturile în 1878, când „Hammermühle”, o fabrică ce producea scule de mână forjate, precum ciocane, clești și șurubelnițe a fost înființată. În 1950 compania a fost relocalată la Neustadt (Hessen) și a reînceput producția sub numele Felo. Motivată de puterea sa inovativă, conștiința calității și entuziasm, compania a devenit unul din principalii producători de șurubelnițe din lume.

**1878** Történetünk 1878-ra nyúlik vissza, amikor kovácsolt szerszámok gyártására megalakult vállalatunk elődje „Hammermühle” néven. 1950-ben a cég Neustadtba költözött és FELO néven újraindították a termelést. Az innováció, a minőség iránti elkötelezettség és a lelkesedés a világ egyik vezető csavarhúzógyártójává tette vállalatunkat.



**40** Felo este o marcă tradițional puternică în export. Acum aproape 100 de ani am fost printre primii ce au folosit cataloage în mai multe limbi. Încă de la începuturi ne-am adaptat gama de produse în funcție de cerințele specifice fiecărei piețe. Acum Felo este un jucător global și specialist, exportând în mai mult de 40 de țări din lume.

**40** FELO régi hagyományokkal rendelkezik az export terén. Majd 100 éve kezdtük el használni a többnyelvű katalógusokat. Választékunkat már nagyon korán a különböző piaci igényekhez igazítottuk. A FELO jelenleg több mint 40 országba exportál, köztük Magyarországra is.

**260** Misiunea noastră de a avea sculele cele mai bune a fost dintotdeauna forța ce a propulsat Felo și care a făcut ca inovațiile să fie întotdeauna prezente în gama noastră de produse. Produse unice la timpul lor precum șurubelnițele cu mâner bi-component, biții Titanizați și primele sisteme de lame interschimbabile pentru electricieni au izvorât din ideile Felo. **260** de aplicații pentru drepturi de proprietate industrială documentează puterea noastră inovatoare!



























**260** *A FELO mindig elkötelezett volt a fejlesztés terén. Folyamatosan törekszünk a jobb, hasznosabb szerszámok kifejlesztésére. Olyan fejlesztések fűződnek a nevünkhöz, mint az első kétkomponenses markolat, a TiN bevonatú bitek és a cserélhető pengés csavarhúzó szigetelt kivitelben, villanszerelők számára. 260 szabadalmi jog bizonyítja innovációs erőnket.*

**2000** Mai mult de 2000 de produse diferite se regăsesc în stocul nostru și sunt puse la dispoziția clienților noștri. În plus, producem cam același număr de produse în versiuni personalizate, drept scule speciale și sub marcă privată. **Clienții noștri vor găsi întotdeauna soluțiile potrivite nevoilor lor aici la Felo.**

**2000** *Raktárunkban több mint 2000 termékünk várja a vevői igényeket. Ezenkívül ugyanennyi féle szerszámot gyártunk egyedi kivitelben és más márkanév alatt. Partnereink legtöbbször megtalálják a megoldást a FELO szerszámaival.*

**1** Misiunea ce ne ține împreună-vrem să ne inspirăm clienții. **Felo este un lider în ceea ce privește inovația și calitatea și vrem să rămânem la conducere prin punerea la dispoziția clienților noștri a sculelor de cea mai bună calitate și cu cele mai avansate caracteristici. Aceasta va rămâne provocarea și misiunea noastră.**

**1** *Küldetésünk összekovácsol a bennünket inspiráló partnereinkkel. Vezető szerepet töltünk be az innováció és a minőségi szerszám gyártása terén, és ezt a pozíciót nem szeretnénk elveszíteni, ezért törekszünk a legkiválóbb szerszámok kifejlesztésére. Ez a kihívás biztosítja jövőnket!*

										
	Series 400 Pg/S. 4 - 17	Series 550 Pg/S. 18 - 21	Series 500 Pg/S. 22 - 33	Series 206 Pg/S. 34 - 35	Series 200 Pg/S. 36 - 41	Series 330/ Series 490 Pg/S. 42 - 45	VDE/ Insulated Pg/S. 46 - 81	Series Nm Pg/S. 82 - 87	Series 240/ 250 ESD & 280 Pg/S. 88 - 93	
<b>for slotted screws</b> <i>Schlitzschrauben</i>		6-8, 12-15	19-21	23-24, 26-27, 29-33	35	37 - 41	43-44	48-51, 53-56, 59-61, 63-65, 68-71, 79-80	83-84, 86-87	89, 91-93
<b>PZ Pozidriv-Superdriv</b>		6-8, 12-15	19	23-24, 26, 29, 31-33	35	37, 39-41	43-44	48-51, 53, 56, 59-61, 63-64, 68-71, 79	83-84, 86-87	89, 92
<b>PH Phillips</b>		6-7, 9, 12-15	19-20	23-24, 26-27, 29-33	35	37-41	43-44	48-51, 53, 55-56, 59-61, 63-65, 68-71, 79-80	83-84, 86-87	89, 91-93
<b>+ / - Plus - Minus</b>								48, 54, 70-71	86-87	
<b>Torx® Torx®</b>		9, 12, 15-16		25-26, 29-31		38-39		49, 51, 54, 56, 60, 68, 70-71	83-84, 86	90-92
<b>Torx® TR Torx® Tamper Resistant</b>		9		24, 32						
<b>Torx Plus® IP</b>				25					83-84, 86	
<b>Inner Hexagon Innensechskant</b>				28					86	90
<b>Nut Drivers Steckschlüssel</b>		10, 15		28			44	57		90, 92
<b>SQ Square for Robertson® screws</b>		9, 15						49, 54, 71		
<b>XZN XZN</b>										
<b>Clutch</b>										
<b>Spanner</b>								69		
<b>TS for TorqSet® screws</b>										
<b>Tri-Wing®</b>										90-91
<b>LocTec®</b>										
<b>Pentalobe</b>										90-91
<b>Bitholder/ Bithalter 1/4"</b>		11		28				57, 59-60	83-84, 86	90-91

TORX® und TORX PLUS® sind eingetragene Marken von Acument Intellectual Properties, LLC.

Series 370 Pg/S. 94 - 95	T-Handles/ Series 340 Pg/S. 96 - 99	Hex & Torx L-Keys & Flagdrivers Pg/S. 100 - 107	R-GO XS Pg/S. 108 - 121	smart Pg/S. 122 - 129	Impact Torsion Challenger TiN Industrial Pg/S. 130 - 157	Bit-Sets Pg/S. 158 - 177	Special-Bits Adapters Bitholders Pg/S. 178 - 187	Pliers Pg/S. 188 - 195	Displays Pg/S. 196 - 215	
95	99		110, 113-114, 117-119	124-127, 129	136, 138, 142, 147, 149-150, 155-156	159-161, 172-177	181		197-211	⊖
95	99		110, 113-114, 117-119	124, 127, 129	132-133, 135-138, 140-143, 147, 149-156	159-177	180-181, 183		197-199, 211	⊕
95	99		110, 113-114, 117-119	124, 127, 129	132-133, 135-143, 147, 149-157	159-177	180-181, 183		197-211	⊕
					150					⊕ ⊕
95	98	101-103	110, 113-114, 117-118	124-126, 129	131-133, 135, 137, 139-140, 144, 148-155, 157	159-160, 162-172, 175-177	182-183		197, 203-204, 206-208, 210-211	⊕
			118	129	145	177				⊕
		101-102			145, 147					⊕
	97	104-107	110, 113, 118	125, 129	144, 148, 157	166-167, 176-177	180, 182		211	⊕
	97		110-112, 114-115, 117, 119-121	125-129	157	175	179			⊕
			113-114, 119	129	144, 148-149	166				⊕
					146	177	182			⊕
					145	177				⊕
			113		146	166, 177				⊕
					146	177				⊕
					146	177				⊕
							178			⊕
										⊕
95	98		110, 113-114, 117-119	126-127, 129	131, 157	158-168	185-186		210-212	⊕ 1/4"

## Ergonic, primul mâner ce se adaptează după mâna utilizatorului!

Ergonic, az első markolat, amely alkalmazkodik a felhasználó tenyeréhez



## Mâner fin, fără îmbinări, pentru confort maxim

sorjamentes végződés a maximális kényelemért

## Mâna și mânerul interacționează, fără efort

marok és markolat között kisebb terhelés

## Serie 400 **ERgonic**® (pat.)

EP 1963072

**Mai puternic / Erősebb**  
**adaptabil / rugalmas**  
**cu adevărat ergonomic / valóban ergonomikus**

## Piulițe hexagonale de strângere disponibile la Seria 410

hatszögörösítés a 410-es sorozaton

## Lame produse din oțel crom-molibden-vanadium

a pengék anyaga  
króm-molibdén vanádium acél

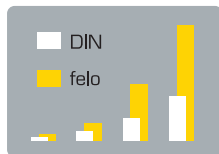

## Torsiune superioară ce depășește cerințele normelor DIN și ISO cu până la 100%

több mint 100%-kal meghaladja az ISO és DIN szabványok követelményeit

## Cod EAN pe fiecare produs

EAN vonalkód minden terméken



## Vârf negru pentru precizie

bevonatmentes végződés a pontos illesztésért

## Design mâner anti-roll

gurulásmentes markolat kialakítás

## Gaură de agățare pentru depozitarea facilă sau efect de levier

furat a könnyebb tárolásért és erőkar alkalmazásáért

## Simbolurile aferente șuruburilor imprimate pe mâner

megkülönböztető jelek a markolaton



## Miez rezistent la impact cu lungime integrală

ütésálló markolat váz







Există design-uri ergonomice numeroase pentru mânere, dar, este întotdeauna mâna utilizatorului cea ce trebuie să se adapteze la forma mânerului. **ERGONIC** este singurul mâner ce ia forma mâinii utilizatorului!

Számos ergonómiai markolatforma létezik, de mindig a felhasználó keze az, amihez illeszkednie kell a szerszámnak. Az **ERGONIC** az egyetlen markolat, ami egyedileg illeszkedik minden tenyérbe.

**Noul standard în ergonomie,  
transmiterea torsiunii și capacitate de reacție!**

*Az új szabvány az ergonómiában,  
a legnagyobb nyomatékátvitel a legnagyobb kényelem mellett.*

**ERGONIC**<sup>®</sup>

**Miezul mânerului rezistent la impact este învelit cu un elastomer rezistent la zgârieturi și elastic ce conține celule de material plastic foarte flexibil.**

*A markolat ütészálló vázát körülöleli egy karcolásálló, nagy flexibilitású, zselés anyag.*



**Mânerul se potrivește perfect în mâna tot timpul. Mânerul și mâna interacționează, cauzând mai puțină presiune și oboseală în timpul muncii și transmitând maximul de torsiune! Responsivitatea materialului rezultă într-o sensibilitate mărită și un control perfect al torsiunii.**

*A markolat mindig tökéletesen illeszkedik a tenyérbe. Marok es markolat között kisebb a terhelés es kevésbé fáradtságos a munka, teljes nyomatékátvitel mellett. Az markolat anyaga érzékenyen reagál a kifejett erőre, így tökéletesen kontrollálható a nyomaték.*



**felo**  
Innovations



felo  
Innovations



## 410



									Item No		EAN-Code
	4,0 x 0,8	75	94	30	4,0	12			<b>410 042 40</b>	47	40 07157 53121 6
	5,5 x 1,0	100	101	33	5,0	12			<b>410 553 40</b>	88	40 07157 52785 1
	6,5 x 1,2	125	106	36	6,35	12			<b>410 654 40</b>	113	40 07157 52787 5
	8,0 x 1,2	150	112	39	8,0	12			<b>410 085 40</b>	167	40 07157 52789 9
	10,0 x 1,6	175	112	39	8,0	6			<b>410 105 40</b>	177	40 07157 53125 4
	12,0 x 2,0	200	112	39	10,0	6			<b>410 127 40</b>	253	40 07157 53127 8

## 411



felo  
Innovations



PZ							Item No		EAN-Code
1	80	94	30	5,0	12		<b>411 102 40</b>	60	40 07157 52791 2
2	100	106	36	6,35	12		<b>411 203 40</b>	106	40 07157 52793 6
3	150	112	39	8,0	6		<b>411 305 40</b>	172	40 07157 53129 2

## 412



felo  
Innovations



PH							Item No		EAN-Code
1	80	94	30	5,0	12		<b>412 102 40</b>	60	40 07157 52795 0
2	100	106	36	6,35	12		<b>412 203 40</b>	105	40 07157 52797 4
3	150	112	39	8,0	6		<b>412 305 40</b>	169	40 07157 53131 5
4	150	112	39	10,0	6		<b>412 405 40</b>	228	40 07157 63079 7

## 410



felo  
Innovations



		Item No		EAN-Code
<b>Set 6-pcs. / Satz 6-tlg.</b>		<b>410 961 48</b>	538	40 07157 53167 4
(1 x) <b>400:</b>	3,0 x 80			
(3 x) <b>410:</b>	4,0 x 75 / 5,5 x 100 / 6,5 x 125			
(2 x) <b>412:</b>	PH 1 x 80 / PH 2 x 100			

410



felo  
Innovations

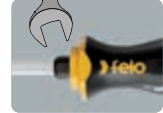

Set 6-pcs. / Satz 6-tlg.

Item No

410 962 48



542

EAN-Code

40 07157 53513 9



(1 x) 400: 3,0 x 80

(3 x) 410: 4,0 x 75 / 5,5 x 100 / 6,5 x 125

(2 x) 411: PZ 1 x 80 / PZ 2 x 100

410



felo  
Innovations



Set 6-pcs. / Satz 6-tlg.

Item No

410 963 48



630

EAN-Code

40 07157 53673 0



(2 x) 410: 5,5 x 100 / 6,5 x 125

(2 x) 411: PZ 1 x 80 / PZ 2 x 100

(2 x) 412: PH 1 x 80 / PH 2 x 100





## 400



											Item No		EAN-Code
	2,5 x 0,4	75	86	25	2,5	12		<b>400 022 10</b>	27	40 07157 53679 2			
	3,0 x 0,5	80	86	25	3,0	12		<b>400 032 10</b>	30	40 07157 53117 9			
	3,5 x 0,6	100	86	25	3,5	12		<b>400 353 10</b>	33	40 07157 53119 3			
	4,0 x 0,8	100	94	30	4,0	12		<b>400 043 10</b>	49	40 07157 53611 2			
	5,0 x 0,8	150	101	33	5,0	12		<b>400 055 10</b>	75	40 07157 53619 8			
	5,5 x 1,0	125	101	33	5,0	12		<b>400 554 10</b>	72	40 07157 53621 1			
	5,5 x 1,0	150	101	33	5,0	12		<b>400 555 10</b>	82	40 07157 53623 5			
	6,0 x 1,2	100	106	36	6,0	12		<b>400 063 10</b>	79	40 07157 57589 0			
	6,0 x 1,2	150	106	36	6,0	12		<b>400 065 10</b>	102	40 07157 57591 3			
	6,0 x 1,2	200	106	36	6,0	12		<b>400 067 10</b>	112	40 07157 57593 7			
	6,5 x 1,2	100	106	36	6,0	12		<b>400 653 10</b>	79	40 07157 53627 3			
	6,5 x 1,2	150	106	36	6,0	12		<b>400 655 10</b>	102	40 07157 52799 8			
	6,5 x 1,2	200	106	36	6,0	12		<b>400 657 10</b>	112	40 07157 53629 7			
	8,0 x 1,2	175	112	39	7,0	12		<b>400 086 10</b>	135	40 07157 52801 8			
	10,0 x 1,6	200	112	39	8,0	6		<b>400 107 10</b>	162	40 07157 53681 5			



## 401



PZ										Item No		EAN-Code
	1	80	94	30	4,5	12		<b>401 102 10</b>	50	40 07157 53683 9		
	2	100	106	36	6,0	12		<b>401 203 10</b>	92	40 07157 53685 3		
	3	150	112	39	8,0	6		<b>401 305 10</b>	148	40 07157 53687 7		



**Professional users in particular appreciate the innovative features of our tools.**

*Professionelle Anwender wissen die innovativen Eigenschaften der Felo Werkzeuge zu schätzen.*



## 402



PH						Item No		EAN-Code
<b>1</b>	80	94	30	4,5	12	<b>402 102 10</b>	50	40 07157 52803 2
<b>2</b>	100	106	36	6,0	12	<b>402 203 10</b>	92	40 07157 52805 6
<b>2</b>	150	106	36	6,0	12	<b>402 205 10</b>	103	40 07157 53637 2
<b>2</b>	200	106	36	6,0	6	<b>402 207 10</b>	114	40 07157 53639 6
<b>3</b>	150	112	39	8,0	6	<b>402 305 10</b>	146	40 07157 53689 1



## 404



SQ						Item No		EAN-Code
<b>0</b> (1,75 mm)	100	94	30	3,0	12	<b>404 000 40</b>	44	40 07157 60309 8
<b>1</b> (2,30 mm)	120	94	30	4,5	12	<b>404 100 40</b>	56	40 07157 53507 8
<b>2</b> (2,80 mm)	160	106	36	5,0	12	<b>404 200 40</b>	91	40 07157 53509 2
<b>3</b> (3,30 mm)	160	106	36	6,0	12	<b>404 300 40</b>	105	40 07157 53511 5



## 408



Torx®						Item No		EAN-Code
<b>7</b>	60	86	25	3,0	12	<b>408 071 40</b>	28	40 07157 52807 0
<b>8</b>	60	86	25	3,0	12	<b>408 083 40</b>	28	40 07157 52809 4
<b>9</b>	60	86	25	3,5	12	<b>408 093 40</b>	28	40 07157 52811 7
<b>10</b>	100	86	25	3,5	12	<b>408 103 40</b>	33	40 07157 52813 1
<b>15</b>	100	94	30	4,0	12	<b>408 153 40</b>	50	40 07157 52815 5
<b>20</b>	100	101	33	5,0	12	<b>408 203 40</b>	68	40 07157 52817 9
<b>25</b>	100	106	36	5,0	12	<b>408 253 40</b>	82	40 07157 52819 3
<b>27</b>	100	106	36	5,0	12	<b>408 273 40</b>	82	40 07157 52821 6
<b>30</b>	115	112	39	6,0	6	<b>408 303 40</b>	103	40 07157 52823 0
<b>40</b>	125	112	39	8,0	6	<b>408 404 40</b>	136	40 07157 52825 4



## 407



Torx®TR						Item No		EAN-Code
<b>10</b>	100	86	25	3,5	12	<b>407 103 40</b>	33	40 07157 60903 8
<b>15</b>	100	94	30	4,0	12	<b>407 153 40</b>	50	40 07157 60905 2
<b>20</b>	100	101	33	4,0	12	<b>407 203 40</b>	68	40 07157 60907 6
<b>25</b>	100	106	36	5,0	12	<b>407 253 40</b>	82	40 07157 60909 0

## M-TEC

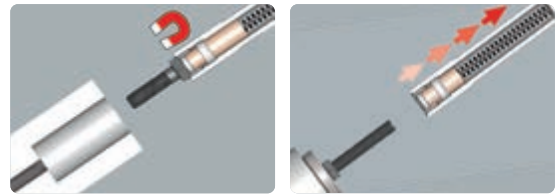

**felo**  
Innovations

428



mm						Item No		EAN-Code
5,5	110	94	30		12	<b>428 055 30</b>	84	40 07157 60285 5
6	110	94	30		12	<b>428 060 30</b>	87	40 07157 60349 4
7	110	94	30		12	<b>428 070 30</b>	97	40 07157 60287 9
8	110	101	33		12	<b>428 080 30</b>	110	40 07157 60289 3
10	125	101	33		12	<b>428 100 30</b>	126	40 07157 60291 6
13	125	106	36		12	<b>428 130 30</b>	187	40 07157 60293 0



**felo**  
Innovations



429



mm						Item No		EAN-Code
5	170	106	36		6	<b>429 050 40</b>	148	40 07157 60355 5
6	170	106	36		6	<b>429 060 40</b>	148	40 07157 60357 9
7	170	106	36		6	<b>429 070 40</b>	148	40 07157 60359 3
8	170	106	36		6	<b>429 080 40</b>	151	40 07157 60361 6
10	170	106	36		6	<b>429 100 40</b>	151	40 07157 60363 0
1/4"	170	106	36		6	<b>429 635 40</b>	146	40 07157 60365 4



438



felo Innovations

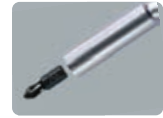

1/4"

	100	101	33	6	Item No		EAN-Code
1/4"					438 125 40	102	40 07157 53711 9

497



felo Innovations



1/4"

	100	101	33	6	Item No		EAN-Code
Adapter for sockets 1/4" / Adapter für Steckschlüsseinsätze 1/4"					497 110 40	107	40 07157 61479 7

Stubby



felo Innovations

5,5 x 25  
PH 2

	25	60	21	12	Item No		EAN-Code
Stubby							
5,5 x 25					400 550 10	36	40 07157 61509 1
PH 2					402 020 10	38	40 07157 61511 4

Stubby



felo Innovations

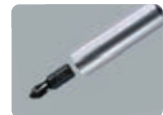

1/4"

	18	62	25	12	Item No		EAN-Code
Stubby Bitholder 1/4" / Stubby Bithalter							
1/4"					438 026 40	48	40 07157 61727 9

497



felo Innovations









	94	30	12	Item No		EAN-Code
Bottle Opener / Flaschenöffner						
				497 200 00	59	40 07157 62405 5



400









	Item No		EAN-Code
<b>Ergonic XXL-Rack 17-pcs. / Display 17-tlg.</b>	<b>400 917 43</b>	2332	40 07157 60391 3
(5 x) <b>400:</b> 3,0 x 80 / 4,0 x 100 / 5,5 x 125 / 6,5 x 150 / 8,0 x 175			
(2 x) <b>401:</b> PZ 1 x 80 / PZ 2 x 100			
(2 x) <b>402:</b> PH 1 x 80 / PH 2 x 100			
(2 x) <b>413:</b> 3,5 x 100 / 4,0 x 100    AC 1000V IEC 60900 : 2012			
(2 x) <b>414:</b> PH 1 x 80 / PH 2 x 100    AC 1000V IEC 60900 : 2012			
(4 x) <b>408:</b> Torx® 10 x 100 / Torx® 15 x 100 / Torx® 20 x 100 / Torx® 25 x 100			
(1 x) <b>Steel Rack / Werkzeughalter (Stahl)</b>			



400



	Item No		EAN-Code
<b>Ergonic XL-Rack 10-pcs. / Display 10-tlg.</b>	<b>400 910 13</b>	1296	40 07157 63633 1
(3 x) <b>400:</b> 4,0 x 100 / 5,5 x 125 / 6,5 x 150			
(2 x) <b>402:</b> PH 1 x 80 / PH 2 x 100			
(1 x) <b>413:</b> 3,5 x 100    AC 1000V IEC 60900 : 2012			
(3 x) <b>408:</b> Torx® 15 x 100 / Torx® 20 x 100 / Torx® 25 x 100			
(1 x) <b>361:</b> <b>Mains testing screwdriver / Profi-Spannungsprüfer VDE 0680 150 V - 250 V</b>			
(1 x) <b>Steel Rack / Werkzeughalter (Stahl)</b>			

<b>Ergonic XL-Rack 10-pcs. / Display 10-tlg.</b>	<b>400 910 43</b>	1296	40 07157 63635 5
(3 x) <b>400:</b> 4,0 x 100 / 5,5 x 125 / 6,5 x 150			
(2 x) <b>401:</b> PZ 1 x 80 / PZ 2 x 100			
(1 x) <b>413:</b> 3,5 x 100    AC 1000V IEC 60900 : 2012			
(3 x) <b>408:</b> Torx® 15 x 100 / Torx® 20 x 100 / Torx® 25 x 100			
(1 x) <b>361:</b> <b>Mains testing screwdriver / Profi-Spannungsprüfer VDE 0680 150 V - 250 V</b>			
(1 x) <b>Steel Rack / Werkzeughalter (Stahl)</b>			





**felo**  
Innovations

400



	Item No		EAN-Code
<b>Set 7-pcs. / Satz 7-tlg.</b>	<b>400 971 18</b>	602	40 07157 53695 2
[4 x] <b>400:</b>	3,5 x 100 / 4,0 x 100 / 5,5 x 125 / 6,5 x 150		
[1 x] <b>401:</b>	PZ 2 x 100		
[2 x] <b>402:</b>	PH 1 x 80 / PH 2 x 100		



**felo**  
Innovations

400



	Item No		EAN-Code
<b>toolcase 6-pcs. / Koffer 6-tlg.</b>	<b>400 106 36</b>	682	40 07157 62409 3
[2 x] <b>400:</b>	4,0 x 100 / 6,5 x 100		
[2 x] <b>401:</b>	PZ 1 x 80 / PZ 2 x 100		
[2 x] <b>402:</b>	PH 1 x 80 / PH 2 x 100		



**felo**  
Innovations

400



	Item No		EAN-Code
<b>toolcase 6-pcs. / Koffer 6-tlg.</b>	<b>400 206 36</b>	652	40 07157 62411 6
[4 x] <b>400:</b>	3,0 x 80 / 4,0 x 100 / 5,5 x 125 / 6,5 x 100		
[2 x] <b>402:</b>	PH 1 x 80 / PH 2 x 100		



**felo**  
Innovations

400



	Item No		EAN-Code
<b>Set 6-pcs. / Satz 6-tlg.</b>	<b>400 961 18</b>	548	40 07157 53691 4
(2 x) <b>400:</b> 4,0 x 100 / 6,5 x 150			
(2 x) <b>401:</b> PZ 1 x 80 / PZ 2 x 100			
(2 x) <b>402:</b> PH 1 x 80 / PH 2 x 100			



**felo**  
Innovations

400



	Item No		EAN-Code
<b>Set 5-pcs. / Satz 5-tlg.</b>	<b>400 953 18</b>	492	40 07157 57539 5
(3 x) <b>400:</b> 4,0 x 100 / 5,5 x 125 / 6,5 x 150			
(2 x) <b>401:</b> PZ 1 x 80 / PZ 2 x 100			



**felo**  
Innovations

400



	Item No		EAN-Code
<b>Set 5-pcs. / Satz 5-tlg.</b>	<b>400 951 18</b>	492	40 07157 53693 8
(3 x) <b>400:</b> 4,0 x 100 / 5,5 x 125 / 6,5 x 150			
(2 x) <b>402:</b> PH 1 x 80 / PH 2 x 100			

# 400



**Set 3-pcs. / Satz 3-tlg.**  
 (2 x ) **400:** 5,5 x 125 / 6,5 x 150  
 (1 x ) **402:** PH 2 x 100

Item No		EAN-Code
<b>400 931 18</b>	312	40 07157 53701 0

# 404



**Set 3-pcs. / Satz 3-tlg.**  
 (3 x ) **404:** SQ 1 / SQ 2 / SQ 3

Item No		EAN-Code
<b>404 931 48</b>	269	40 07157 53517 7

# 401



**Set 5-pcs. / Satz 5-tlg.**  
 (2 x ) **401:** PZ 1 x 80 / PZ 2 x 100  
 (3 x ) **408:** Torx® 15 / Torx® 20 / Torx® 25

Item No		EAN-Code
<b>401 951 48</b>	442	40 07157 63351 4

# 402



**Set 5-pcs. / Satz 5-tlg.**  
 (2 x ) **402:** PH 1 x 80 / PH 2 x 100  
 (3 x ) **408:** Torx® 15 / Torx® 20 / Torx® 25

Item No		EAN-Code
<b>402 951 48</b>	442	40 07157 63353 8



408

**felo**  
Innovations



	Item No		EAN-Code
<b>Set 6-pcs. Torx® / Satz 6-tlg.</b>	<b>408 961 48</b>	400	40 07157 53165 0
[6 x ] <b>408:</b> Torx® 8 / Torx® 9 / Torx® 10 / Torx® 15 / Torx® 20 / Torx® 25			



408

**felo**  
Innovations



	Item No		EAN-Code
<b>Set 6-pcs. Torx® / Satz 6-tlg.</b>	<b>408 962 48</b>	572	40 07157 63355 2
[6 x ] <b>408:</b> Torx® 10 / Torx® 15 / Torx® 20 / Torx® 25 / Torx® 30 / Torx® 40			



408

**felo**  
Innovations



	Item No		EAN-Code
<b>Set 3-pcs. Torx® / Satz 3-tlg.</b>	<b>408 931 48</b>	186	40 07157 53171 1
[3 x ] <b>408:</b> Torx® 10 / Torx® 15 / Torx® 20			



**M-TEC** 

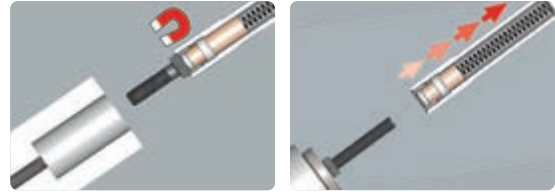

**M-Tec  
428**

**felo**  
Innovations



	Item No		EAN-Code
toolcase 6-pcs. / Koffer 6-tlg.	<b>428 106 36</b>	952	40 07157 61373 8
(6 x ) 428: 5,5 x 110 / 6 x 110 / 7,0 x 110 / 8,0 x 110 10,0 x 125 / 13,0 x 125			



### Capac de oțel

acélkupak



### Material exterior soft-grip plăcut pentru torsiune maximă

kellemes tapintású markolat, a legnagyobb nyomatékátvitellel

## Cea mai puternică din seria 500 Legerősebb az 500-as sorozatból Serie 550

Capac de oțel / acélkupak

lamă cu lungime integrală / teljes hosszúságú penge

piuliță hexagonală / hatszögerősítés

lamă hexagonală / hatlapú penge



### piuliță hexagonală

hatszögerősítés

### Design mâner anti-roll

gurulásmentes markolat kialakítás



### Lame hexagonale fabricate din oțel crom-molibden-vanadium

a pengék anyaga króm-molibdén vanádium acél



### Torsiune superioară ce depășește cerințele normelor DIN și ISO cu până la 100%

több mint 100%-kal meghaladja az ISO és DIN szabványok követelményeit

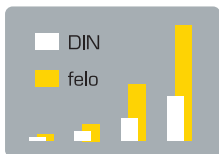

4 007157 320940

### Cod EAN pe fiecare produs

EAN vonalkód minden terméken

### Lamă cu lungime integrală

teljes hosszúságú penge

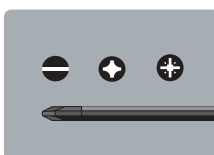
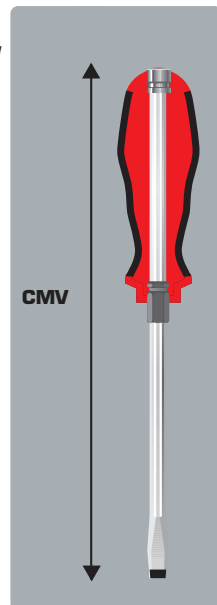

### Vărf negru pentru precizie

bevonatmentes végződés a pontos illesztésért



## 550



							Item No		EAN-Code
<b>4,5 x 0,8</b>	100	90	29	5,0	12		<b>550 045 40</b>	84	40 07157 50699 3
<b>5,5 x 1,0</b>	100	99	34	5,0	12		<b>550 055 40</b>	101	40 07157 32354 5
<b>6,5 x 1,2</b>	125	99	34	6,35	12		<b>550 065 40</b>	128	40 07157 32356 9
<b>8,0 x 1,2</b>	155	105	38	8,0	6		<b>550 080 40</b>	202	40 07157 32358 3
<b>9,0 x 1,6</b>	165	105	38	8,0	6		<b>550 090 40</b>	204	40 07157 50701 3
<b>10,0 x 1,6</b>	175	105	38	8,0	6		<b>550 100 40</b>	211	40 07157 32360 6
<b>12,0 x 2,0</b>	200	105	38	10,0	6		<b>550 120 40</b>	291	40 07157 32362 0



## 551



PZ							Item No		EAN-Code
<b>1</b>	90	90	29	5,0	12		<b>551 102 40</b>	82	40 07157 51701 2
<b>2</b>	100	99	34	6,35	12		<b>551 203 40</b>	122	40 07157 32364 4
<b>3</b>	155	105	38	8,0	6		<b>551 305 40</b>	202	40 07157 32366 8



## 552



PH							Item No		EAN-Code
<b>1</b>	90	90	29	5,0	12		<b>552 102 40</b>	82	40 07157 50703 7
<b>2</b>	100	99	34	6,35	12		<b>552 203 40</b>	122	40 07157 32368 2
<b>3</b>	155	105	38	8,0	6		<b>552 305 40</b>	201	40 07157 32370 5



550



	Item No		EAN-Code
<b>Set 6-pcs. / Satz 6-tlg.</b>	<b>550 961 47</b>	1145	40 07157 53709 6
(3 x ) <b>550:</b>	6,5 x 1,2 x 125 / 8,0 x 1,2 x 155 / 10,0 x 1,6 x 175		
(3 x ) <b>552:</b>	PH 1 x 90 / PH 2 x 100 / PH 3 x 155		



550



	Item No		EAN-Code
<b>Set 5-pcs. / Satz 5-tlg.</b>	<b>550 952 48</b>	633	40 07157 50707 5
(3 x ) <b>550:</b>	4,5 x 100 / 5,5 x 100 / 6,5 x 125		
(2 x ) <b>552:</b>	PH 1 x 90 / PH 2 x 100		



550



	Item No		EAN-Code
<b>Set 5-pcs. / Satz 5-tlg.</b>	<b>550 951 48</b>	870	40 07157 32386 6
(3 x ) <b>550:</b>	5,5 x 100 / 6,5 x 125 / 8,0 x 155		
(2 x ) <b>552:</b>	PH 2 x 100 / PH 3 x 155		



**550**



**Set 3-pcs. / Satz 3-tlg.**

(3 x) **550**      5,5 x 100 / 6,5 x 125 / 8 x 155

**Item No**

**550 932 44**



481

**EAN-Code**

40 07157 53669 3



**Reliability and a long  
lifespan are essential for  
good tools.**

*Zuverlässigkeit und lange  
Lebensdauer machen gutes  
Werkzeug aus.*

*Dr. von Kitz*



**Miez rezistent la impact cu lungime integrală**  
 ütészálló markolat vég

**Mâner fin, fără  
 îmbinări, pentru  
 confort maxim**

sorjamentes végződés a  
 maximális kényelemért



**Material exterior soft-grip plăcut  
 pentru torsiune maximă**

kellemes tapintású markolat,  
 a legnagyobb nyomatékátvitellel

**Leaderii in designul mânerului /**

A korszakalkotó markolatforma

**calitatea lamei / minőségi penge**

**tehnologia bi-component /**

kétkomponenses technológia

**Design mâner  
 anti-roll**

gurulásmentes  
 markolat kialakítás

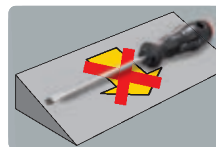

**Lame fabricate din oțel  
 crom-molybden-vanadium**

a pengék anyaga króm-molibdén  
 vanádium acél

**Gaură de agățare pentru  
 depozitarea facilă sau  
 efect de levier**

furat a könnyebb tárolásért és  
 erőkar alkalmazásáért



**Design ergonomic rafinat**

ergonomikus, kifinomult forma

**Torsiune superioară ce  
 depășește cerințele  
 normelor DIN și ISO  
 cu până la 100%**

több mint 100%-kal  
 meghaladja az ISO és DIN  
 szabványok követelményeit

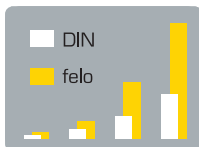

**Cod EAN pe fiecare produs**

EAN vonalkód minden terméken



**Vârf negru pentru precizie**

bevonatmentes végződés a  
 pontos illesztésért



## Originalul / Az eredeti Serie 500

## 500



								EAN-Code
<b>2,5 x 0,4</b>	75	80	25	2,5	12		<b>500 022 10</b>	27 40 07157 22091 2
<b>3,0 x 0,5</b>	80	80	25	3,0	12		<b>500 032 10</b>	29 40 07157 22092 9
<b>3,5 x 0,6</b>	100	80	25	3,5	12		<b>500 353 10</b>	33 40 07157 22093 6
<b>4,0 x 0,8</b>	100	90	29	4,0	12		<b>500 043 10</b>	48 40 07157 22094 3
<b>4,0 x 0,8</b>	200	90	29	4,0	12		<b>500 047 10</b>	58 40 07157 50693 1
<b>4,0 x 0,8</b>	300	90	29	4,0	12		<b>500 049 10</b>	68 40 07157 51379 3
<b>5,0 x 0,8</b>	150	99	34	5,0	12		<b>500 505 10</b>	76 40 07157 50572 9
<b>5,5 x 1,0</b>	125	99	34	5,0	12		<b>500 554 10</b>	79 40 07157 22095 0
<b>5,5 x 1,0</b>	150	99	34	5,0	12		<b>500 556 10</b>	83 40 07157 51811 8
<b>5,5 x 1,0</b>	200	99	34	5,0	12		<b>500 557 10</b>	92 40 07157 53697 6
<b>5,5 x 1,0</b>	300	99	34	5,0	12		<b>500 559 10</b>	111 40 07157 50695 5
<b>6,5 x 1,2</b>	100	99	34	6,0	12		<b>500 656 10</b>	77 40 07157 51841 5
<b>6,5 x 1,2</b>	150	99	34	6,0	12		<b>500 655 10</b>	89 40 07157 22096 7
<b>6,5 x 1,2</b>	200	99	34	6,0	12		<b>500 657 10</b>	102 40 07157 51843 9
<b>6,5 x 1,2</b>	500	105	39	6,0	6		<b>500 610 10</b>	190 40 07157 53699 0
<b>8,0 x 1,2</b>	175	105	39	7,0	12		<b>500 086 10</b>	127 40 07157 22097 4
<b>8,0 x 1,2</b>	300	105	39	8,0	6		<b>500 088 10</b>	198 40 07157 51809 5
<b>8,0 x 1,6</b>	175	105	39	8,0	6		<b>500 096 10</b>	149 40 07157 22098 1
<b>10,0 x 1,6</b>	200	105	39	8,0	6		<b>500 107 10</b>	156 40 07157 50697 9

## 501



PZ							EAN-Code
<b>0</b>	60	80	25	3,0	12	<b>501 001 10</b>	28 40 07157 22100 1
<b>1</b>	80	90	29	4,5	12	<b>501 102 10</b>	49 40 07157 22101 8
<b>2</b>	100	99	34	6,0	12	<b>501 203 10</b>	79 40 07157 22102 5
<b>2</b>	200	99	34	6,0	6	<b>501 207 10</b>	102 40 07157 22105 6
<b>2</b>	300	99	34	6,0	6	<b>501 209 10</b>	125 40 07157 51769 2
<b>3</b>	150	105	39	8,0	6	<b>501 305 10</b>	140 40 07157 31330 0
<b>4</b>	150	105	39	10,0	6	<b>511 405 40</b>	218 40 07157 30856 6

## 502



PH							EAN-Code
<b>0</b>	60	80	25	3,0	12	<b>502 001 10</b>	28 40 07157 22106 3
<b>1</b>	80	90	29	4,5	12	<b>502 102 10</b>	48 40 07157 22107 0
<b>1</b>	200	90	29	4,5	12	<b>502 107 10</b>	65 40 07157 22111 7
<b>2</b>	100	99	34	6,0	12	<b>502 203 10</b>	80 40 07157 22108 7
<b>2</b>	150	99	34	6,0	12	<b>502 205 10</b>	90 40 07157 51845 3
<b>2</b>	200	99	34	6,0	6	<b>502 207 10</b>	101 40 07157 22112 4
<b>2</b>	300	99	34	6,0	6	<b>502 209 10</b>	123 40 07157 51381 6
<b>2</b>	500	99	34	6,0	6	<b>502 210 10</b>	187 40 07157 57813 6
<b>3</b>	150	105	39	8,0	6	<b>502 305 10</b>	138 40 07157 31331 7



## Stubby



						Item No		EAN-Code
<b>5,5 x 1,0</b>	25	57	35	5,0	12	<b>500 550 10</b>	35	40 07157 22099 8
<b>PZ 1</b>	25	57	35	4,5	12	<b>501 010 10</b>	33	40 07157 22103 2
<b>PZ 2</b>	25	57	35	6,0	12	<b>501 020 10</b>	37	40 07157 22104 9
<b>PH 1</b>	25	57	35	4,5	12	<b>502 010 10</b>	33	40 07157 22109 4
<b>PH 2</b>	25	57	35	6,0	12	<b>502 020 10</b>	38	40 07157 22110 0



## 507





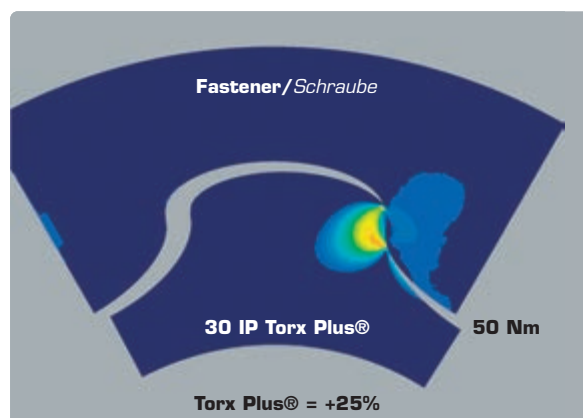
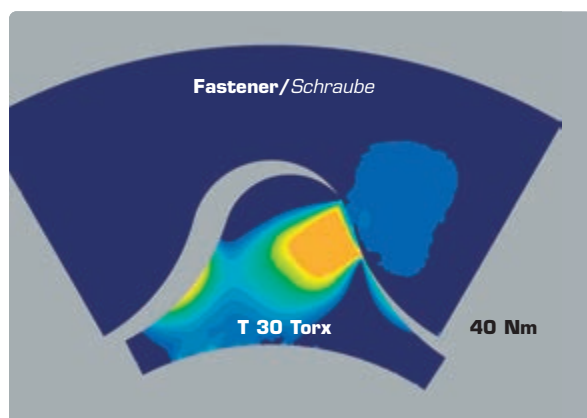



Torx® TR						Item No		EAN-Code
<b>10</b>	100	80	25	3,5	12	<b>507 103 40</b>	33	40 07157 32234 0
<b>15</b>	100	90	29	4,0	12	<b>507 153 40</b>	47	40 07157 32236 4
<b>20</b>	100	99	34	4,0	12	<b>507 203 40</b>	69	40 07157 32238 8
<b>25</b>	100	99	34	5,0	12	<b>507 253 40</b>	68	40 07157 32240 1
<b>27</b>	100	99	34	5,0	12	<b>507 273 40</b>	70	40 07157 32242 5
<b>30</b>	115	105	39	6,0	6	<b>507 303 40</b>	98	40 07157 32244 9
<b>40</b>	125	105	39	8,0	6	<b>507 404 40</b>	130	40 07157 32246 3









# 508



Torx®						Item No		EAN-Code
<b>5</b>	60	68	20	3,0	12	<b>508 051 40</b>	15	40 07157 22188 9
<b>6</b>	60	68	20	3,0	12	<b>508 061 40</b>	15	40 07157 22154 4
<b>7</b>	60	80	25	3,0	12	<b>508 071 40</b>	28	40 07157 22156 8
<b>8</b>	60	80	25	3,0	12	<b>508 083 40</b>	28	40 07157 22157 5
<b>9</b>	60	80	25	3,5	12	<b>508 093 40</b>	28	40 07157 22158 2
<b>10</b>	100	80	25	3,5	12	<b>508 103 40</b>	33	40 07157 22159 9
<b>15</b>	100	90	29	4,0	12	<b>508 153 40</b>	48	40 07157 22160 5
<b>20</b>	100	99	34	5,0	12	<b>508 203 40</b>	69	40 07157 22161 2
<b>25</b>	100	99	34	5,0	12	<b>508 253 40</b>	69	40 07157 22162 9
<b>27</b>	100	99	34	5,0	12	<b>508 273 40</b>	70	40 07157 22163 6
<b>30</b>	115	105	39	6,0	6	<b>508 303 40</b>	96	40 07157 22164 3
<b>40</b>	125	105	39	8,0	6	<b>508 404 40</b>	129	40 07157 22165 0
<b>45</b>	125	105	39	8,0	6	<b>508 454 40</b>	129	40 07157 22166 7

# 509



Torx Plus®						Item No		EAN-Code
<b>6 IP</b>	60	68	20	3,0	12	<b>509 061 40</b>	17	40 07157 51319 9
<b>7 IP</b>	60	80	25	3,0	12	<b>509 071 40</b>	28	40 07157 51321 2
<b>8 IP</b>	60	80	25	3,0	12	<b>509 083 40</b>	29	40 07157 51323 6
<b>9 IP</b>	60	80	25	3,0	12	<b>509 093 40</b>	30	40 07157 51325 0
<b>10 IP</b>	100	80	25	3,5	12	<b>509 103 40</b>	33	40 07157 51327 4
<b>15 IP</b>	100	90	29	4,0	12	<b>509 153 40</b>	48	40 07157 51329 8
<b>20 IP</b>	100	99	34	5,0	12	<b>509 203 40</b>	69	40 07157 51331 1
<b>25 IP</b>	100	99	34	5,0	12	<b>509 253 40</b>	69	40 07157 51333 5
<b>27 IP</b>	100	99	34	5,0	12	<b>509 273 40</b>	70	40 07157 51335 9
<b>30 IP</b>	115	105	39	6,0	6	<b>509 303 40</b>	97	40 07157 51337 3
<b>40 IP</b>	125	105	39	8,0	6	<b>509 404 40</b>	130	40 07157 51339 7

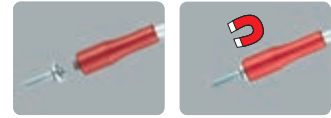

## 500



						Item No		EAN-Code
<b>3,0 x 0,5</b>	80	80	25	3,0	6	<b>500 032 30</b>	30	40 07157 51681 7
<b>3,0 x 0,5</b>	200	80	25	3,0	6	<b>500 037 30</b>	36	40 07157 51981 8
<b>3,5 x 0,6</b>	100	80	25	3,5	6	<b>500 353 30</b>	34	40 07157 51683 1
<b>3,5 x 0,6</b>	250	80	25	3,5	6	<b>500 358 30</b>	46	40 07157 51983 2
<b>4,0 x 0,8</b>	100	90	29	4,0	6	<b>500 043 30</b>	50	40 07157 51685 5
<b>4,0 x 0,8</b>	200	90	29	4,0	6	<b>500 047 30</b>	60	40 07157 51757 9

## 501



PZ						Item No		EAN-Code
<b>1</b>	80	90	29	4,5	6	<b>501 102 30</b>	52	40 07157 51677 0
<b>2</b>	100	99	34	6,0	6	<b>501 203 30</b>	84	40 07157 51679 4
<b>2</b>	200	99	34	6,0	6	<b>501 207 30</b>	108	40 07157 51759 3

## 502



PH						Item No		EAN-Code
<b>1</b>	80	90	29	4,5	6	<b>502 102 30</b>	50	40 07157 51673 2
<b>1</b>	200	90	29	4,5	6	<b>502 107 30</b>	68	40 07157 51985 6
<b>2</b>	100	99	34	6,0	6	<b>502 203 30</b>	84	40 07157 51675 6
<b>2</b>	200	99	34	6,0	6	<b>502 207 30</b>	106	40 07157 51761 6

## 508



Torx®						Item No		EAN-Code
<b>10</b>	100	80	25	3,5	6	<b>508 103 30</b>	34	40 07157 51665 7
<b>15</b>	100	90	29	4,0	6	<b>508 153 30</b>	50	40 07157 51667 1
<b>20</b>	100	99	34	5,0	6	<b>508 203 30</b>	72	40 07157 51669 5
<b>25</b>	100	99	34	5,0	6	<b>508 253 30</b>	73	40 07157 51671 8

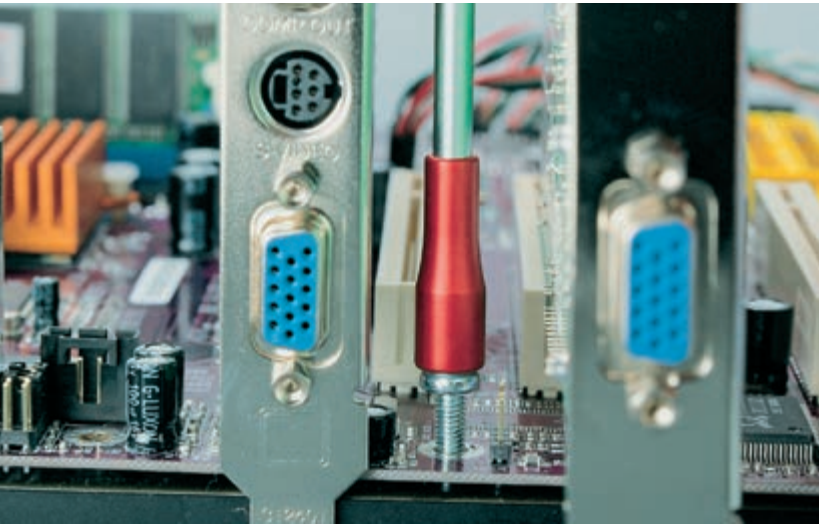

### 520



<b>4,0 x 0,8</b>	155	90	29	4,0	6	
<b>5,5 x 1,0</b>	155	99	34	5,5	6	

Item No



EAN-Code

**520 045 10**

66

40 07157 50072 4

**520 055 10**

92

40 07157 50074 8

### 522



PH						
<b>1</b>	155	90	29	4,0	6	
<b>2</b>	155	99	34	5,5	6	

Item No



EAN-Code

**522 105 10**

66

40 07157 50076 2

**522 205 10**

91

40 07157 50078 6

### 538



**felo**  
Innovations



Star-					
<b>100</b>	100	99	34	6	

Item No



EAN-Code

**538 100 40**

102

40 07157 51397 7

Automatikhalter 1/4"

## 527



mm						Item No		EAN-Code
<b>2</b>	75	80	25	2,0	12	<b>527 202 40</b>	26	40 07157 22167 4
<b>2,5</b>	100	80	25	2,5	12	<b>527 253 40</b>	29	40 07157 22168 1
<b>3</b>	100	80	25	3,0	12	<b>527 303 40</b>	32	40 07157 22169 8
<b>4</b>	100	90	29	4,0	12	<b>527 403 40</b>	50	40 07157 22170 4
<b>5</b>	100	99	34	5,0	12	<b>527 503 40</b>	72	40 07157 22171 1
<b>6</b>	125	99	34	6,0	12	<b>527 604 40</b>	90	40 07157 22178 0
<b>8</b>	150	105	39	8,0	12	<b>527 805 40</b>	149	40 07157 22173 5

## 528



mm						Item No		EAN-Code
<b>4</b>	125	90	29		12	<b>528 040 40</b>	63	40 07157 22174 2
<b>5</b>	125	90	29		12	<b>528 050 40</b>	64	40 07157 22175 9
<b>5,5</b>	125	90	29		12	<b>528 055 40</b>	64	40 07157 22176 6
<b>5,5</b>	200	90	29		12	<b>528 058 40</b>	76	40 07157 50769 3
<b>6</b>	125	90	29		12	<b>528 060 40</b>	66	40 07157 22177 3
<b>6</b>	250	90	29		12	<b>528 068 40</b>	85	40 07157 22189 6
<b>7</b>	125	99	34		12	<b>528 070 40</b>	95	40 07157 22179 7
<b>7</b>	250	99	34		6	<b>528 078 40</b>	123	40 07157 22180 3
<b>8</b>	125	99	34		12	<b>528 080 40</b>	97	40 07157 22181 0
<b>9</b>	125	99	34		12	<b>528 090 40</b>	97	40 07157 22182 7
<b>10</b>	125	99	34		12	<b>528 100 40</b>	101	40 07157 22183 4
<b>11</b>	125	105	39		12	<b>528 110 40</b>	151	40 07157 22184 1
<b>12</b>	125	105	39		12	<b>528 120 40</b>	154	40 07157 22185 8
<b>13</b>	125	105	39		12	<b>528 130 40</b>	156	40 07157 22186 5
<b>14</b>	125	105	39		12	<b>528 140 40</b>	156	40 07157 22187 2

## 538



1/4"						Item No		EAN-Code
	100	99	34		6	<b>538 125 40</b>	102	40 07157 32348 4

## 597



				Item No		EAN-Code
90	29		12	<b>597 200 00</b>	55	40 07157 62403 1

Bottle Opener / Flaschenöffner



500



	Item No		EAN-Code
<b>Set 6-pcs. / Satz 6-tlg.</b>	<b>500 961 17</b>	570	40 07157 50174 5
(4 x) <b>500:</b>	3,5 x 100 / 4,0 x 100 / 5,5 x 125 / 6,5 x 150		
(2 x) <b>502:</b>	PH 1 x 80 / PH 2 x 100		

500



	Item No		EAN-Code
<b>Set 6-pcs. / Satz 6-tlg.</b>	<b>500 963 17</b>	590	40 07157 51311 3
(2 x) <b>500:</b>	4,0 x 100 / 6,5 x 150		
(2 x) <b>501:</b>	PZ 1 x 80 / PZ 2 x 100		
(2 x) <b>502:</b>	PH 1 x 80 / PH 2 x 100		

508



	Item No		EAN-Code
<b>Set 6-pcs. / Satz 6-tlg.</b>	<b>508 961 47</b>	642	40 07157 50178 3
(6 x) <b>508:</b>	Torx® 10 / Torx® 15 / Torx® 20 / Torx® 25 / Torx® 30 / Torx® 40		



508



	Item No		EAN-Code
<b>Set 7-pcs. / Satz 7-tlg.</b>	<b>508 971 47</b>	558	40 07157 50705 1
(7 x) <b>508:</b> Torx® 6 / Torx® 8 / Torx® 10 / Torx® 15 / Torx® 20 / Torx® 25 / Torx® 30			



500



	Item No		EAN-Code
<b>Set 7-pcs. / Satz 7-tlg.</b>	<b>500 971 37</b>	522	40 07157 51699 2
(3 x) <b>500:</b> 3,0 x 80 / 3,5 x 100 / 4,0 x 100			
(2 x) <b>502:</b> PH 1 x 80 / PH 2 x 100			
(2 x) <b>508:</b> Torx® 10 x 100 / Torx® 15 x 100			

 **felo**  
Innovations



500



	Item No		EAN-Code
<b>Set 3-pcs. / Satz 3-tlg.</b>	<b>500 933 34</b>	266	40 07157 51857 6
(1 x) <b>500:</b> 4,0 x 200			
(2 x) <b>502:</b> PH 1 x 80 / PH 2 x 200			

 **felo**  
Innovations

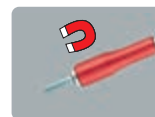

**508**



**felo**  
Innovations

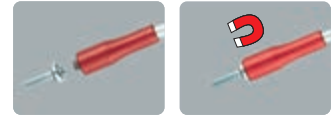

**Set 3-pcs. / Satz 3-tlg.**

[3 x] **508:** Torx® 10 / Torx® 15 / Torx® 20

**Item No**

**508 931 34**



204

**EAN-Code**

40 07157 51855 2

**500**



**Set 3-pcs. / Satz 3-tlg.**

[1 x] **500:** 4,0 x 300

[1 x] **501:** PZ 2 x 300

[1 x] **502:** PH 2 x 300

**Item No**

**500 931 14**



363

**EAN-Code**

40 07157 51775 3

**500**



**Set 3-pcs. / Satz 3-tlg.**

[2 x] **500:** 5,5 x 125 / 6,5 x 150

[1 x] **502:** PH 2 x 100

**Item No**

**500 934 14**



292

**EAN-Code**

40 07157 53707 2

**500**



**Set 5-pcs. / Satz 5-tlg.**

[3 x] **500:** 4,0 x 100 / 5,5 x 125 / 6,5 x 150

[2 x] **502:** PH 1 x 80 / PH 2 x 100

**Item No**

**500 951 18**



452

**EAN-Code**

40 07157 22062 2



500



	Item No		EAN-Code
<b>Set 7-pcs. / Satz 7-tlg.</b>	<b>500 971 18</b>	552	40 07157 22134 6
(4 x) <b>500:</b> 3,5 x 100 / 4,0 x 100 / 5,5 x 125 / 6,5 x 150			
(1 x) <b>501:</b> PZ 2 x 100			
(2 x) <b>502:</b> PH 1 x 80 / PH 2 x 100			



507



	Item No		EAN-Code
<b>Set 6-pcs. Torx® TR/ Satz 6-tlg.</b>	<b>507 961 48</b>	548	40 07157 50823 2
(6 x) <b>507:</b> Torx® TR 10 / Torx® TR 15 / Torx® TR 20 / Torx® TR 25 Torx® TR 30 / Torx® TR 40			



500



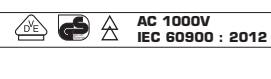

	Item No		EAN-Code
<b>Promo Pack 500 / 513 VDE</b> (440 mm / 325 mm / 305 mm)	<b>500 924 00</b>	10654	40 07157 51439 4
(16 x) <b>500 951 18</b>			
(3 x) <b>500:</b> 4,0 x 100 / 5,5 x 125 / 6,5 x 150			
(2 x) <b>502:</b> PH 1 x 80 / PH 2 x 100			
(8 x) <b>513 951 98</b>			
(4 x) <b>513:</b> 3,0 x 100 / 3,5 x 100 / 4,0 x 100 / 5,5 x 125			
(1 x) <b>515:</b> PZ 2 x 100			





500



	Item No		EAN-Code
<b>toolcase 12-pcs. / Koffer 12-tlg.</b>	<b>500 112 16</b>	1216	40 07157 22138 4
(5 x) <b>500:</b> 5,5 x 25 / 3,5 x 100 / 4,0 x 100 / 5,5 x 125 / 6,5 x 150			
(1 x) <b>550:</b> 8,0 x 155 			
(3 x) <b>501:</b> PZ 0 x 60 / PZ 1 x 80 / PZ 2 x 100			
(3 x) <b>502:</b> PH 0 x 60 / PH 1 x 80 / PH 2 x 100			



500



	Item No		EAN-Code
<b>toolcase 11-pcs. / Koffer 11-tlg.</b>	<b>500 111 16</b>	964	40 07157 32558 7
(4 x) <b>500:</b> 4,0 x 100 / 5,5 x 25 / 5,5 x 125 / 6,5 x 150			
(1 x) <b>501:</b> PZ 2 x 100			
(3 x) <b>502:</b> PH 1 x 80 / PH 2 x 25 / PH 2 x 100			
(2 x) <b>613:</b> 2,5 x 75 / 3,5 x 100    <b>AC 1000V</b> <b>IEC 60900 : 2012</b>			
(1 x) <b>361:</b> <b>Mains testing screwdriver / Spannungsprüfer</b> VDE 0680/6, 220-250 Volt			

**Mânere produse din polipropilena rezistentă la șocuri**

ütésálló polipropilén markolat



**Design ergonomic rafinat**

ergonomikus, kifinomult forma

**Capac de oțel**

acélkupak



**Cea mai puternică din seria 200**  
Legerősebb a 200-as sorozatból

## Serie 206

**Capac de oțel / acélkupak**

lamă cu lungime integrală / teljes hosszúságú penge

piuliță hexagonală / hatszögerősítés

lamă hexagonală / hatlapú penge



**piuliță hexagonală**

hatszögerősítés

**Lame hexagonale fabricate din oțel crom-molibden-vanadium**

a pengék anyaga  
króm-molibdén vanádium acél

**Design mâner anti-roll**

gurulásmentes markolat kialakítás



**Cod EAN pe fiecare produs**

EAN vonalkód minden terméken

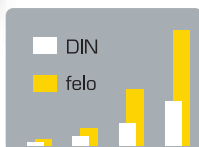

**Torsiune superioară ce depășește cerințele normelor DIN și ISO cu până la 100 %**

több mint 100 %-kal meghaladja az ISO és DIN szabványok követelményeit

**Lamă în lungime integrală**

teljes hosszúságú penge

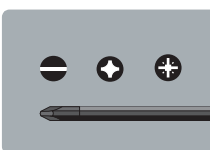
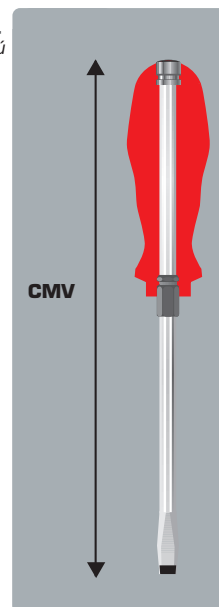

**Vârf negru pentru precizie**

bevonatmentes végződés a pontos illesztésért

## 206



									Item No		EAN-Code
<b>5,5 x 1,0</b>	100	98	34	5,0	12		<b>206 055 90</b>	94	40 07157 31690 5		
<b>6,5 x 1,2</b>	125	98	34	6,35	12		<b>206 065 90</b>	120	40 07157 24036 1		
<b>8,0 x 1,2</b>	150	105	38	8,0	6		<b>206 080 90</b>	195	40 07157 30876 4		
<b>10,0 x 1,6</b>	175	105	38	8,0	6		<b>206 100 90</b>	204	40 07157 13166 9		
<b>12,0 x 2,0</b>	200	105	38	10,0	6		<b>206 120 90</b>	286	40 07157 31692 9		

## 216



PZ							Item No		EAN-Code
<b>2</b>	100	98	34	6,35	12		<b>216 203 90</b>	115	40 07157 31694 3
<b>3</b>	150	105	38	8,0	6		<b>216 305 90</b>	195	40 07157 31696 7

## 226



PH							Item No		EAN-Code
<b>2</b>	100	98	34	6,35	12		<b>226 203 90</b>	115	40 07157 31698 1
<b>3</b>	150	105	38	8,0	6		<b>226 305 90</b>	194	40 07157 31700 1

## 206



	Item No		EAN-Code
<b>Set 5-pcs. / Satz 5-tlg.</b>	<b>206 951 98</b>	838	40 07157 31720 9
(3 x) <b>206:</b>	5,5 x 100 / 6,5 x 125 / 8,0 x 150		
(2 x) <b>226:</b>	PH 2 x 100 / PH 3 x 150		



**Mânere produse din polipropilena rezistentă la șocuri**

ütésálló polipropilén markolat



**Design ergonomic rafinat**

ergonomikus, kifinomult forma

## Calitate superioară și gamă variată Serie 200

Kiváló minőség és rendkívül széles választék

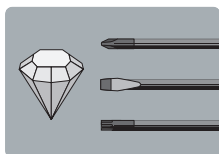

**Lame fabricate din oțel crom-molibden-vanadium**

ütésálló polipropilén markolat

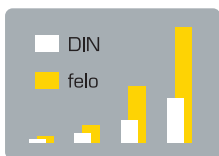

**Torsiune superioară ce depășește cerințele normelor DIN și ISO cu până la 100%**

több mint 100%-kal meghaladja az ISO és DIN szabványok követelményeit



**Design mâner anti-roll**

gurulásmentes markolat kialakítás



**Gaură de agățare pentru depozitarea facilă sau efect de levier**

furat a könnyebb tárolásért és erőkar alkalmazásáért



**Cod EAN pe fiecare produs**

EAN vonalkód minden terméken



**Vârf negru pentru precizie**

bevonatmentes végződés a pontos illesztésért

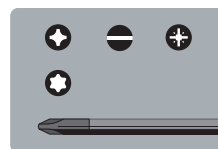



## 200



									Item No		EAN-Code
<b>2,5 x 0,4</b>	75	80	25	2,5	12		<b>200 022 90</b>	24	40 07157 13001 3		
<b>3,0 x 0,5</b>	80	80	25	3,0	12		<b>200 032 90</b>	26	40 07157 13003 7		
<b>3,5 x 0,6</b>	100	80	25	3,5	12		<b>200 353 90</b>	30	40 07157 13035 8		
<b>4,0 x 0,8</b>	100	90	29	4,0	12		<b>200 043 90</b>	43	40 07157 13010 5		
<b>5,0 x 0,8</b>	125	90	29	5,0	12		<b>200 054 90</b>	55	40 07157 13016 7		
<b>5,5 x 1,0</b>	125	98	34	5,0	12		<b>200 554 90</b>	68	40 07157 13041 9		
<b>6,5 x 1,2</b>	125	98	34	6,0	12		<b>200 654 90</b>	79	40 07157 16050 8		
<b>6,5 x 1,2</b>	150	98	34	6,0	12		<b>200 655 90</b>	85	40 07157 13051 8		
<b>8,0 x 1,2</b>	175	105	38	7,0	12		<b>200 086 90</b>	122	40 07157 13028 0		
<b>10,0 x 1,6</b>	200	105	38	8,0	6		<b>200 107 90</b>	151	40 07157 13032 7		

## 201



PZ							Item No		EAN-Code
<b>0</b>	60	80	25	3,0	12		<b>201 001 90</b>	25	40 07157 13076 1
<b>1</b>	80	90	29	4,5	12		<b>201 102 90</b>	44	40 07157 13081 5
<b>2</b>	100	98	34	6,0	12		<b>201 203 90</b>	75	40 07157 13084 6
<b>3</b>	150	105	38	8,0	6		<b>201 305 90</b>	134	40 07157 13089 1

## 202



PH							Item No		EAN-Code
<b>0</b>	60	80	25	3,0	12		<b>202 001 90</b>	24	40 07157 13099 0
<b>1</b>	80	90	29	4,5	12		<b>202 102 90</b>	44	40 07157 13106 5
<b>2</b>	100	98	34	6,0	12		<b>202 203 90</b>	75	40 07157 13111 9
<b>3</b>	150	105	38	8,0	6		<b>202 305 90</b>	131	40 07157 13117 1

## Stubby



							Item No		EAN-Code
<b>5,5 x 1,0</b>	25	58	33	5,0	12		<b>200 550 90</b>	30	40 07157 13037 2
<b>6,5 x 1,2</b>	25	58	33	6,0	12		<b>200 650 90</b>	34	40 07157 13045 7
<b>PZ 2</b>	25	58	33	6,0	12		<b>201 020 90</b>	34	40 07157 13079 2
<b>PH 2</b>	25	58	33	6,0	12		<b>202 020 90</b>	34	40 07157 13103 4

## 208



Torx®						Item No		EAN-Code
<b>6</b>	60	80	25	3,0	12	<b>208 061 90</b>	23	40 07157 31332 4
<b>7</b>	60	80	25	3,0	12	<b>208 071 90</b>	25	40 07157 31333 1
<b>8</b>	60	80	25	3,0	12	<b>208 083 90</b>	25	40 07157 31334 8
<b>9</b>	60	80	25	3,5	12	<b>208 093 90</b>	24	40 07157 31335 5
<b>10</b>	100	90	29	3,5	12	<b>208 103 90</b>	39	40 07157 31336 2
<b>15</b>	100	90	29	4,0	12	<b>208 153 90</b>	43	40 07157 31337 9
<b>20</b>	100	98	34	5,0	12	<b>208 203 90</b>	64	40 07157 31338 6
<b>25</b>	100	98	34	5,0	12	<b>208 253 90</b>	65	40 07157 31339 3
<b>27</b>	100	98	34	5,0	12	<b>208 273 90</b>	64	40 07157 31340 9
<b>30</b>	115	105	38	6,0	6	<b>208 303 90</b>	91	40 07157 31341 6
<b>40</b>	125	105	38	8,0	6	<b>208 404 90</b>	123	40 07157 31342 3

## 200



Set 5-pcs. / Satz 5-tlg.	Item No		EAN-Code
<b>Set 5-pcs. / Satz 5-tlg.</b>	<b>200 951 98</b>	374	40 07157 16052 2
(3 x ) <b>200:</b> 3,5 x 100 / 4,0 x 100 / 5,5 x 125			
(2 x ) <b>202:</b> PH 1 x 80 / PH 2 x 100			

## 200



Set 7-pcs. / Satz 7-tlg.	Item No		EAN-Code
<b>Set 7-pcs. / Satz 7-tlg.</b>	<b>200 972 98</b>	564	40 07157 16054 6
(5 x ) <b>200:</b> 3,5 x 100 / 4,0 x 100 / 5,5 x 125			
6,5 x 150 / 8,0 x 175			
(2 x ) <b>202:</b> PH 1 x 80 / PH 2 x 100			

200



Item No	Item No	Item No	EAN-Code
Set 7-pcs. / Satz 7-tlg.	200 973 98	554	40 07157 16055 3
[4 x] 200:	3,0 x 80 / 4,0 x 100 / 5,5 x 125 / 8,0 x 175		
[1 x] 201:	PZ 2 x 100		
[2 x] 202:	PH 1 x 80 / PH 2 x 100		



208





Item No	Item No	Item No	EAN-Code
Set 7-pcs. / Satz 7-tlg.	208 971 98	548	40 07157 50468 5
[7 x] 208:	Torx® 8 / Torx® 10 / Torx® 15 / Torx® 20 Torx® 25 / Torx® 30 / Torx® 40		



200





Item No	Item No	Item No	EAN-Code
Set 7-pcs. / Satz 7-tlg.	200 971 97	548	40 07157 50108 0
[3 x] 200:	4,0 x 0,8 / 5,5 x 1,0 / 6,5 x 1,2		
[2 x] 202:	PH 1 x 80 / PH 2 x 100		
[1 x] 613:	3,5 x 0,6    AC 1000V IEC 60900 : 2012		
[1 x] 361:	Mains testing screwdriver / Spannungsprüfer VDE 0680/6, 220-250 Volt		





200







	Item No		EAN-Code
<b>Set 7-pcs. / Satz 7-tlg.</b>	<b>200 972 97</b>	552	40 07157 50156 1
(3 x) <b>200:</b> 4,0 x 0,8 / 5,5 x 1,0 / 6,5 x 1,2			
(2 x) <b>201:</b> PZ 1 x 80 / PZ 2 x 100			
(1 x) <b>613:</b> 3,5 x 0,6    <b>AC 1000V</b> <b>IEC 60900 : 2012</b>			
(1 x) <b>361:</b> <b>Mains testing screwdriver / Spannungsprüfer</b> VDE 0680/6, 220-250 Volt			











200



	Item No		EAN-Code
<b>toolcase 12-pcs. / Koffer 12-tlg.</b>	<b>200 112 96</b>	1158	40 07157 22152 0
(4 x) <b>200:</b> 6,5 x 25 / 4,0 x 100 / 5,5 x 125 / 6,5 x 150			
(2 x) <b>201:</b> PZ 1 x 80 / PZ 2 x 100			
(3 x) <b>202:</b> PH 0 x 60 / PH 1 x 80 / PH 2 x 100			
(1 x) <b>206:</b> 8,0 x 150 			
(1 x) <b>613:</b> 3,5 x 100    <b>AC 1000V</b> <b>IEC 60900 : 2012</b>			
(1 x) <b>361:</b> <b>Mains testing screwdriver / Spannungsprüfer</b> VDE 0680/6, 220-250 Volt			

200



	Item No		EAN-Code
<b>toolcase 12-pcs. / Koffer 12-tlg.</b>	<b>200 114 96</b>	1163	40 07157 32506 8
(4 x) <b>200:</b> 4,0 x 100 / 5,5 x 25 / 5,5 x 125 / 6,5 x 150			
(1 x) <b>201:</b> PZ 2 x 100			
(1 x) <b>202:</b> PH 2 x 100			
(1 x) <b>206:</b> 8,0 x 150 			
(3 x) <b>613:</b> 2,5 x 75 / 3,5 x 100 / 4,0 x 100    <b>AC 1000V</b> <b>IEC 60900 : 2012</b>			
(1 x) <b>614:</b> PH 1 x 80    <b>AC 1000V</b> <b>IEC 60900 : 2012</b>			
(1 x) <b>361:</b> <b>Mains testing screwdriver / Spannungsprüfer</b> VDE 0680/6, 220-250 Volt			



**When every detail counts you don't make compromises.**

*Wenn es auf jedes Detail ankommt darf man keine Kompromisse machen.*

*J. Weigel*



**Capac de piele pentru a proteja împotriva aşchierii**  
bőrözött markolatvég a szállkásodás ellen

**Lamă în lungime integrală**  
teljes hosszúságú penge

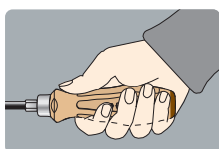
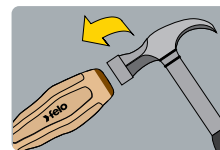

**Mâner ergonomic**  
ergonomikus markolat

**Mâner fabricat din lemn tare de fag**  
kemény bükkfa markolat

**Angajamentul nostru pentru  
sucele de mână tradiţionale  
Serie 330 de înalta calitate**

*A tradiţionalis  
szerszámok kedvelőinek*

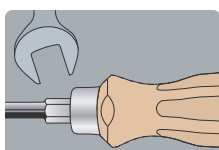

**Piuliţă hexagonală forjată**  
hatszögerősítés

**Design mâner anti-roll**  
gurulásmentes markolat kialakítás

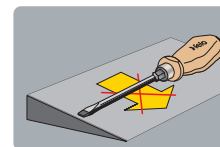

**Lame fabricate din oţel crom-molibden-vanadium**  
a pengék anyaga  
króm-molibdén-vanádium acél



**Lamă în lungime integrală**  
teljes hosszúságú penge

**Torsiune superioară ce depăşeşte cerinţele normelor DIN şi ISO cu până la 100%**  
több mint 100%-kal meghaladja az ISO és DIN szabványok követelményeit

**Cod EAN pe fiecare produs**  
EAN vonalkód minden terméken



**Lama cromată cu vârf negru pentru precizie**  
krómozott penge,  
bevonatmentes végződés

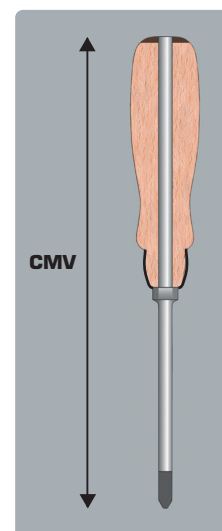

### 335

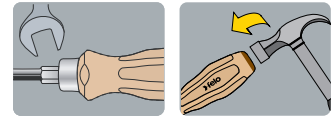
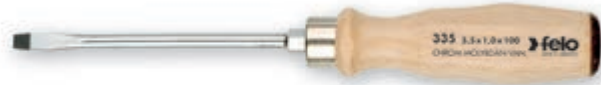

									Item No		EAN-Code
<b>3,5 x 0,6</b>	75	95	24	4,5	12				<b>335 035 90</b>	47	40 07157 18031 5
<b>4,5 x 0,8</b>	90	95	24	4,5	12				<b>335 045 90</b>	55	40 07157 18032 2
<b>5,5 x 1,0</b>	100	100	24	5,5	12				<b>335 055 90</b>	72	40 07157 18036 0
<b>7,0 x 1,2</b>	125	110	30	6,0	12				<b>335 065 90</b>	113	40 07157 18040 7
<b>9,0 x 1,2</b>	150	120	32	8,0	12				<b>335 080 90</b>	160	40 07157 18043 8
<b>10,0 x 1,6</b>	175	125	34	9,0	6				<b>335 100 90</b>	184	40 07157 18047 6
<b>12,0 x 2,0</b>	200	125	34	9,0	6				<b>335 120 90</b>	232	40 07157 18050 6

### 336

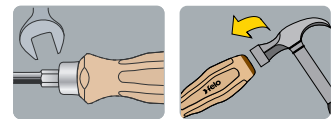

PZ							Item No		EAN-Code
<b>1</b>	80	95	24	4,5	12		<b>336 102 90</b>	47	40 07157 18060 5
<b>2</b>	100	110	30	6,0	12		<b>336 203 90</b>	88	40 07157 18061 2
<b>3</b>	150	120	32	8,0	6		<b>336 305 90</b>	163	40 07157 18062 9

### 337

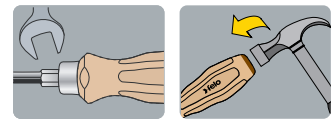

PH							Item No		EAN-Code
<b>1</b>	80	95	24	4,5	12		<b>337 102 90</b>	45	40 07157 18063 6
<b>2</b>	100	110	30	6,0	12		<b>337 203 90</b>	88	40 07157 18067 4
<b>3</b>	150	120	32	8,0	6		<b>337 305 90</b>	164	40 07157 18071 1

### 335

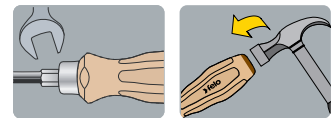

		Item No		EAN-Code
<b>Set 5-pcs. / Satz 5-tlg.</b>		<b>335 951 98</b>	592	40 07157 22155 1
(3 x) <b>335:</b>	5,5 x 100 / 7,0 x 125 / 9,0 x 150			
(2 x) <b>337:</b>	PH 1 x 80 / PH 2 x 100			

## 335

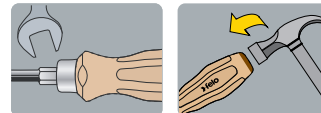

**Set 5-pcs. / Satz 5-tlg.**

[3 x] **335:** 5,5 x 100 / 7,0 x 125 / 9,0 x 150

[2 x] **336:** PZ 1 x 80 / PZ 2 x 100

**Item No**

**335 952 98**



592

**EAN-Code**

40 07157 30762 0

## 335

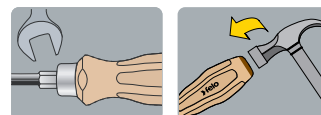

**Set 7-pcs. / Satz 7-tlg.**

[4 x] **335:** 4,5 x 90 / 5,5 x 100 / 7,0 x 125 / 9,0 x 150

[1 x] **336:** PZ 2 x 100

[2 x] **337:** PH 1 x 80 / PH 2 x 100

**Item No**

**335 971 98**



714

**EAN-Code**

40 07157 18108 4

## 057



**felo**  
Innovations



**XS 18 Classic 18-pcs. / Satz 18-tlg.**

[1 x] **Mini Ratchet 1/4" / Miniratsche 1/4"**

[7 x] **Sockets / Steckschlüsseleinsätze** 5 mm / 5,5 mm / 6 mm / 7 mm / 8 mm / 10 mm / 13 mm

[7 x] **Bits (C6,3 x 25 mm)**

4,5 x 0,6 / 5,5 x 0,8 / 6,5 x 1,2 / PZ 2 / PH 1 / PH 2 / PH 3

[1 x] **Extension / Verlängerung (50 mm) 1/4" - 1/4"**

[1 x] **Adapter / Adapter C 6,3 - 1/4" (25 mm) Bitholder / Bithalter E6,3 x 58 mm**

**Wooden Box / Holzbox 160 mm x 82 mm x 34 mm**

**Item No**

**057 718 66**



513

**EAN-Code**

40 07157 62367 6



# 490



**Awl / Rundahle**

60 60 32 4 12

**Item No**



**EAN-Code**

**490 041 10**

36

40 07157 31078 1

# 493



**Awl / Rundahle**

100 80 34 6 12

**Item No**



**EAN-Code**

**493 063 10**

72

40 07157 23006 5

# 498



**Reamer / Aufreiber**

100 80 34 6 12

**Item No**



**EAN-Code**

**498 063 10**

73

40 07157 23013 3

# 494



**Tacklifter / Reißzweckenheber**

100 80 34 12

**Item No**



**EAN-Code**

**494 003 30**

75

40 07157 24022 4

# 326



**Item No**



**EAN-Code**

**Reversible-Blade Screwdriver**

12

**326 965 10**

55

40 07157 31068 2

*Umsteckschraubendreher*

5,5 - PH 2 x 60 mm

**dto. in PP bag / in Beutel**

12

**326 965 11**

66

40 07157 18104 6

**Gaură de agățare pentru depozitarea facilă sau efect de levier**

*furat a könnyebb tárolásért és erőkar alkalmazásáért*

**Mânerul cu 30% mai subțire!**  
**30%-kal karcsúbb markolat**



**Simbolurile aferente șuruburilor imprimate pe mâner**  
*megkülönböztető jelek a markolaton*

**Mâner extralung extra hosszú markolat**



**ERGONIC® (pat.)**  
 U.S. Patent No 7,877,843  
**Eslim**

**Ergonic, singurul mâner care se adaptează mâinii utilizatorului!**

*Ergonic, az első markolat, amely alkalmazkodik a felhasználó tenyeréhez*

**AC 1000V  
 IEC 60900 : 2012**



**Design mâner anti-roll**

*gurulásmentes markolat kialakítás*

**Lame fabricate din oțel crom-molibden-vanadium**

*a pengék anyaga króm-molibdén vanádium acél*

**Izolația cu până la 50% mai subțire!**  
**50 %-kal karcsúbb szigetelés**



**Vârf negru pentru precizie**

*bevonatmentes végződés a pontos illesztésért*



Mănerul cu formă unică E-Slim este cu **30% mai subțire și 20% mai lung** și este potrivit ideal pentru a obține echilibrul perfect al torsiunii controlate, lungimii și a distanței de siguranță necesare pentru lucrul în spații înguste.

Az egyedülálló alakú E-Slim markolat 30%-kal vékonyabb és 20%-kal hosszabb, így tökéletesen ideális a szűk helyeken elhelyezkedő csavarok megfelelő nyomatékú rögzítéséhez vagy oldásához. A hosszabb markolat távolabb tartja kezét a munkaterülettől.

## Dezvoltat împreună cu electricienii!

Villanyszerelők tapasztalatai segítettek a fejlesztésben.

Toate șurubelnițele sunt certificate conform cu standardele DIN EN 60900 ce impun testarea individuală a fircărei lame la 10,000 de Volți pentru a putea garanta siguranța muncii până la 1,000 de Volți

Minden csavarhúzó 10000 Volton tesztelve a DIN EN 60900 szabványnak megfelelően, így akár 1000 V feszültség mellett is dolgozhat.



Șurubelnițele E-Slim au fost dezvoltate în cooperare cu electricienii pentru electricienii.

Izolația E-Slim este cu până la 50% mai subțire decât la șurubelnițele VDE convenționale, ajutând astfel la operarea șuruburilor îngropate.

Az E-Slim csavarhúzókat villanyszerelőkkel közösen fejlesztettük ki, az ő igényeik és tapasztalataik alapján, hogy a szigetelés ne akadályozza a mélyen fekvő csavarok elérését.



**felo**  
Innovations

## 413



AC 1000V  
IEC 60900 : 2012



								Item No		EAN-Code
<b>3,0 x 0,5</b>	100	105	25	3,5	12			<b>413 930 90</b>	45	40 07157 62631 8
<b>3,5 x 0,6</b>	100	105	25	3,5	12			<b>413 935 90</b>	45	40 07157 62635 6
<b>3,5 x 0,8</b>	100	105	25	3,5	12			<b>413 938 90</b>	45	40 07157 62637 0
<b>4,0 x 0,8</b>	100	105	25	4,0	12			<b>413 940 90</b>	46	40 07157 62639 4
<b>4,5 x 1,0</b>	125	115	27	4,5	12			<b>413 945 90</b>	62	40 07157 62641 7
<b>5,5 x 1,0</b>	125	115	27	5,5	12			<b>413 955 90</b>	73	40 07157 62643 1
<b>6,5 x 1,2</b>	125	115	27	6,5	12			<b>413 965 90</b>	86	40 07157 62645 5

## 414



AC 1000V  
IEC 60900 : 2012



PH							Item No		EAN-Code
<b>1</b>	80	105	25	4,5	12		<b>414 192 90</b>	45	40 07157 62647 9
<b>2</b>	100	115	27	6,0	12		<b>414 293 90</b>	73	40 07157 62649 3

## 415



AC 1000V  
IEC 60900 : 2012



PZ							Item No		EAN-Code
<b>1</b>	80	105	25	4,5	12		<b>415 192 90</b>	44	40 07157 62651 6
<b>2</b>	100	115	27	6,0	12		<b>415 293 90</b>	73	40 07157 62653 0

## 416



For terminal block screws

AC 1000V  
IEC 60900 : 2012



PlusMinus							Item No		EAN-Code
<b>H 1</b>	80	105	25	4,5	12		<b>416 192 90</b>	45	40 07157 62655 4
<b>H 2</b>	100	115	27	6,0	12		<b>416 293 90</b>	73	40 07157 62657 8

## 417



For terminal block screws

AC 1000V  
IEC 60900 : 2012



PlusMinus							Item No		EAN-Code
<b>Z 1</b>	80	105	25	4,5	12		<b>417 192 90</b>	45	40 07157 62659 2
<b>Z 2</b>	100	115	27	6,0	12		<b>417 293 90</b>	73	40 07157 62661 5

## 418



felo  
Innovations

AC 1000V  
IEC 60900 : 2012



Torx®						Item No		EAN-Code
<b>10</b>	100	105	25	3,5	12	<b>418 109 90</b>	46	40 07157 62663 9
<b>15</b>	100	105	25	3,5	12	<b>418 159 90</b>	46	40 07157 62665 3
<b>20</b>	125	115	27	4,5	12	<b>418 209 90</b>	62	40 07157 62667 7
<b>25</b>	125	115	27	4,5	12	<b>418 259 90</b>	63	40 07157 62669 1

## 419



felo  
Innovations

AC 1000V  
IEC 60900 : 2012



SQ						Item No		EAN-Code
<b>1</b> (1,75 mm)	100	105	25	4,5	12	<b>419 190 90</b>	46	40 07157 63167 1
<b>2</b> (2,30 mm)	125	115	27	4,5	12	<b>419 290 90</b>	62	40 07157 63169 5

## 413



felo  
Innovations

AC 1000V  
IEC 60900 : 2012



	Item No		EAN-Code
<b>E-slim set 4-pcs. VDE / E-SLIM Satz 4-tlg. VDE</b>	<b>413 841 98</b>	321	40 07157 62741 4
(2 x ) <b>413:</b> 3,5 x 100 / 5,5 x 125			
(2 x ) <b>414:</b> PH1 x 80 / PH2 x 100			

## 413



felo  
Innovations

AC 1000V  
IEC 60900 : 2012



	Item No		EAN-Code
<b>E-slim set 5-pcs. VDE / E-SLIM Satz 5-tlg. VDE</b>	<b>413 852 98</b>	359	40 07157 62853 4
(2 x ) <b>413:</b> 3,5 x 100 / 5,5 x 125			
(2 x ) <b>414:</b> PH 1 x 80 / PH 2 x 100			
<b>361:</b> Mains testing screwdriver VDE 0680/6, 220-250 Volt			



413

AC 1000V  
IEC 60900 : 2012

felo Innovations   



	Item No		EAN-Code
<b>E-slim set 5-pcs. VDE / E-SLIM Satz 5-tlg. VDE</b>	<b>413 851 98</b>	371	40 07157 62743 8
(3 x) <b>413:</b> 3,0 x 100 / 4,0 x 100 / 5,5 x 125			
(2 x) <b>414:</b> PH 1 x 80 / PH 2 x 100			



413

AC 1000V  
IEC 60900 : 2012

felo Innovations   



	Item No		EAN-Code
<b>E-slim toolcase 7-pcs. VDE / Koffer 6-tlg. VDE</b>	<b>413 807 36</b>	650	40 07157 62745 2
(3 x) <b>413:</b> 3,0 x 100 / 4,0 x 100 / 5,5 x 125			
(2 x) <b>414:</b> PH 1 x 80 / PH 2 x 100			
<b>415:</b> PZ 2 x 100			
<b>361:</b> Mains testing screwdriver VDE 0680/6, 220-250 Volt			



AC 1000V  
IEC 60900 : 2012



413



	Item No		EAN-Code
<b>E-slim XL-Rack 10-pcs. VDE / XL Rack 10-tlg. VDE</b>	<b>413 910 93</b>	1212	40 07157 63627 0
(4 x ) <b>413:</b>	3,0 x 100 / 3,5 x 100 / 4,0 x 100 / 5,5 x 125		
(2 x ) <b>414:</b>	PH 1 x 80 / PH 2 x 100		
(1 x ) <b>415:</b>	PZ 2 x 100		
(2 x ) <b>418:</b>	Torx® 15 x 100 / Torx® 20 x 125		
(1 x ) <b>361:</b>	<b>Mains testing screwdriver / Profi-Spannungsprüfer VDE 0680 150 V – 250 V</b>		
(1 x )	<b>Steel Rack / Werkzeughalter (Stahl)</b>		



Sets not included.  
Ohne Sätze

AC 1000V  
IEC 60900 : 2012



413



	Item No		EAN-Code
<b>E-slim Kombi Display 22 pcs. VDE / E-slim Kombi Display 22 tlg. VDE</b>	<b>413 881 90</b>	2471	40 07157 62749 0
(4 x 3) <b>413:</b>	3,0 x 100 / 3,5 x 100 / 4,0 x 100 / 5,5 x 125		
(2 x ) <b>413:</b>	6,5 x 125		
(2 x ) <b>414:</b>	PH 1 x 80		
(3 x ) <b>414:</b>	PH 2 x 100		
(3 x ) <b>415:</b>	PZ 2 x 100		

**Ergonic, primul mâner care se adaptează  
mâinii utilizatorului!**

Ergonic, az első markolat, amely alkalmazkodik a felhasználó tenyeréhez



**Mâner fin, fara  
îmbinări, pentru  
confort maxim**

sorjamentes végződés a maximális kényelemért

**Mâna și mânerul  
interacționează, fara efort**

marok és markolat között kisebb terhelés

**Mai puternic / Erősebb**

adaptabil / rugalmas

cu adevărat ergonomic / valóban ergonomikus

**Gaură de agățare pentru depozitarea  
facilă sau efect de levier**

furat a könnyebb tárolásért és erőkar alkalmazásáért

**Design mâner anti-roll**

gurulásmentes markolat kialakítás

**Simbolurile aferente șuruburilor  
imprimate pe mâner**

megkülönböztető jelek a markolaton



**Miez rezistent la impact cu  
lungime integrală**

ütésálló markolat váz



## VDE Serie 400 **ERGONIC**® (pat.)

AC 1000V  
IEC 60900 : 2012



**Lame fabricate  
din oțel  
crom-molibden-vanadium**

a pengék anyaga  
króm-molibdén vanádium acél

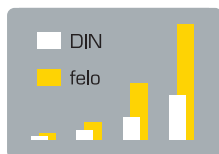

**Torsiune superioară  
ce depășește cerințele  
normelor DIN și ISO  
cu până la 100%**

több mint 100%-kal meghaladja az ISO és DIN szabványok követelményeit

**Cod EAN pe  
fiecare produs**

EAN vonalkód minden terméken



**Vârf negru  
pentru precizie**

bevonatmentes végződés a pontos illesztésért





AC 1000V  
IEC 60900 : 2012



### 413



								Item No		EAN-Code
<b>2,5 x 0,4</b>	75	86	25	2,5	12			<b>413 025 90</b>	28	40 07157 53133 9
<b>3,0 x 0,5</b>	100	86	25	3,0	12			<b>413 030 90</b>	32	40 07157 53135 3
<b>3,5 x 0,6</b>	100	86	25	3,5	12			<b>413 035 90</b>	34	40 07157 53139 1
<b>3,5 x 0,8</b>	100	86	25	3,5	12			<b>413 038 90</b>	34	40 07157 61731 6
<b>4,0 x 0,8</b>	100	94	30	3,5	12			<b>413 040 90</b>	46	40 07157 53141 4
<b>4,5 x 1,0</b>	125	101	33	4,5	12			<b>413 045 90</b>	69	40 07157 53143 8
<b>5,5 x 1,0</b>	125	101	33	4,5	12			<b>413 055 90</b>	68	40 07157 53145 2
<b>6,5 x 1,2</b>	150	106	36	5,5	6			<b>413 065 90</b>	100	40 07157 53147 6
<b>8,0 x 1,2</b>	175	112	39	7,0	6			<b>413 080 90</b>	140	40 07157 53149 0

AC 1000V  
IEC 60900 : 2012



### 414



PH							Item No		EAN-Code
<b>0</b>	60	86	25	3,0	12		<b>414 001 90</b>	29	40 07157 53151 3
<b>1</b>	80	94	30	5,0	12		<b>414 102 90</b>	51	40 07157 53153 7
<b>2</b>	100	106	36	6,0	12		<b>414 203 90</b>	94	40 07157 53155 1
<b>3</b>	150	112	39	8,0	6		<b>414 304 90</b>	150	40 07157 53157 5

AC 1000V  
IEC 60900 : 2012



### 415



PZ						Item No		EAN-Code
<b>1</b>	80	94	30	5,0	12	<b>415 102 90</b>	51	40 07157 53159 9
<b>2</b>	100	106	36	6,0	12	<b>415 203 90</b>	94	40 07157 53161 2
<b>3</b>	150	112	39	8,0	6	<b>415 304 90</b>	151	40 07157 53163 6

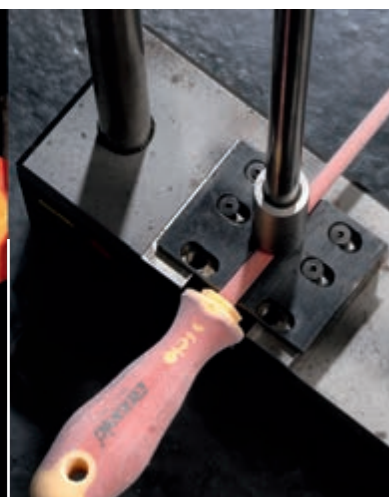
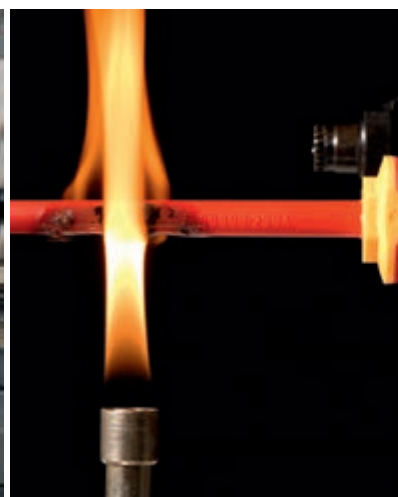
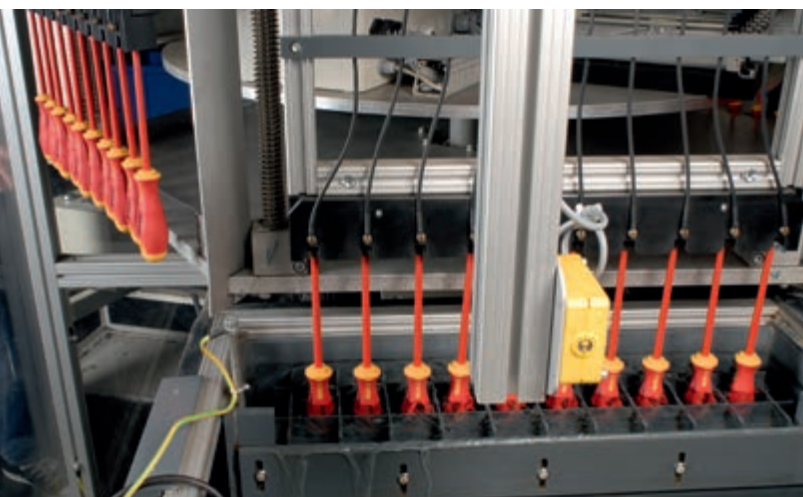

100 % testing (10.000 V)  
100 % getestet (10.000 V)

+ 5 additional tests on every material lot  
+ 5 weitere Tests bei jeder Materialcharge

## 416



AC 1000V  
IEC 60900 : 2012



Plus/Minus	↔		↔		↔	∅	📦	Item No	📦	EAN-Code
H1	80	94	30	5,0	12			<b>416 102 90</b>	51	40 07157 60311 1
H2	100	106	36	6,0	12			<b>416 203 90</b>	94	40 07157 60313 5

## 417



AC 1000V  
IEC 60900 : 2012



Plus/Minus	↔		↔		↔	∅	📦	Item No	📦	EAN-Code
Z1	80	94	30	5,0	12			<b>417 102 90</b>	51	40 07157 60315 9
Z2	100	106	36	6,0	12			<b>417 203 90</b>	94	40 07157 60317 3

## 417



AC 1000V  
IEC 60900 : 2012



Item No	📦	EAN-Code
<b>Set 2-pcs Plus/Minus VDE / Satz 2-tlg.</b>	290	40 07157 63697 3

{ 2 x } 417: Z1 / Z2

## 418



Torx®	↔		↔		↔	∅	📦	Item No	📦	EAN-Code
10	100	86	25	3,5	12			<b>418 103 90</b>	37	40 07157 60369 2
15	100	94	30	3,5	12			<b>418 153 90</b>	54	40 07157 60371 5
20	125	101	33	4,5	12			<b>418 203 90</b>	76	40 07157 60373 9
25	125	106	36	4,5	12			<b>418 253 90</b>	84	40 07157 60375 3
30	150	112	39	6,0	6			<b>418 303 90</b>	118	40 07157 60377 7

## 419



SQ	↔		↔		↔	∅	📦	Item No	📦	EAN-Code
1 (1,75 mm)	100	94	30	3,5	12			<b>419 100 90</b>	47	40 07157 57343 8
2 (2,30 mm)	100	106	36	6,0	12			<b>419 200 90</b>	94	40 07157 57345 2



**felo**  
Innovations

AC 1000V  
IEC 60900 : 2012



**413**



**Set 3-pcs. VDE / Satz 3-tlg. VDE**

Item No



EAN-Code

**413 931 94**

254

40 07157 53175 9

(2 x) **413:** 4,0 x 100 / 5,5 x 125

(1 x) **414:** PH 2 x 100



**felo**  
Innovations

AC 1000V  
IEC 60900 : 2012



**413**



**Set 6-pcs. VDE / Satz 6-tlg. VDE**

Item No



EAN-Code

**413 961 98**

506

40 07157 53169 8

(4 x) **413:** 3,0 x 100 / 4,0 x 100 / 5,5 x 125 / 6,5 x 150

(2 x) **414:** PH 1 x 80 / PH 2 x 100



**felo**  
Innovations

AC 1000V  
IEC 60900 : 2012



**413**



**Set 6-pcs. VDE / Satz 6-tlg.**

Item No



EAN-Code

**413 963 98**

413

40 07157 61081 2

(3 x) **413:** 2,5 x 75 / 4,0 x 100 / 5,5 x 125

(2 x) **414:** PH 1 x 80 / PH 2 x 100

(1 x) **361:** **Mains testing screwdriver / Spannungsprüfer** VDE 0680/6, 220-250 Volt



413



	Item No		EAN-Code
<b>toolcase 6-pcs. VDE / Koffer 6-tlg.</b>	<b>413 106 36</b>	629	40 07157 64413 8
(4 x) <b>413:</b>	3,0 x 100 / 4,0 x 100 / 5,5 x 125		
(2 x) <b>414:</b>	PH 1 x 80 / PH 2 x 100		
(2 x) <b>415:</b>	PZ 2 x 100		

AC 1000V  
IEC 60900 : 2012



413



	Item No		EAN-Code
<b>Ergonic XL-Rack 10-pcs. VDE / XL Rack 10-tlg. VDE</b>	<b>414 910 93</b>	1224	40 07157 63631 7
(4 x) <b>413:</b>	2,5 x 75 / 3,5 x 100 / 4,0 x 100 / 5,5 x 125		
(3 x) <b>414:</b>	PH 0 x 60 / PH 1 x 80 / PH 2 x 100		
(1 x) <b>415:</b>	PZ 2 x 100		
(2 x) <b>418:</b>	Torx® 10 x 100 / Torx® 20 x 125		
(1 x)	<b>Steel Rack / Werkzeughalter (Stahl)</b>		

AC 1000V  
IEC 60900 : 2012



# M-TEC

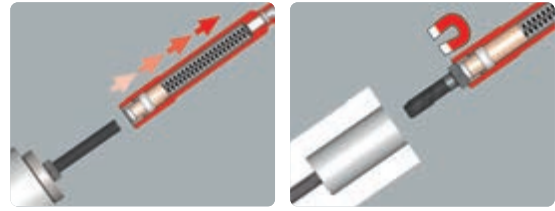

AC 1000V  
IEC 60900 : 2012



419



MTEc					Item No		EAN-Code
5,5	110	94	30	12	419 055 30	103	40 07157 60297 8
6	110	94	30	12	419 060 30	104	40 07157 60351 7
7	110	94	30	12	419 070 30	114	40 07157 60299 2
8	110	101	33	12	419 080 30	133	40 07157 60301 2
10	125	101	33	12	419 100 30	140	40 07157 60303 6
13	125	106	36	12	419 130 30	237	40 07157 60305 0



# M-TEC

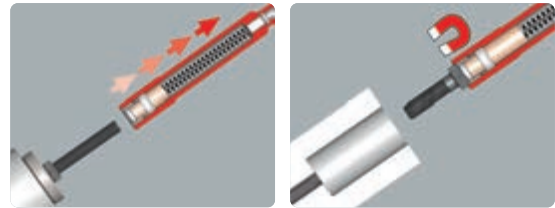

AC 1000V  
IEC 60900 : 2012



419



	Item No		EAN-Code
toolcase 6-pcs. M-Tec VDE / Koffer 6-tlg. M-Tec VDE	419 106 36	980	40 07157 61371 4
(6 x ) 419:	5,5 x 110 / 6,0 x 110 / 7,0 x 110 / 8,0 x 110		
	10,0 x 125 / 13,0 x 125		

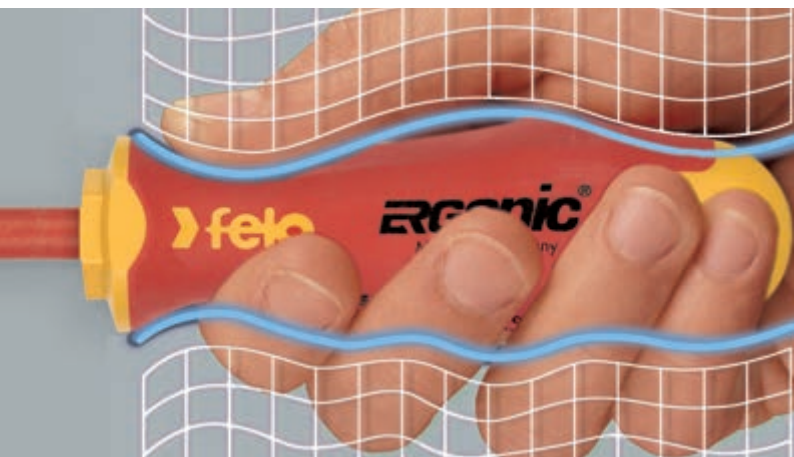

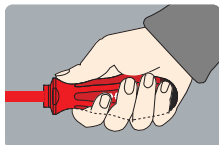

**Material exterior soft-grip plăcut pentru torsiune maximă**

*kellemes tapintású markolat a legnagyobb nyomaték átvitelével*

**Mâner fin, fără îmbinări, pentru confort maxim**

*sorjamentes végződés a maximális kényelemért*

## Originalul / Az eredeti VDE Serie 500

**Leaderii in designul mânerului /**  
A korszakalkotó markolatforma  
**calitatea lamei / minőségi penge**  
**tehnologia bi-component /**  
kétkomponenses technológia

**AC 1000V  
IEC 60900 : 2012**



**Lame fabricate din oțel crom-molybden-vanadium**

*a pengék anyaga króm-molibdén vanádium acél*

**Design ergonomic rafinat**

*ergonomikus, kifinomult forma*

**Torsiune superioară ce depășește cerințele normelor DIN și ISO cu până la 100%**

*több mint 100%-kal meghaladja az ISO és DIN szabványok követelményeit*

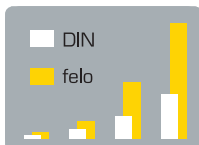

**Design mâner anti-roll**

*gurulásmentes markolat kialakítás*

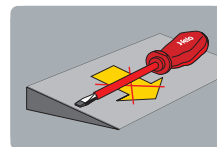

**Gaură de agățare pentru depozitarea facilă sau efect de levier**

*furat a könnyebb tárolásért és erőkar alkalmazásáért*

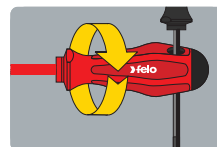
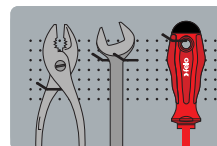

**Cod EAN pe fiecare produs**

*EAN vonalkód minden terméken*



**Vârf negru pentru precizie**

*bevonatmentes végződés a pontos illesztésért*



## 513



AC 1000V  
IEC 60900 : 2012

				Item No		EAN-Code		
	75	68	20	2,5	12	<b>513 025 90</b>	16	40 07157 22141 4
	100	68	20	3,0	12	<b>513 030 90</b>	20	40 07157 22113 1
	100	80	25	3,5	12	<b>513 035 90</b>	34	40 07157 22114 8
	100	80	25	3,5	12	<b>513 040 90</b>	34	40 07157 22115 5
	125	99	34	4,5	12	<b>513 045 90</b>	77	40 07157 50124 0
	125	99	34	4,5	12	<b>513 055 90</b>	72	40 07157 22116 2
	150	99	34	5,5	6	<b>513 065 90</b>	89	40 07157 22117 9
	175	105	39	7,0	6	<b>513 080 90</b>	136	40 07157 22118 6

## 514



AC 1000V  
IEC 60900 : 2012

PH				Item No		EAN-Code		
<b>0</b>	60	80	25	3,0	12	<b>514 001 90</b>	28	40 07157 22142 1
<b>1</b>	80	90	29	4,5	12	<b>514 102 90</b>	49	40 07157 22119 3
<b>2</b>	100	99	34	6,0	12	<b>514 203 90</b>	83	40 07157 22120 9
<b>3</b>	150	105	39	8,0	6	<b>514 304 90</b>	145	40 07157 22143 8

## 515



AC 1000V  
IEC 60900 : 2012

PZ				Item No		EAN-Code		
<b>1</b>	80	90	29	4,5	12	<b>515 102 90</b>	49	40 07157 22121 6
<b>2</b>	100	99	34	6,0	12	<b>515 203 90</b>	83	40 07157 22122 3
<b>3</b>	150	105	39	8,0	6	<b>515 304 90</b>	147	40 07157 22144 5

## 518



Bitholder			Item No		EAN-Code		
<b>1/4"</b>	105	99	34	6	<b>518 125 90</b>	107	40 07157 50785 3

1/4"



**020**



Item No



EAN-Code

**E-Pro 11+1-pcs. / E-Pro 11+1-tlg.**

6

**020 912 06**

220

40 07157 51427 1

(1 x) **518:** 1/4" x 105

(4 x) **020:** 3,0 x 0,5 / 4,0 x 0,8 / 5,5 x 1,0 / 7,0 x 1,2

(2 x) **021:** PZ 1 / PZ 2

(3 x) **022:** PH 0 / PH 1 / PH 2

(2 x) **026:** Torx® 20 / Torx® 15



**513**



**AC 1000V**  
**IEC 60900 : 2012**

Item No



EAN-Code

**Set 6-pcs. / Satz 6-tlg.**

**513 961 97**

490

40 07157 50176 9

(4 x) **513:** 3,0 x 100 / 3,5 x 100 / 4,0 x 100 / 5,5 x 125

(2 x) **514:** PH 1 x 80 / PH 2 x 100



**513**



**AC 1000V**  
**IEC 60900 : 2012**

Item No



EAN-Code

**Set 6-pcs. / Satz 6-tlg.**

**513 961 98**

487

40 07157 50120 2

(3 x) **513:** 3,5 x 100 / 4,0 x 100 / 5,5 x 125

(2 x) **514:** PH 1 x 80 / PH 2 x 100

(1 x) **361:** **Mains testing screwdriver / Spannungsprüfer**

VDE 0680/6, 220-250 Volt



**513**



**AC 1000V  
IEC 60900 : 2012**



**Set 5-pcs. / Satz 5-tlg.**

(4 x) **513:** 3,0 x 100 / 3,5 x 100 / 4,0 x 100 / 5,5 x 125

(1 x) **515:** PZ 2 x 100

**Item No**

**513 951 98**



360

**EAN-Code**

40 07157 22136 0

**513**



**AC 1000V  
IEC 60900 : 2012**



**Set 5-pcs. / Satz 5-tlg.**

(3 x) **513:** 2,5 x 75 / 3,0 x 100 / 4,0 x 100

(2 x) **514:** PH 1 x 80 / PH 2 x 100

**Item No**

**513 956 98**



400

**EAN-Code**

40 07157 32074 2

**513**



**AC 1000V  
IEC 60900 : 2012**



**Set 3-pcs. / Satz 3-tlg.**

(2 x) **513:** 4,0 x 100 / 5,5 x 125

(1 x) **514:** PH 2 x 100

**Item No**

**513 931 14**



236

**EAN-Code**

40 07157 52235 1

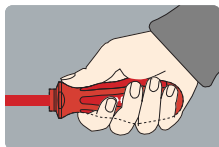

### Design ergonomic rafinat

ergonómikus, kifinomult forma  
ütésálló polipropilén markolat

AC 1000V  
IEC 60900 : 2012



**Calitate superioară și gamă  
variată**

**VDE Serie 600**

*Kiváló minőség és  
rendkívül széles választék*

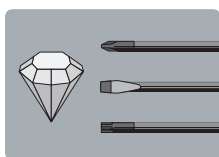

### Lame fabricate din oțel crom-molibden-vanadium

a pengék anyaga króm-molibdén  
vanádium acél

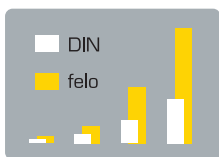

### Torsiune superioară ce depășește cerințele normelor DIN și ISO cu până la 100%

több mint 100%-kal  
meghaladja az ISO és DIN  
szabványok követelményeit



### Design mâner anti-roll

gurulásmentes markolat  
kialakítás

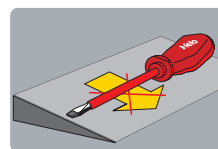

### Gaură de agățare pentru depozita- rea facilă sau efect de levier

furat a könnyebb tárolásért és  
erőkar alkalmazásáért

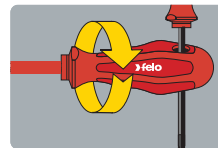
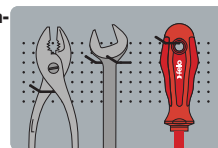

### Cod EAN pe fiecare produs

EAN vonalkód minden terméken



### Vârf negru pentru precizie

bevonatmentes végződés a  
pontos illesztésért

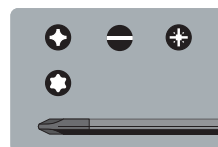



AC 1000V  
IEC 60900 : 2012

## 613



									Item No		EAN-Code
<b>2,5 x 0,4</b>	75	75	23	2,5	12	<b>613 025 90</b>	20	40 07157 10134 1			
<b>3,0 x 0,5</b>	100	75	23	3,0	12	<b>613 030 90</b>	24	40 07157 10137 2			
<b>3,5 x 0,6</b>	100	80	25	3,5	12	<b>613 035 90</b>	30	40 07157 10139 6			
<b>4,0 x 0,8</b>	100	90	29	3,5	12	<b>613 040 90</b>	40	40 07157 10141 9			
<b>5,5 x 1,0</b>	125	99	34	4,5	12	<b>613 055 90</b>	64	40 07157 10143 3			
<b>6,5 x 1,2</b>	150	99	34	5,5	6	<b>613 065 90</b>	81	40 07157 10146 4			
<b>8,0 x 1,2</b>	175	105	39	7,0	6	<b>613 080 90</b>	126	40 07157 10147 1			
<b>8,0 x 1,6</b>	200	105	39	7,0	6	<b>613 090 90</b>	136	40 07157 10148 8			
<b>10,0 x 1,6</b>	200	115	42	8,0	6	<b>613 100 90</b>	182	40 07157 10149 5			



AC 1000V  
IEC 60900 : 2012

## 614



PH						Item No		EAN-Code
<b>0</b>	60	80	25	3,0	12	<b>614 001 90</b>	21	40 07157 24001 9
<b>1</b>	80	90	29	5,0	12	<b>614 102 90</b>	44	40 07157 10150 1
<b>2</b>	100	99	34	6,0	12	<b>614 203 90</b>	75	40 07157 10153 2
<b>3</b>	150	105	39	8,0	6	<b>614 304 90</b>	135	40 07157 10156 3



AC 1000V  
IEC 60900 : 2012

## 615



PZ						Item No		EAN-Code
<b>0</b>	60	80	25	3,0	12	<b>615 001 90</b>	21	40 07157 24008 8
<b>1</b>	80	90	29	5,0	12	<b>615 102 90</b>	44	40 07157 24009 5
<b>2</b>	100	99	34	6,0	12	<b>615 203 90</b>	75	40 07157 24010 1
<b>3</b>	150	105	39	8,0	6	<b>615 304 90</b>	138	40 07157 24011 8



AC 1000V  
IEC 60900 : 2012

## 613



	Item No		EAN-Code
<b>Set 7-pcs. / Satz 7-tlg.</b>	<b>613 973 97</b>	504	40 07157 51401 1
(5 x) <b>613:</b> 2,5 x 75 / 3,0 x 100 / 3,5 x 100 / 4,0 x 100 / 5,5 x 125			
(2 x) <b>614:</b> PH 1 x 80 / PH 2 x 100			



AC 1000V  
IEC 60900 : 2012

## 613



	Item No		EAN-Code
<b>Set 7-pcs. / Satz 7-tlg.</b>	<b>613 974 97</b>	558	40 07157 51403 5
(3 x) <b>613:</b> 2,5 x 75 / 4,0 x 100 / 5,5 x 125			
(2 x) <b>614:</b> PH 1 x 80 / PH 2 x 100			
(2 x) <b>615:</b> PZ 1 x 80 / PZ 2 x 100			



AC 1000V  
IEC 60900 : 2012

613



	Item No		EAN-Code
<b>Set 6-pcs / Satz 6-tlg</b>	<b>613 962 98</b>	362	40 07157 51405 9
(3 x) <b>613:</b>	2,5 x 75 / 4,0 x 100 / 5,5 x 125		
(2 x) <b>614:</b>	PH 1 x 80 / PH 2 x 100		
(1 x) <b>361:</b>	<b>Mains testing screwdriver / Spannungsprüfer</b> VDE 0680/6, 220-250 Volt		



AC 1000V  
IEC 60900 : 2012

613



	Item No		EAN-Code
<b>Set 10-pcs / IEC Koffer 10-tlg.</b>	<b>600 110 96</b>	912	40 07157 10021 4
(7 x) <b>613:</b>	2,5 x 75 / 3,0 x 100 / 3,5 x 100 / 4,0 x 100 5,5 x 125 / 6,5 x 150 / 8,0 x 175		
(2 x) <b>614:</b>	PH 1 x 80 / PH 2 x 100		
(1 x) <b>361:</b>	<b>Mains testing screwdriver / Spannungsprüfer</b> VDE 0680/6, 220-250 Volt		

**12 șurubelnițe IEC interschimbabile**  
**Lame cu mâner bi-component într-o cutie**  
**rezistentă & Smart**

*12 cserélhető szigetelt csavarhúzópenge*  
*kétkomponensű markolattal -*  
*erős, ütészálló dobozban*

**Fiecare șurubelniță testată individual la**  
**10.000 de Volți, în conformitate cu**  
**standardul DIN ISO 60900**

*minden csavarhúzó egyedileg*  
*10.000 Volton tesztelve, teljesen megfelel*  
*a DIN ISO 60900 szabványnak*

**AC 1000V**  
**IEC 60900 : 2012**



**Lamele se potrivesc perfect, sistem quick**  
**release pe mâner, împotriva extracției**  
**nedorite a lamei**

*biztos pengerögztetés, gyorskioldó*  
*gomb a markolaton, véletlen kiesés*  
*ellen védve*



**Prima sculă compactă**  
**inteligentă pentru electricieni**

**Esmart (pat.)**

*Az első*  
*átalakítható*  
*szigetelt*  
*szerszám*





**12 lame interscimbabile pot fi combinate cu ușurință cu un mâner bi-component. Un închizător automat reține lamele în siguranță în mâner și previne scoaterea lor fără intenție. Pentru mai multă siguranță!**

*12 cserélhető szigetelt csavarhúzópenge kétkomponensű markolattal - erős, ütészálló dobozban. Biztos pengérögztítés, gyorskioldó gomb a markolaton, véletlen kiesés ellen védve.*

## Primul set de scule compact pentru electricieni.

*Az első átalakítható szigetelt szerszám*

**E-SMART nu face nici un compromis. Toate șurubelnițele sunt certificate și fiecare lamă este testată la 10,000 de Volți pentru lucrul cu pâna la 1,000 de Volți.**

*Az E-SMART szerszámokkal sem kell kompromisszumot kötnie. Minden csavarhúzó 10000 Volton tesztelve a DIN EN 60900 szabványnak megfelelően, így akár 1000 V feszültség mellett is dolgozhat.*



**Folosite împreună cu căpăcelul atașabil de precizie, fiecare lama poate fi transformată într-o șurubelniță fină de precizie ce poate aplica forță măsurată pentru piese de lucru sensibile.**

*Precíziós kupak és puha markolat rész alkalmassá teszi a kis nyomatókat követelő alkalmazásokhoz is.*



**felo**  
Innovations



AC 1000V  
IEC 60900 : 2012



felo  
Innovations



## 063



	Item No		EAN-Code
<b>Felo E-SMART Box 14-pcs. / Box 14-tlg.</b> (12 x )	<b>063 913 06</b>	984	40 07157 51719 7
<b>Blade / Klinge</b>	2,5 x 0,4 / 3,0 x 0,5 / 3,5 x 0,6 / 4,0 x 0,8 / 5,5 x 1,0 / 6,5 x 1,2		
	PZ 2		
	PH 1 / PH 2		
	Torx® 10 / Torx® 15 / Torx® 20		
<b>Handle / Griff</b> 95 x 32 mm			
<b>Precision Cap / Drehkappe</b>			
<b>StrongBox</b> 230 x 130 x 56 mm			



AC 1000V  
IEC 60900 : 2012



felo  
Innovations



## 063



	Item No		EAN-Code
<b>Felo E-SMART Box in Blister Box 14-pcs. / Box 14-tlg.</b> (12 x )	<b>063 913 01</b>	1044	40 07157 53077 6
<b>Blade / Klinge</b>	2,5 x 0,4 / 3,0 x 0,5 / 3,5 x 0,6 / 4,0 x 0,8 / 5,5 x 1,0 / 6,5 x 1,2		
	PZ 2		
	PH 1 / PH 2		
	Torx® 10 / Torx® 15 / Torx® 20		
<b>Handle / Griff</b> 95 x 32 mm			
<b>Precision Cap / Drehkappe</b>			
<b>StrongBox</b> 230 x 130 x 56 mm			





AC 1000V  
IEC 60900 : 2012



felo  
Innovations







063



	Item No		EAN-Code
<b>Felo E-SMART Industry Box 14-pcs. / Box 14-tlg.</b> (10 x) <b>Blade / Klinge</b>	<b>063 913 16</b>	1071	40 07157 53263 3
2,5 x 0,4 / 3,0 x 0,5 / 3,5 x 0,6 / 4,0 x 0,8 / 5,5 x 1,0 / 6,5 x 1,2			
PZ 2			
PH 1 / 2			
Z 2			
Bit: Spanner 10 x 25			
<b>Universal Cabinet key / Schaltschrankschlüssel</b>			
<b>Handle / Griff 95 x 32 mm</b>			
<b>Precision Cap / Drehkappe</b>			
<b>StrongBox 230 x 130 x 56 mm</b>			

063



-  (1 x) Spanner 10
-  (3 x) 5 mm, 6, 7
-  (1 x) 9 mm
-  (1 x) 3 - 5 mm
-  (1 x) 1/4"

	Item No		EAN-Code
<b>Universal Cabinet Key (in Blister) / Schaltschrankschlüssel (auf Karte)</b>	<b>063 999 01</b>	157	40 07157 62417 8





AC 1000V  
IEC 60900 : 2012



felo  
Innovations



063



	Item No		EAN-Code
<b>Zip-Bag 19-pcs. / Reissverschlussstasche 19-tlg.</b> (14 x) <b>Blade / Klinge</b>	<b>063 919 04</b>	1550	40 07157 60353 1
2,5 x 0,4 / 3,0 x 0,5 / 3,5 x 0,6 / 4,0 x 0,8 / 5,5 x 1,0 / 6,5 x 1,2			
PZ 2			
PH 1 / 2			
Torx® 10 / Torx® 15 / Torx® 20			
H 2			
Z 2			
<b>Handle / Griff 95 x 32 mm</b>			
<b>Precision Cap / Drehkappe</b>			
<b>Combination Pliers / Kombizange 180 mm</b>			
<b>Diagonal Nippers / Seitenschneider 160 mm</b>			
<b>Mains testing Screwdriver / Spannungsprüfer 3,0 mm x 70 mm</b> (VDE 0680/6, 150-250 Volt)			
<b>Nylon bag / Nylon Tasche 310 x 190 x 70 mm</b>			

## Lame slim VDE pentru Seria Nm

Testate individual conform EN 60900:2012

Szigetelt pengék nyomaték csavarhúzóinkhoz

Egyenként tesztelve az EN 60900:2012 szerint

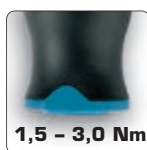
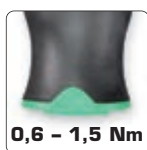

Insulation up to  
50 % slimmer!

Isolierung bis zu  
50 % schlanker!



AC 1000V  
IEC 60900 : 2012



108



Nm VDE slim		Nm max			Item No		EAN-Code
<b>3,5 x 0,6</b>	170		1/4"	1	<b>100 353 94</b>	23	40 07157 63865 6
<b>4,0 x 0,8</b>	170		1/4"	1	<b>100 043 94</b>	24	40 07157 63863 2
<b>5,5 x 1,0</b>	170		1/4"	1	<b>100 554 94</b>	26	40 07157 63867 0
<b>PH 1</b>	170		1/4"	1	<b>102 102 94</b>	26	40 07157 63873 1
<b>PH 2</b>	170		1/4"	1	<b>102 203 94</b>	31	40 07157 63875 5
<b>PZ 1</b>	170		1/4"	1	<b>101 102 94</b>	26	40 07157 63869 4
<b>PZ 2</b>	170		1/4"	1	<b>101 203 94</b>	31	40 07157 63871 7
<b>H2 +/-</b>	170		1/4"	1	<b>106 203 94</b>	31	40 07157 63877 9
<b>Z1 +/-</b>	170		1/4"	1	<b>107 102 94</b>	31	40 07157 63879 3
<b>Z2 +/-</b>	170		1/4"	1	<b>107 203 94</b>	31	40 07157 63881 6



felo  
Innovations

AC 1000V  
IEC 60900 : 2012



063

				Item No		EAN-Code
⊖	<b>2,5 x 0,4</b>	75 mm	1	<b>063 025 04</b>	30	40 07157 51721 0
	<b>3,0 x 0,5</b>	100 mm	1	<b>063 030 04</b>	34	40 07157 51723 4
	<b>3,5 x 0,6</b>	100 mm	1	<b>063 035 04</b>	37	40 07157 51725 8
	<b>4,0 x 0,8</b>	100 mm	1	<b>063 040 04</b>	37	40 07157 51727 2
	<b>5,5 x 1,0</b>	100 mm	1	<b>063 055 04</b>	45	40 07157 51729 6
	<b>6,5 x 1,2</b>	100 mm	1	<b>063 065 04</b>	53	40 07157 51731 9
⊕	<b>PH 1</b>	80 mm	1	<b>063 102 04</b>	48	40 07157 51733 3
	<b>PH 2</b>	100 mm	1	<b>063 203 04</b>	57	40 07157 51735 7
⊕	<b>PZ 1</b>	80 mm	1	<b>063 102 14</b>	41	40 07157 51737 1
	<b>PZ 2</b>	100 mm	1	<b>063 203 14</b>	57	40 07157 51739 5
⊕	<b>Torx® 8</b>	100 mm	1	<b>063 083 04</b>	35	40 07157 51741 8
	<b>Torx® 10</b>	100 mm	1	<b>063 103 04</b>	37	40 07157 51743 2
	<b>Torx® 15</b>	100 mm	1	<b>063 153 04</b>	37	40 07157 51745 6
	<b>Torx® 20</b>	100 mm	1	<b>063 203 24</b>	41	40 07157 51747 0
⊕	<b>H 1</b>	80 mm	1	<b>063 112 04</b>	48	40 07157 51887 3
	<b>H 2</b>	100 mm	1	<b>063 223 04</b>	57	40 07157 51889 7
⊕	<b>Z 1</b>	80 mm	1	<b>063 112 14</b>	41	40 07157 51891 0
	<b>Z 2</b>	100 mm	1	<b>063 223 14</b>	57	40 07157 51893 4
□	<b>SQ0</b> (1,75 mm)	100 mm	1	<b>063 000 04</b>	34	40 07157 53089 9
	<b>SQ1</b> (2,30 mm)	100 mm	1	<b>063 100 04</b>	37	40 07157 53091 2
	<b>SQ2</b> (2,80 mm)	100 mm	1	<b>063 200 04</b>	57	40 07157 53093 6
	<b>SQ3</b> (3,30 mm)	100 mm	1	<b>063 300 04</b>	57	40 07157 53095 0

063



	Item No		EAN-Code
Handle / Griff	<b>063 105 00</b>	42	40 07157 51749 4

## Şurubelniță tester VDE / Szigetelt fázisceruza



361



Item No



EAN-Code

**Mains testing screwdriver / Profi-Spannungsprüfer VDE 0680 150 V – 250 V**

**3,0 x 0,8** 70 mm 23 mm 12 **361 400 00** 30 40 07157 52701 1



361



Item No



EAN-Code

**Mains testing screwdriver / Profi-Spannungsprüfer VDE 0680 150 V – 250 V in Blister / auf Karte**

**3,0 x 0,8** 70 mm 23 mm 12 **361 400 01** 43 40 07157 53229 9

**Safety tools without compromises. Designed and made in Germany.**

*Sicherheitswerkzeuge ohne Kompromisse. Konstruiert und hergestellt in Deutschland.*



361



Item No



EAN-Code

**Mains testing screwdriver / Spannungsprüfer** VDE 0680 220 V - 250 V

**3,0 x 0,8** 65 mm 13 mm 12 **361 300 00** 17 40 07157 26509 8

**dto. in Blister / auf Karte** 12 **361 300 01** 27 40 07157 26510 4

361



Item No



EAN-Code

**Mains testing screwdriver / Spannungsprüfer** VDE 0680 220 V - 250 V

**3,5 x 1,0** 100 mm 17 mm 12 **361 350 00** 30 40 07157 26512 8

**dto. in Blister / auf Karte** 12 **361 350 01** 43 40 07157 26513 5

361



Item No



EAN-Code

**Mains testing screwdriver / Profi-Spannungsprüfer** VDE 0680 150 V - 250 V

**3,0 x 0,8** 150 mm 25 mm 12 **361 600 00** 30 40 07157 31069 9

**dto. in pouch / in Tasche** 12 **361 600 04** 41 40 07157 52743 1

361



Item No



EAN-Code

**Mains testing screwdriver / Profi-Spannungsprüfer** VDE 0680 100 V - 250 V

**3,5 x 1,0** 190 mm 25 mm 12 **361 700 00** 37 40 07157 31070 5

**dto. in pouch / in Tasche** 12 **361 700 04** 50 40 07157 52745 5

363



Item No



EAN-Code

**Automotive light tester 6 V - 24 V / Autolichtprüfer** 6 V - 24 V

**in Blister / auf Karte**

105 mm x 12 mm 12 **363 100 05** 66 40 07157 57551 7

**Fălci striate fin ce generează un grip perfect**

*finoman fogazott pofák, amelyek határozott szorítást biztosítanak*

**Partea de tăiere întărită prin inducție (60/64 HRC)**

*indukciósan edzett élek (60/64 HRC)*

**Îmbinare precisă pentru obținerea pârgheii perfecte**

*pontos illesztés az optimális erőátvitelhez*



**Rezistență anti-coroziune optima de lungă durată datorată suprafeței cromată mat.**

*a speciális matt króm felület hosszú élettartamú korrózióvédelmet biztosít*

**Performanțe de tăiere deosebite și înaltă precizie**

*kiváló vágási teljesítmény a legnagyobb pontosság mellett*

**Calitate profesională pentru utilizare Heavy Duty.**

**Clești / Fogók**

**Profeszionális minőség a nagy igénybevételhez**

**Aripioare anti-alunecare pentru mână în siguranță**

*Csúszásmentes markolat*

**Design ergonomic rafinat pentru confort maxim**

*ergonómiailag kifinomult kialakítás a tökéletes kényelemért*

**Modelele cu mâner roșu/galben sunt testate individual la 10.000 de Volți și certificate pentru 1000 de Volți - în conformitate cu standardul VDE IEC 60900:2004**

*piros / sárga modellek 10.000 Volttal egyedileg tesztelve - 1000 Voltos tanúsítvánnyal VDE IEC 60900*

**Duritate superioară ce depășește standardele DIN ISO cu până la 100%**

*kiváló keménység, amely 100%-kal meghaladja a DIN ISO követelményeket*

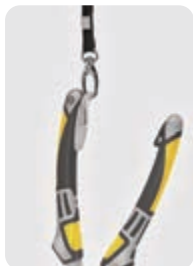

**Prindere SystemClip cu lanyard de siguranță**

*Socket SystemClip biztonsági pánttal (nem tartozék, külön rendelhető)*

**Forjat din oțel special**

*speciális acélből kovácsolva*

**Tehnologie mâner bi-component**

*kétkomponenses markolat*



**Testate GS pentru siguranță**

*GS minőségi tanúsítvány*



**Cod EAN pe fiecare produs**

*EAN vonalkód minden terméken*

**Calitatea manoperei și a materialelor garantată**

*garantáltan kiváló minőségű anyagokból*



**Clești pentru electricieni cu trăsături multifuncționale pentru muncă precisă și eficientă la cele mai înalte standard de siguranță**

*A többfunkciós villanszerelő fogók használatával pontos és hatékony munka a legmagasabb biztonsági előírások mellett.*

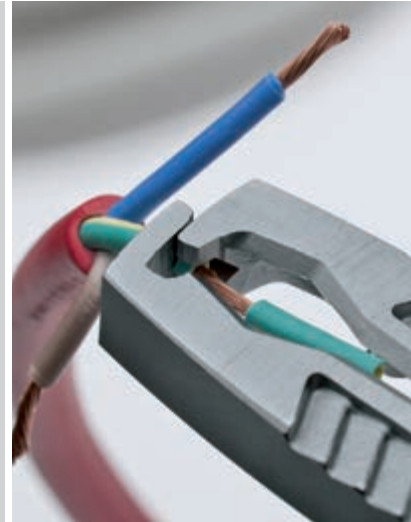

**Cleștii »felo :Inovație, design rafinat și durabilitate excepțională**

**»felo fogók: Innováció, kifinomult kialakítás és kivételes tartósság**



**Cei mai buni clești produși de către ingineria germană.**

**Îndeplinesc cele mai stricte cerințe de calitate**

*A legjobb fogók a német mérnökök és szakmunkások összefogásából. A legszigorúbb minőségi elvárásoknak is megfelel.*



**Gripping & cutting: tough work is the ultimate test for perfect tools.**

*Szorítás és vágás: hibátlan munkát és tökéletes eredményt, csakis tökéletes eszközökkel lehet elérni.*



## 580



**165 mm Combination Pliers VDE/ Kombizange VDE** 6  
**180 mm Combination Pliers VDE/ Kombizange VDE** 6

Item No

**580 016 40**  
**580 018 40**



180  
 250

EAN-Code

40 07157 63791 8  
 40 07157 63793 2

AC 1000V  
 IEC 60900 : 2012



## 581



**160 mm Diagonal Nippers VDE/ Seitenschneider** 6  
**180 mm Diagonal Nippers VDE/ Seitenschneider** 6

Item No

**581 016 40**  
**581 018 40**



210  
 240

EAN-Code

40 07157 63795 6  
 40 07157 63797 0

AC 1000V  
 IEC 60900 : 2012



## 582



**170 mm Chain Nose Radio Pliers VDE** 6  
*170 mm Telefonzange VDE (Flachrundzange)*

Item No

**582 017 40**



150

EAN-Code

40 07157 63799 4

AC 1000V  
 IEC 60900 : 2012



## 582



**205 mm Chain Nose Radio Pliers VDE** 6  
 curved 45°  
*205 mm Telefonzange VDE 45° gebogen*

Item No

**582 225 40**



200

EAN-Code

40 07157 63801 4

AC 1000V  
 IEC 60900 : 2012







AC 1000V  
IEC 60900 : 2012



**583**



Item No



EAN-Code

**160 mm Insulation Stripping Pliers**

6

**583 016 40**

180

40 07157 63803 8

*160 mm Abisolierzange*



AC 1000V  
IEC 60900 : 2012



**584**



Item No



EAN-Code

**160 mm Cable Cutter VDE**

6

**584 016 40**

305

40 07157 63805 2

*160 mm Kabelschneider VDE*



AC 1000V  
IEC 60900 : 2012



**581**



Item No



EAN-Code

**200 mm Heavy Duty Diagonal Nippers VDE**

6

**581 020 40**

305

40 07157 63807 6

*200 mm Kraftseitenschneider VDE*



AC 1000V  
IEC 60900 : 2012



## 586



Item No



EAN-Code

**180 mm Multi Cutter VDE**

6

**586 018 40**

305

40 07157 63811 3

*180 mm Multifunktionale Abisolierzange VDE*



## 580



Item No



EAN-Code

**Safety lanyard with SystemClip**

5

**580 001 00**

10

40 07157 63851 9

*Sicherungsband mit SystemClip*

## Seturile VDE: echipamentul perfect pentru profesioniști

### Szigetelt szerszámkészletek profiknak

413

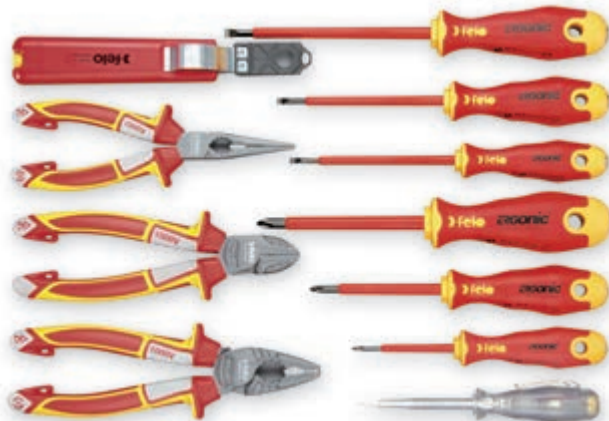

AC 1000V  
IEC 60900 : 2012

**felo**  
Innovations

Item No EAN-Code

	<b>VDE Service Kit ERGONIC 11-pcs. / Werkzeugtasche VDE11-tlg.</b>	<b>413 911 04</b>	1580	40 07157 63855 7
(3 x)	<b>413:</b>	3,5 x 0,6 / 4,0 x 0,8 / 5,5 x 1,0		
(3 x)	<b>414:</b>	PH 0 x 60 / PH 1 x 80 / PH 2 x 100		
(1 x)	<b>Mains testing Screwdriver / Spannungsprüfer</b>	3,0 mm x 70 mm (VDE 0680/6, 150-250 Volt)		
(1 x)	<b>Combination Pliers / Kombizange</b>	180 mm		
(1 x)	<b>Diagonal Nippers / Seitenschneider</b>	160 mm		
(1 x)	<b>Chain Nose Radio Pliers VDE / Telefonzange VDE (Flachrundzange)</b>	170 mm		
(1 x)	<b>Cable Stripper / Kabelmesser</b>			
	<b>Nylon bag / Nylon Tasche</b>	330 x 270 x 55 mm		



413



AC 1000V  
IEC 60900 : 2012

**felo**  
Innovations

Item No EAN-Code

	<b>VDE Service Kit E-slim 11-pcs. / Werkzeugtasche VDE E-Slim 11-tlg.</b>	<b>413 811 04</b>	1615	40 07157 63857 1
(3 x)	<b>413:</b>	3,5 x 0,6 / 4,0 x 0,8 / 5,5 x 1,0		
(2 x)	<b>414:</b>	PH 1 x 80 / PH 2 x 100		
(1 x)	<b>415:</b>	PZ 2 x 100		
(1 x)	<b>Mains testing Screwdriver / Spannungsprüfer</b>	3,0 mm x 70 mm (VDE 0680/6, 150-250 Volt)		
(1 x)	<b>Combination Pliers / Kombizange</b>	180 mm		
(1 x)	<b>Diagonal Nippers / Seitenschneider</b>	160 mm		
(1 x)	<b>Chain Nose Radio Pliers VDE / Telefonzange VDE (Flachrundzange)</b>	170 mm		
(1 x)	<b>Cable Stripper / Kabelmesser</b>			
	<b>Nylon bag / Nylon Tasche</b>	330 mm x 270 mm x 55 mm		





AC 1000V  
IEC 60900 : 2012



**felo**  
Innovations

## 413



	Item No		EAN-Code
<b>VDE Belt Pouch 9-pcs. / VDE Gürteltasche 9-tlg.</b>	<b>413 995 04</b>	1040	40 07157 63859 5
(3 x) <b>413:</b> 3,5 x 0,6 / 4,0 x 0,8 / 5,5 x 1,0			
(2 x) <b>414:</b> PH 1 x 80 / PH 2 x 100			
(1 x) <b>Mains testing Screwdriver / Spannungsprüfer</b> 3,0 mm x 70 mm (VDE 0680/6, 150-250 Volt)			
(1 x) <b>Combination Pliers / Kombizange</b> 180 mm			
(1 x) <b>Diagonal Nippers / Seitenschneider</b> 160 mm			
(1 x) <b>Cable Stripper / Kabelmesser</b>			
<b>Nylon bag / Nylon Tasche</b> 290x 250 x 20 mm			



AC 1000V  
IEC 60900 : 2012



**felo**  
Innovations

## 413



	Item No		EAN-Code
<b>XL Tool set VDE with pliers and screwdrivers 8-pcs /</b> <i>XL Werkzeugsatz VDE mit Zangen und Schraubendrehern 8-tlg.</i>	<b>413 985 17</b>	1070	40 07157 63853 3
(3 x) <b>413:</b> 3,5 x 0,6 / 4,0 x 0,8 / 5,5 x 1,0			
(2 x) <b>414:</b> PH 0 x 60 / PH 1 x 80 / PH 2 x 100			
(1 x) <b>580:</b> <b>Combination Pliers / Kombizange</b> 180 mm			
(1 x) <b>581:</b> <b>Diagonal Nippers / Seitenschneider</b> 160 mm			

## Scule de dezizolare fire / Kábelcsupaszítók

**Calitate superioară  
pentru profesioniști**  
*magas minőség  
szakembereknek*

**583**



**Automatic Wire Stripper /**  
Automatische Abisolierzange

6

**Item No**

**583 999 11**



119

**EAN-Code**

40 07157 62681 3

**Spare inside blades  
are stored in the handle**  
*Kabelmesser mit  
Ersatzklinge im Griff*



**584**

**Cable Stripper / Kabelmesser**

12

**Item No**

**584 018 11**



96

**EAN-Code**

40 07157 62683 7

**8 - 28 mm Ø**  
**5/16" - 1.1/8" Ø**



**TiN**

## Fiecare mâner calibrat și certificat individual

Minden markolat külön kalibrálva és hitelesítve

## Inel colorat ce indică gama de torsiune

színekelt markolatok



0,6 - 1,5 Nm



1,5 - 3,0 Nm



3,0 - 5,4 Nm

## Reglare facilă a torsiunii

könnyű nyomaték beállítás



## Șurubelnițe cu reglaj de torsiune de înaltă precizie Serie Nm (pat.)

Nyomatékhatárolós csavarhúzó, precíz beállítási lehetőséggel

## Design ergonomic rafinat

ergonomikus, kifinomult forma

## Lame fabricate din oțel crom-molibden-vanadium

a pengék anyaga króm-molibdén vanádium acél

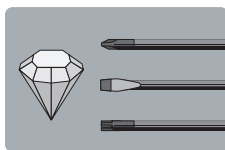

## Torsiune superioară ce depășește cerințele normelor DIN și ISO cu până la 100%

több mint 100%-kal meghaladja az ISO és DIN szabványok követelményeit

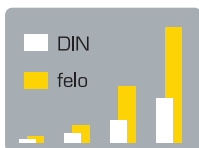

## Eliberare precisă-indicată prin semnale acustice și mecanice

pontos nyomatékhatárolás - hallható és érezhető jelzéssel

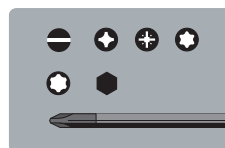

## Vârf negru pentru precizie

bevonatmentes végződés a pontos illesztésért

## Lame interschimbabile pentru o mai mare flexibilitate în toate zonele de utilizare

a cserélhető pengéknek köszönhetően végtelen felhasználási terület



## Valoare torsiune ajustabilă 0,6-5,4 Nm

beállított nyomaték 0,6 - 5,4 Nm

## torsiune desfiletare 100%

kioldó nyomaték 100%

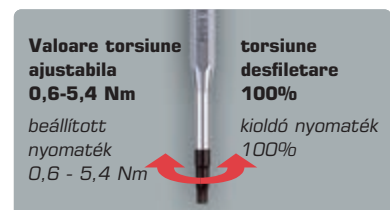



felo  
Innovations



100



	Item No		EAN-Code
<b>Nm-Box 0,6 Nm - 1,5 Nm 14-pcs. / Satz 14-tlg.</b>	<b>100 991 16</b>	1190	40 07157 52039 5
(12 x ) Torx® 6 / Torx® 7 / Torx® 8			
6 IP / 7 IP / 8 IP / 9 IP			
3,0 x 0,5 / 3,5 x 0,6			
PH 0			
PZ 0			
<b>Magnetic Bitholder / Magnethalter</b>			
<b>Handle / Griff</b> 0,6 Nm - 1,5 Nm			
<b>Adjustment Tool / Einstellschlüssel</b>			
<b>Metal Case / Metallbox:</b> 220 mm x 110 mm x 35 mm			



felo  
Innovations



100



	Item No		EAN-Code
<b>Nm-Box 1,5 Nm - 3,0 Nm 14-pcs. / Satz 14-tlg.</b>	<b>100 992 16</b>	1201	40 07157 52041 8
(12 x ) Torx® 9 / Torx® 10 / Torx® 15			
9 IP / 10 IP / 15 IP			
4,0 x 0,8			
PH 1 / PH 2			
PZ 1 / PZ 2			
<b>Magnetic Bitholder / Magnethalter</b>			
<b>Handle / Griff</b> 1,5 Nm - 3,0 Nm			
<b>Adjustment Tool / Einstellschlüssel</b>			
<b>Metal Case / Metallbox:</b> 220 mm x 110 mm x 35 mm			



felo  
Innovations



## 100



	Item No		EAN-Code
<b>Nm-Box 3,0 Nm - 5,4 Nm 14-pcs. / Satz 14-tlg.</b>	<b>100 993 16</b>	1296	40 07157 52043 2
(12 x ) Torx® 15 / Torx® 20 / Torx® 25			
9 IP / 10 IP / 15 IP			
4,0 x 0,8			
PH 1 / PH 2			
PZ 1 / PZ 2			
<b>Magnetic Bitholder / Magnethalter</b>			
<b>Handle / Griff</b> 3,0 Nm - 5,4 Nm			
<b>Adjustment Tool / Einstellschlüssel</b>			
<b>Metal Case / Metallbox:</b> 220 mm x 110 mm x 35 mm			







**100**



**felo Nm**  
Made in Germany  
0,6 Nm - 1,5 Nm

**felo Innovations**  **0,6 - 1,5 Nm**

Handle / Griff	Nm max				Item No		EAN-Code
0,6 - 1,5 Nm		105	32	1	<b>100 001 06</b>	183	40 07157 52149 1

**100**



**felo Nm**  
Made in Germany  
1,5 Nm - 3,0 Nm

**felo Innovations**  **1,5 - 3,0 Nm**





Handle / Griff	Nm max				Item No		EAN-Code
1,5 - 3,0 Nm		105	32	1	<b>100 002 06</b>	183	40 07157 52151 4

**100**





**felo Nm**  
Made in Germany  
3,0 Nm - 5,4 Nm





**felo Innovations**  **3,0 - 5,4 Nm**

Handle / Griff	Nm max				Item No		EAN-Code
3,0 - 5,4 Nm		105	32	1	<b>100 003 06</b>	192	40 07157 52153 8

**197**

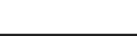





 **1/4" Adapter**

	Nm max				Item No		EAN-Code
170		170	1/4"	1	<b>197 170 04</b>	56	40 07157 62395 9

**100**

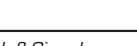

**Torque-Seal / Verschluß-Siegel**

	Nm max				Item No		EAN-Code
				1	<b>100 006 00</b>	2	40 07157 53413 2

<b>Adjusting key / Einstellschlüssel 6 mm</b>					<b>100 060 00</b>	27	40 07157 52155 2
---	--	--	--	--	-------------------	----	------------------



108



		Nm max			Item No		EAN-Code
	Torx® 6	170	1/4"	1	<b>108 061 04</b>	43	40 07157 51991 7
	Torx® 7	170	1/4"	1	<b>108 071 04</b>	43	40 07157 51993 1
	Torx® 8	170	1/4"	1	<b>108 083 04</b>	43	40 07157 51995 5
	Torx® 9	170	1/4"	1	<b>108 093 04</b>	43	40 07157 51997 9
	Torx® 10	170	1/4"	1	<b>108 103 04</b>	43	40 07157 51999 3
	Torx® 15	170	1/4"	1	<b>108 153 04</b>	44	40 07157 52001 2
	Torx® 20	170	1/4"	1	<b>108 203 04</b>	45	40 07157 52003 6
	Torx® 25	170	1/4"	1	<b>108 253 04</b>	46	40 07157 52005 0
	6 IP	170	1/4"	1	<b>109 061 04</b>	43	40 07157 52007 4
	7 IP	170	1/4"	1	<b>109 071 04</b>	43	40 07157 52009 8
	8 IP	170	1/4"	1	<b>109 083 04</b>	43	40 07157 52011 1
	9 IP	170	1/4"	1	<b>109 093 04</b>	43	40 07157 52013 5
	10 IP	170	1/4"	1	<b>109 103 04</b>	43	40 07157 52015 9
	15 IP	170	1/4"	1	<b>109 153 04</b>	44	40 07157 52017 3
	20 IP	170	1/4"	1	<b>109 203 04</b>	44	40 07157 53791 1
	25 IP	170	1/4"	1	<b>109 253 04</b>	44	40 07157 57833 4
	3,0 x 0,5	170	1/4"	1	<b>100 032 04</b>	43	40 07157 52019 7
	3,5 x 0,6	170	1/4"	1	<b>100 353 04</b>	44	40 07157 52021 0
	4,0 x 0,8	170	1/4"	1	<b>100 043 04</b>	44	40 07157 52023 4
	5,5 x 1,0	170	1/4"	1	<b>100 554 04</b>	45	40 07157 61245 8
	PH 0	170	1/4"	1	<b>102 001 04</b>	43	40 07157 52025 8
	PH 1	170	1/4"	1	<b>102 102 04</b>	45	40 07157 52027 2
	PH 2	170	1/4"	1	<b>102 203 04</b>	46	40 07157 52029 6
	PZ 0	170	1/4"	1	<b>101 001 04</b>	43	40 07157 52031 9
	PZ 1	170	1/4"	1	<b>101 102 04</b>	45	40 07157 52033 3
	PZ 2	170	1/4"	1	<b>101 203 04</b>	47	40 07157 52035 7
	H 1 (+/-)	170	1/4"	1	<b>106 102 04</b>	45	40 07157 61247 2
	H 2 (+/-)	170	1/4"	1	<b>106 203 04</b>	47	40 07157 61249 6
	Z 1 (+/-)	170	1/4"	1	<b>107 102 04</b>	45	40 07157 57807 5
	Z 2 (+/-)	170	1/4"	1	<b>107 203 04</b>	47	40 07157 57809 9
	1,5mm	170	1/4"	1	<b>104 015 04</b>	43	40 07157 61625 8
	2mm	170	1/4"	1	<b>104 020 04</b>	43	40 07157 61627 2
	2,5mm	170	1/4"	1	<b>104 025 04</b>	43	40 07157 61629 6
	3mm	170	1/4"	1	<b>104 030 04</b>	44	40 07157 61631 9
	4mm	170	1/4"	1	<b>104 040 04</b>	44	40 07157 61633 3
	Bitholder	170	1/4"	1	<b>118 125 04</b>	65	40 07157 52037 1

1/4"

# Lame slim VDE pentru Seria Nm

Testate individual conform EN 60900:2012

## Szigetelt pengék nyomaték csavarhúzóinkhoz

Egyenként tesztelve az EN 60900:2012 szerint



**Izolația cu până la 50% mai subțire!**  
50 %-kal karcsúbb szigetelés

AC 1000V  
IEC 60900 : 2012



**felo**  
Innovations

108



Nm VDE slim		Nm max			Item No		EAN-Code
3,5 x 0,6	170		1/4"	1	<b>100 353 94</b>	23	40 07157 63865 6
4,0 x 0,8	170		1/4"	1	<b>100 043 94</b>	24	40 07157 63863 2
5,5 x 1,0	170		1/4"	1	<b>100 554 94</b>	26	40 07157 63867 0
PH 1	170		1/4"	1	<b>102 102 94</b>	26	40 07157 63873 1
PH 2	170		1/4"	1	<b>102 203 94</b>	31	40 07157 63875 5
PZ 1	170		1/4"	1	<b>101 102 94</b>	26	40 07157 63869 4
PZ 2	170		1/4"	1	<b>101 203 94</b>	31	40 07157 63871 7
H2 +/-	170		1/4"	1	<b>106 203 94</b>	31	40 07157 63877 9
Z1 +/-	170		1/4"	1	<b>107 102 94</b>	31	40 07157 63879 3
Z2 +/-	170		1/4"	1	<b>107 203 94</b>	31	40 07157 63881 6



**Incorrectly fastened screws pose a serious safety hazard!**

*Fehlerhafte Verschraubungen stellen ein ernstes Sicherheitsrisiko dar!*

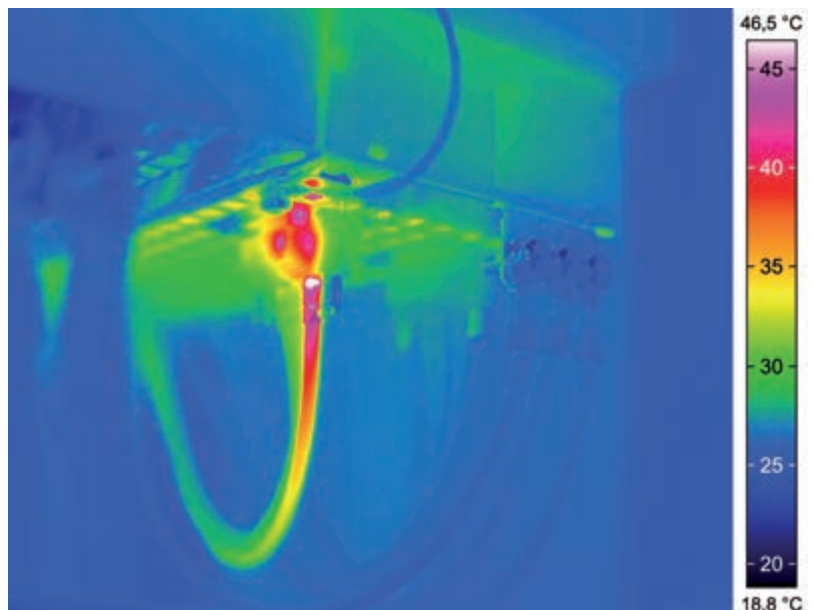

**Heavily squeezed wires may result in heat build-up.**

*Gequetschte Kabel können Hitzeentwicklung verursachen.*

**Capac rotativ independent pentru fricțiune minimă**

szabadon forgó kupak a minimális súrlódásért

**Gaură de agățare pentru depozitarea facilă**

furat a könnyebb tárolásért



**Cod EAN pe fiecare produs**

EAN vonalkód minden terméken

## Șurubelnițele de precizie Felo stabilesc standardele în toate aspectele legate de funcționalitate Serie 240/250

A FELO preciziós csavarhúzók minden szempontból megfelelnek a szabványoknak.

**Material exterior soft-grip plăcut pentru torsiune maximă**

kellemes markolat kialakítás a nagyobb kényelemért

**Design mâner anti-roll**

gurulásmentes markolat kialakítás

**Lame fabricate din oțel crom-molibden-vanadium**

a pengék anyaga króm-molibdén vanádium acél

**Torsiune superioară ce depășește cerințele normelor DIN și ISO cu până la 100%**

több mint 100%-kal meghaladja az ISO és DIN szabványok követelményeit

**Design ergonomic rafinat**

ergonomikus, kifinomult forma

**Miez mâner polipropilenă cu lungime integrală**

teljes hosszúságú polipropilén ház



**Șurubelnițele de precizie Felo sunt disponibile și cu lame ceramice conforme cu standardele ESD**

A FELO preciziós csavarhúzók kerámia pengékkel is kaphatóak, így megfelelnek az ESD szabványnak

**ESD Safe**  
10<sup>8</sup> - 10<sup>10</sup> Ω

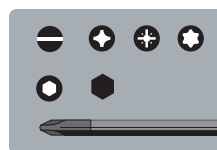

**Vârf negru pentru precizie**

bevonatmentes végződés a pontos illesztésért





## 240



							Item No		EAN-Code
<b>1,5 x 0,23</b>	60	90	14	2,5	12		<b>240 151 50</b>	20	40 07157 31738 4
<b>2,0 x 0,4</b>	60	90	14	2,5	12		<b>240 201 50</b>	20	40 07157 31740 7
<b>2,5 x 0,4</b>	60	90	14	2,5	12		<b>240 252 50</b>	20	40 07157 31742 1
<b>2,5 x 0,4</b>	150	90	14	2,5	12		<b>240 255 50</b>	24	40 07157 31744 5
<b>2,5 x 0,4</b>	200	90	14	2,5	12		<b>240 257 50</b>	25	40 07157 31746 9
<b>3,0 x 0,5</b>	60	90	14	3,0	12		<b>240 033 50</b>	22	40 07157 31748 3
<b>3,0 x 0,5</b>	100	103	19	3,0	12		<b>240 035 50</b>	24	40 07157 31750 6
<b>3,0 x 0,5</b>	200	103	19	3,0	12		<b>240 037 50</b>	29	40 07157 31752 0
<b>3,5 x 0,6</b>	60	103	19	3,0	12		<b>240 333 50</b>	24	40 07157 61307 3
<b>3,5 x 0,6</b>	100	103	19	3,5	12		<b>240 353 50</b>	26	40 07157 31754 4
<b>3,5 x 0,6</b>	150	103	19	3,5	12		<b>240 355 50</b>	31	40 07157 31756 8
<b>3,5 x 0,6</b>	250	103	19	3,5	12		<b>240 358 50</b>	39	40 07157 31758 2
<b>4,0 x 0,8</b>	100	103	19	4,0	12		<b>240 043 50</b>	30	40 07157 31760 5
<b>4,0 x 0,8</b>	150	103	19	4,0	12		<b>240 045 50</b>	35	40 07157 31762 9
<b>4,0 x 0,8</b>	200	103	19	4,0	12		<b>240 047 50</b>	40	40 07157 31764 3



## 241

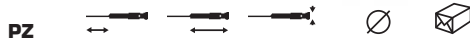

PZ							Item No		EAN-Code
<b>0</b>	60	90	14	3,0	12		<b>241 001 50</b>	19	40 07157 31766 7
<b>1</b>	60	103	19	4,5	12		<b>241 102 50</b>	29	40 07157 31768 1



## 242

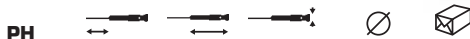

PH							Item No		EAN-Code
<b>000</b>	60	90	14	2,5	12		<b>242 000 50</b>	20	40 07157 31770 4
<b>00</b>	60	90	14	2,5	12		<b>242 009 50</b>	20	40 07157 31772 8
<b>0</b>	60	90	14	3,0	12		<b>242 001 50</b>	21	40 07157 31774 2
<b>1</b>	60	103	19	4,5	12		<b>242 102 50</b>	29	40 07157 31776 6
<b>1</b>	150	103	19	4,5	12		<b>242 105 50</b>	41	40 07157 31778 0

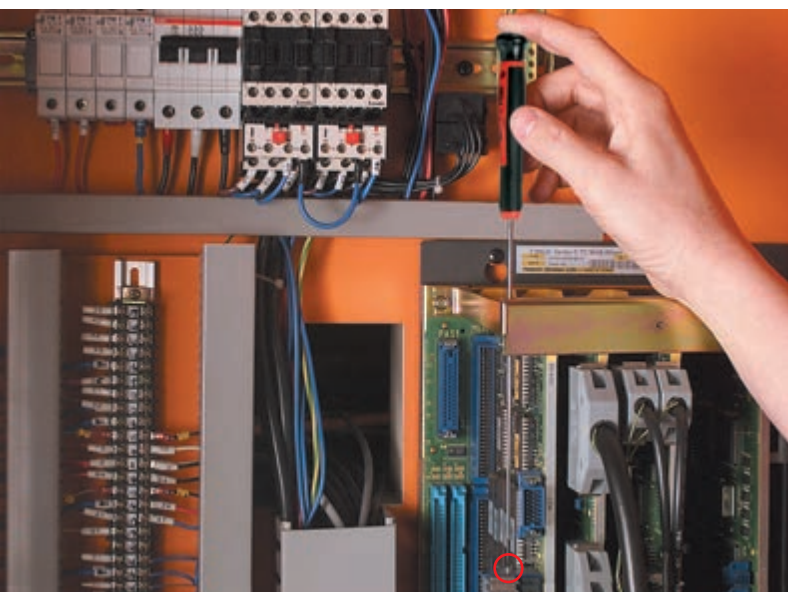

## 243



Pentalobe	←→	←→	←→	∅	📦	Item No	📦	EAN-Code
<b>P 2</b>	60	90	14	2,5	12	<b>243 021 50</b>	20	40 07157 64005 5
<b>P 5</b>	60	90	14	2,5	12	<b>243 051 50</b>	20	40 07157 64007 9
<b>P 6</b>	60	90	14	2,5	12	<b>243 061 50</b>	20	40 07157 64009 3

## 245



Tri-Wing	←→	←→	←→	∅	📦	Item No	📦	EAN-Code
<b>Y0</b>	60	90	14	2,5	12	<b>245 102 50</b>	20	40 07157 64003 1

## 246



mm	←→	←→	←→	∅	📦	Item No	📦	EAN-Code
<b>1,5</b>	60	90	14	1,5	12	<b>246 151 50</b>	17	40 07157 31782 7
<b>2</b>	60	90	14	2,0	12	<b>246 201 50</b>	19	40 07157 31784 1
<b>2,5</b>	75	90	14	2,5	12	<b>246 252 50</b>	21	40 07157 31786 5
<b>3</b>	75	103	19	3,0	12	<b>246 302 50</b>	23	40 07157 31788 9

## 248



Torx®	←→	←→	←→	∅	📦	Item No	📦	EAN-Code
<b>5</b>	60	90	14	3,0	12	<b>248 051 50</b>	20	40 07157 31790 2
<b>6</b>	60	90	14	3,0	12	<b>248 061 50</b>	20	40 07157 31792 6
<b>7</b>	60	90	14	3,0	12	<b>248 071 50</b>	21	40 07157 31794 0
<b>8</b>	60	90	14	3,0	12	<b>248 081 50</b>	22	40 07157 31796 4
<b>9</b>	60	90	14	3,5	12	<b>248 091 50</b>	22	40 07157 31798 8
<b>10</b>	60	103	19	3,5	12	<b>248 103 50</b>	26	40 07157 31800 8
<b>10</b>	250	103	19	3,5	6	<b>248 108 50</b>	38	40 07157 50276 6
<b>15</b>	100	103	19	4,0	12	<b>248 153 50</b>	30	40 07157 31802 2
<b>15</b>	250	103	19	4,0	6	<b>248 158 50</b>	45	40 07157 50278 0
<b>20</b>	250	103	19	4,0	6	<b>248 208 50</b>	61	40 07157 50280 3

## 249



mm	←→	←→	←→	∅	📦	Item No	📦	EAN-Code
<b>3</b>	60	103	19		6	<b>249 300 50</b>	29	40 07157 50709 9
<b>3,5</b>	60	103	19		6	<b>249 350 50</b>	29	40 07157 50711 2
<b>4</b>	60	103	19		6	<b>249 400 50</b>	30	40 07157 50713 6
<b>4,5</b>	60	103	19		6	<b>249 450 50</b>	30	40 07157 50715 0
<b>5</b>	60	103	19		6	<b>249 500 50</b>	31	40 07157 50717 4
<b>5,5</b>	60	103	19		6	<b>249 550 50</b>	31	40 07157 50719 8



## 240



	Item No		EAN-Code
<b>Box 6-pcs. / Box 6-tlg.</b>	<b>240 961 56</b>	195	40 07157 31844 2
(4 x) <b>240:</b> 1,5 x 60 / 2,0 x 60 / 2,5 x 60 / 3,0 x 60			
(2 x) <b>242:</b> Phillips 00 x 60 / Phillips 0 x 60			
<b>Box 6-pcs. / Box 6-tlg.</b>	<b>248 961 56</b>	194	40 07157 31846 6
(4 x) <b>248:</b> Torx® 6 x 60 / Torx® 7 x 60 / Torx® 8 x 60 / Torx® 9 x 60			
(2 x) <b>246:</b> 1,5 mm x 60 mm / 2,0 mm x 60 mm			



## 243



	Item No		EAN-Code
<b>Precision screwdriver set, 6-pcs. /</b> <i>Präzisionserschraubendreher Satz, 6-tlg.</i>	<b>243 961 56</b>	254	40 07157 64011 6
(1 x) <b>240:</b> 2,5 x 0,4			
(1 x) <b>242:</b> PH 000			
(3 x) <b>243:</b> P 2 / P 5 / P 6			
(1 x) <b>245:</b> Tri Wing Y 0			



## 249



	Item No		EAN-Code
<b>Box 6-pcs. / Box 6-tlg.</b>	<b>249 961 56</b>	254	40 07157 50721 1
(6 x) <b>249:</b> 3,0 mm x 60 mm / 3,5 mm x 60 mm / 4,0 mm x 60 mm 4,5 mm x 60 mm / 5,0 mm x 60 mm / 5,5 mm x 60 mm			



## 245



	Item No		EAN-Code
<b>Watchmaker Screwdriver Set, 6-pcs.</b> <i>Uhrmacher Schraubendreher Satz, 6-tlg.</i>	<b>245 961 06</b>	300	40 07157 63357 6
(6 x) <b>245:</b> 1,0 / 1,5 / 1,8 / 2,3 / 2,9 / 3,6			



## 280



	Item No		EAN-Code
<b>T4-Box 7-pcs. / T-Box.7-tlg.</b> (6 x ) <b>Blade / Klinge</b>	<b>280 907 06</b>	163	40 07157 50723 5
1,5 - 3,0 / 2,0 - 3,5 / 2,5 - 4,0			
PH 1 - PH 0 / PH 00 - PH 000			
PZ 1 - PZ 0			
<b>Handle / Griff 102 x 19 mm</b>			



<b>T4-Box 7-pcs. / T-Box.7-tlg.</b> (6 x ) <b>Blade / Klinge</b>	<b>280 907 16</b>	171	40 07157 50725 9
1,3 mm - 4,0 mm / 1,5 mm - 2,0 mm / 2,5 mm - 3,0 mm			
Torx® 6 - Torx® 15 / Torx® 7 - Torx® 10 / Torx® 8 - Torx® 9			
<b>Handle / Griff 102 x 19 mm</b>			



<b>T4-Box 7-pcs. / T-Box.7-tlg.</b> (6 x ) <b>Blade / Klinge</b>	<b>280 907 26</b>	164	40 07157 50727 3
2,0 - 3,5			
PH1 - PH 0 / PH 00 - PH 000			
Torx® 6 - Torx® 15 / Torx® 7 - Torx® 10 / Torx® 8 - Torx® 9			
<b>Handle / Griff 102 x 19 mm</b>			

## 280



				Item No		EAN-Code
<b>1,5 x 0,25 - 3,0 x 0,5</b>	110 mm	4 mm	1	<b>280 153 14</b>	16	40 07157 50729 7
<b>2,0 x 0,4 - 3,5 x 0,6</b>	110 mm	4 mm	1	<b>280 235 14</b>	16	40 07157 50731 0
<b>2,5 x 0,4 - 4,0 x 0,8</b>	110 mm	4 mm	1	<b>280 245 14</b>	16	40 07157 50733 4
<b>PH 00 - PH 000</b>	110 mm	4 mm	1	<b>282 000 14</b>	16	40 07157 50737 2
<b>PH 1 - PH 0</b>	110 mm	4 mm	1	<b>282 001 14</b>	16	40 07157 50735 8
<b>PZ 1 - PZ 0</b>	110 mm	4 mm	1	<b>281 010 14</b>	16	40 07157 50739 6
<b>1,3 mm - 4 mm</b>	110 mm	4 mm	1	<b>284 134 14</b>	16	40 07157 50741 9
<b>1,5 mm - 2 mm</b>	110 mm	4 mm	1	<b>284 152 14</b>	16	40 07157 50743 3
<b>2,5 mm - 3 mm</b>	110 mm	4 mm	1	<b>284 253 14</b>	16	40 07157 50745 7
<b>Torx® 6 - Torx® 15</b>	110 mm	4 mm	1	<b>286 615 14</b>	16	40 07157 50747 1
<b>Torx® 7 - Torx® 10</b>	110 mm	4 mm	1	<b>286 710 14</b>	16	40 07157 50749 5
<b>Torx® 8 - Torx® 9</b>	110 mm	4 mm	1	<b>286 890 14</b>	16	40 07157 50751 8









250



ESD Safe  
 $10^8 - 10^{10} \Omega$







							Item No		EAN-Code
	<b>1,5 x 0,23</b>	60	102	19	2,5	12	<b>250 151 80</b>	20	40 07157 31806 0
	<b>2,0 x 0,4</b>	60	102	19	2,5	12	<b>250 201 80</b>	21	40 07157 31808 4
	<b>2,5 x 0,4</b>	60	102	19	2,5	12	<b>250 252 80</b>	21	40 07157 31810 7
	<b>3,0 x 0,5</b>	60	102	19	3,0	12	<b>250 033 80</b>	23	40 07157 31812 1
	<b>3,0 x 0,5</b>	100	102	19	3,0	12	<b>250 035 80</b>	24	40 07157 31814 5

252

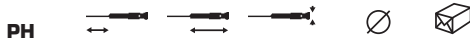

ESD Safe  
 $10^8 - 10^{10} \Omega$







PH							Item No		EAN-Code
	<b>00</b>	60	102	19	2,0	12	<b>252 009 80</b>	20	40 07157 31816 9
	<b>0</b>	60	102	19	3,0	12	<b>252 001 80</b>	22	40 07157 31818 3
	<b>1</b>	80	102	19	4,5	12	<b>252 102 80</b>	32	40 07157 31820 6

250



ESD Safe  
 $10^8 - 10^{10} \Omega$



							Item No		EAN-Code	
	<b>ESD-Box 6-pcs. / ESD-Box.6-tlg.</b>						<b>250 961 86</b>	202	40 07157 31848 0	
	(4 x ) <b>250:</b>	1,5 x 60 / 2,0 x 60 / 2,5 x 60 / 3,0 x 60								
	(2 x ) <b>252:</b>	Phillips 00 x 60 / Phillips 0 x 60								



### Depozit telescopic pentru 7 biți

teleszkópos bittartó 7 bit számára



### Mâner ergonomic rafinat conceput pentru cel mai înalt nivel de confort și utilizare heavy-duty

ergonomikus kialakítású kényelmes markolat a legnehezebb igénybevételhez is

### Mâner fin, fara îmbinări, pentru confort maxim

kellemes markolat kialakítás a nagyobb kényelemért

### Biți accesibili ușor, depozitați în siguranță în interiorul mânerului

könnyen és biztonságosan tárolható bitek a markolatban

### Material exterior soft-grip plăcut pentru torsiune maximă

kellemes tapintású markolat a legnagyobb nyomaték átvitelével

Versatilitate universală și ergonomie avansată și

## Serie 370 (pat.)

Sokoldalúság és fejlett ergonómia



## Serie 373

### Cu adaptor magnetic pentru folosirea cu scule electrice

csavarbehajtó gépekhez használható bittartóval

### Adaptor magnetic cu manșon din inox și magnet extreme de puternic

bittartó rozsdamentes acélhüvellyel és rendkívül erős mágnessel



## Serie 374

### Șurubelniță magazie cu clichet

Magazin-markolat, racsni behajtóval

### Clichet profesional reversibil Torsiune maxima >24Nm

Irányváltós racsni, 24 Nm nyomatékig



### Display-uri vânzare la pagina 199

Kereskedelmi bemutató-állvány a 199. oldalon



373



Item No



EAN-Code

(8 x)	<b>Magazine Handle with bitholder for power tool on card</b>	6	<b>373 108 05</b>	160	40 07157 52227 6
	<i>Magazingriff mit Bithalter für Akkuwerkzeug auf Karte</i>				
	0,6 x 4,5 / 1,0 x 5,5 / 1,2 x 6,5				
	PH 0 / PH 1 / PH 2 / PZ 1 / PZ 2				

(8 x)	<b>Magazine Handle with bitholder for power tool on card</b>	6	<b>373 208 05</b>	161	40 07157 52229 0
	<i>Magazingriff mit Bithalter für Akkuwerkzeug auf Karte</i>				
	Bits C 6,3 x 25 mm				
	1,0 x 5,5				
	PH 1 / PH 2 / PZ 1 / PZ 2				
	Torx® 15 / Torx® 20 / Torx® 25				

374



Item No



EAN-Code

(1 x)	<b>Magazine Handle with Ratchet on card</b>	6	<b>374 004 05</b>	229	40 07157 52223 8
	<i>Magazingriff mit Ratsche auf Karte</i>				
(8 x)	Bits C 6,3 x 25 mm				
	0,6 x 4,5 / 1,0 x 5,5 / 1,2 x 6,5				
	PH 0 / PH 1 / PH 2 / PZ 1 / PZ 2				

(1 x)	<b>Magazine Handle with Ratchet on card</b>	6	<b>374 204 05</b>	229	40 07157 52225 2
	<i>Magazingriff mit Ratsche auf Karte</i>				
(8 x)	Bits C 6,3 x 25 mm				
	1,0 x 5,5				
	PH 1 / PH 2 / PZ 1 / PZ 2				
	Torx® 15 / Torx® 20 / Torx® 25				

376



Item No



EAN-Code

(1 x)	<b>Magazine Handle Bitholder (long) on card</b>	6	<b>376 041 05</b>	188	40 07157 52221 4
	<i>Magazingriff Bithalter (lang) auf Karte</i>				
(8 x)	Bits C 6,3 x 25 mm				
	0,6 x 4,5 / 1,0 x 5,5 / 1,2 x 6,5				
	PH 0 / PH 1 / PH 2 / PZ 1 / PZ 2				

(1 x)	<b>Magazine Handle Bitholder (long) on card</b>	6	<b>376 044 05</b>	188	40 07157 52569 7
	<i>Magazingriff Bithalter (lang) auf Karte</i>				
(8 x)	Bits C 6,3 x 25 mm				
	1,0 x 5,5				
	PH 1 / PH 2 / PZ 1 / PZ 2				
	Torx® 15 / Torx® 20 / Torx® 25				

## Înveliș soft-grip ergonomic rafinat

*Kifinomult markolat*

## Mâner bi-component pentru confort sport

*kétkomponensű markolat a még nagyobb kényelemért*



## Facute de profesioniști pentru profesioniști

# Mâner în T/ T-markolat

*Profi gyártótól, profi felhasználóknak*

## Miez puternic și durabil pentru cele mai mari torsiuni

*erős, tartós markolat a legmagasabb nyomatékért*

## Gaură de agățare pentru depozitarea facilă

*furat a könnyebb tárolásért*

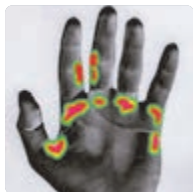

## Fara învelișul soft-grip:puncte extreme de presiune

*puha markolatborítás nélkül túlterhelt pontok a tenyérben*



## Cu învelișul soft-grip:puncte de presiune reduse

*puha markolatborítással kevésbé terhelt pontok a tenyérben*

## Cod EAN pe fiecare produs

*EAN vonalkód minden terméken*



## Lame fabricate din oțel crom-vanadium și oțel crom-molibden-vanadium

*a pengék anyaga króm-molibdén vanádium acél*

## Lame din crom cu finisaj mat cu vărfuri negre pentru precizie

*matt, króm bevonatú pengék és bevonatmentes végződés a pontos illesztésért*

## Torsiune superioară ce depășește cerințele normelor DIN și ISO cu până la 100%





*több mint 100%-kal meghaladja az ISO és DIN szabványok követelményeit*





## 303







mm					Item No		EAN-Code
<b>2</b>	100	100	2,0	12	<b>303 203 80</b>	58	40 07157 32248 7
<b>2,5</b>	100	100	2,5	12	<b>303 253 80</b>	60	40 07157 32250 0
<b>3</b>	150	100	3,0	8	<b>303 035 80</b>	66	40 07157 32252 4
<b>4</b>	150	100	4,0	8	<b>303 045 80</b>	74	40 07157 32254 8
<b>5</b>	150	100	5,0	8	<b>303 055 80</b>	84	40 07157 32256 2
<b>6</b>	150	100	6,0	8	<b>303 065 80</b>	100	40 07157 32258 6
<b>8</b>	150	100	8,0	8	<b>303 085 80</b>	134	40 07157 32260 9
<b>8</b>	200	100	8,0	8	<b>303 087 80</b>	155	40 07157 32262 3
<b>10</b>	200	100	10,0	8	<b>303 107 80</b>	198	40 07157 32264 7



## 304



mm				Item No		EAN-Code
<b>5,5</b>	230	100	8	<b>304 558 80</b>	113	40 07157 32266 1
<b>6</b>	125	100	8	<b>304 064 80</b>	94	40 07157 32296 8
<b>6</b>	230	100	8	<b>304 068 80</b>	167	40 07157 32268 5
<b>7</b>	230	100	8	<b>304 078 80</b>	138	40 07157 32270 8
<b>8</b>	125	100	8	<b>304 084 80</b>	109	40 07157 32300 2
<b>8</b>	230	100	8	<b>304 088 80</b>	141	40 07157 32272 2
<b>8</b>	350	100	8	<b>304 089 80</b>	177	40 07157 32274 6
<b>9</b>	230	100	8	<b>304 098 80</b>	142	40 07157 32276 0
<b>10</b>	125	100	8	<b>304 104 80</b>	124	40 07157 32304 0
<b>10</b>	230	100	8	<b>304 108 80</b>	166	40 07157 32278 4
<b>10</b>	350	100	8	<b>304 109 80</b>	213	40 07157 32280 7
<b>11</b>	230	100	8	<b>304 118 80</b>	174	40 07157 32282 1
<b>12</b>	230	100	8	<b>304 128 80</b>	175	40 07157 32284 5
<b>13</b>	125	100	8	<b>304 134 80</b>	138	40 07157 32310 1
<b>13</b>	230	100	8	<b>304 138 80</b>	177	40 07157 32286 9
<b>13</b>	350	100	8	<b>304 139 80</b>	225	40 07157 32288 3
<b>17</b>	230	100	8	<b>304 178 80</b>	202	40 07157 32292 0



## 308



Torx®			∅		Item No		EAN-Code
10	125	100	3,5	8	<b>308 103 80</b>	64	40 07157 50813 3
15	125	100	4,0	8	<b>308 153 80</b>	68	40 07157 50815 7
20	125	100	5,0	8	<b>308 204 80</b>	78	40 07157 32316 3
20	200	100	5,0	8	<b>308 207 80</b>	88	40 07157 32318 7
25	125	100	5,0	8	<b>308 254 80</b>	78	40 07157 32320 0
25	200	100	5,0	8	<b>308 257 80</b>	89	40 07157 32322 4
27	200	100	5,0	8	<b>308 277 80</b>	88	40 07157 32324 8
30	200	100	6,0	8	<b>308 307 80</b>	106	40 07157 32326 2
40	200	100	8,0	8	<b>308 407 80</b>	142	40 07157 32328 6
45	140	100	8,0	8	<b>308 455 80</b>	124	40 07157 32330 9



## 397



				Item No		EAN-Code
<b>T-Handle with square adapter / T-Griff mit 4-Kant Adapter</b>						
1/2"	125	100	6	<b>397 127 80</b>	150	40 07157 62897 8
1/4"	125	100	6	<b>397 635 80</b>	103	40 07157 62899 2
3/8"	125	100	6	<b>397 952 80</b>	135	40 07157 62901 2



## 338



				Item No		EAN-Code
1/4"	125	100	6	<b>338 125 80</b>	111	40 07157 32350 7





# 340



Item No



EAN-Code



<b>4,0 x 0,8</b>	125 mm	4,0 mm	12	<b>340 040 00</b>	13	40 07157 31018 7
<i>dto. in pouch / in Tasche</i>				<b>340 040 04</b>	21	40 07157 57555 5
<b>5,5 x 1,0</b>	135 mm	5,5 mm	12	<b>340 055 00</b>	28	40 07157 31019 4
<i>dto. in pouch / in Tasche</i>				<b>340 055 04</b>	36	40 07157 57559 3
<b>8,0 x 1,2</b>	200 mm	8,0 mm	12	<b>340 080 00</b>	89	40 07157 26004 8
<i>dto. in pouch / in Tasche</i>				<b>340 080 04</b>	101	40 07157 57793 1



**PZ**

<b>1 + 2</b>	135 mm	6,0 mm	12	<b>341 120 00</b>	35	40 07157 26006 2
<i>dto. in pouch / in Tasche</i>				<b>341 120 04</b>	43	40 07157 57561 6
<b>3 + 4</b>	200 mm	8,0 mm	12	<b>341 340 00</b>	74	40 07157 26008 6
<i>dto. in pouch / in Tasche</i>				<b>341 340 04</b>	82	40 07157 57565 4



**PH**

<b>1 + 2</b>	135 mm	6,0 mm	12	<b>342 120 00</b>	35	40 07157 26010 9
<i>dto. in pouch / in Tasche</i>				<b>342 120 04</b>	43	40 07157 57563 0
<b>3 + 4</b>	200 mm	8,0 mm	12	<b>342 340 00</b>	94	40 07157 26012 3
<i>dto. in pouch / in Tasche</i>				<b>342 340 04</b>	106	40 07157 57795 5



**PH**



<b>6,0 + PH 2</b>	135 mm	6,0 mm	12	<b>343 260 00</b>	35	40 07157 26014 7
<i>dto. in pouch / in Tasche</i>				<b>343 260 04</b>	44	40 07157 57557 9

## Formă hexagonală optimă, formată cu precizie

Pontos méretek, precíz kialakítás

## Măner virtual indestructibil

gyakorlatilag elpusztíthatatlan markolat

## Făcute din aliaj special de înalta torsiune American (Protanium™)

speciális, nagy csavarónyomatékú acéltövezetből (Protanium™)

## Protecție anti-rugină mai mare cu 30% datorită tratamentului de suprafață unic

Egyedülálló szerszámbevonat, 30 %-kal növeli a rozsdavédelmet

## Hatszögkulcsok

## Chei hexagonale/ Imbusuri

## Hatszögkulcsok verhetetlen minőségben

## Imbusuri de o calitate înaltă, fără compromisuri

## Design îmbunătățit ergonomic pentru a preveni răniile

ergonomikus kialakítás a sérülések elkerülése érdekében

## Tratamentul termic atent executat garantează un raport optim între duritate și elasticitate

Az egyedi hőkezelés optimalizálja a keménységet és rugalmasságot

## Nivel de torsiune ce depășește pe cel al concurenței cu până la 20%

20 %-kal nagyobb csavarónyomaték, mint bármely más szerszámgyártónál

## Suprafața cromată mat

mat króm bevonat

 **QUALITY**  
Made in USA

## Brat extra-lung pentru efect de pârghie maxim

extra hosszú szerszám a nagyobb erőkarért

## Vârf negru pentru precizie

bevonatmentes végződés a pontos illesztésért

## Rază de mișcare a lamei de peste 270° = salvator de timp datorită eliminării nevoii de a ieși și reentra în șurub

270° visszahajtási lehetőség, a folyamatos munkavégzés érdekében

## Vârf ballpoint extrem de precis chiar și la măsurile cele mai mici

pontosan megmunkált gömbvég, még a legkisebb méretben is



## zone de contact proiectate precis

pontos kialakítás a könnyebb illeszthetőségért







### 348



Torx®									Item No		EAN-Code
5	33	19		2,5	3				<b>348 105 50</b>	3	40 07157 53317 3
6	33	19		2,5	3				<b>348 106 50</b>	3	40 07157 53319 7
7	33	19		2,5	3				<b>348 107 50</b>	4	40 07157 53321 0
8	33	19		2,5	3				<b>348 108 50</b>	4	40 07157 53323 4
9	37	24		3,0	3				<b>348 109 50</b>	5	40 07157 53325 8
10	37	24		3,0	3				<b>348 110 50</b>	6	40 07157 53327 2
15	43	28		4,0	3				<b>348 115 50</b>	8	40 07157 53329 6
20	43	28		4,0	3				<b>348 120 50</b>	11	40 07157 53331 9



### 349



Torx Plus®									Item No		EAN-Code
5 IP	33	19		2,5	3				<b>349 105 50</b>	3	40 07157 53333 3
6 IP	33	19		2,5	3				<b>349 106 50</b>	3	40 07157 53335 7
7 IP	33	19		2,5	3				<b>349 107 50</b>	4	40 07157 53337 1
8 IP	33	19		2,5	3				<b>349 108 50</b>	4	40 07157 53339 5
9 IP	37	24		3,0	3				<b>349 109 50</b>	5	40 07157 53341 8
10 IP	37	24		3,0	3				<b>349 110 50</b>	6	40 07157 53343 2
15 IP	43	28		4,0	3				<b>349 115 50</b>	8	40 07157 53345 6
20 IP	43	28		4,0	3				<b>349 120 50</b>	11	40 07157 53347 0





### 348



Torx®								Item No		EAN-Code
<b>set 7-pcs. / Satz 7-tlg.</b>								<b>348 907 50</b>	71	40 07157 60393 7
[7 x ] <b>348:</b> Torx® 6 / Torx® 7 / Torx® 8 / Torx® 9										
Torx® 10 / Torx® 15 / Torx® 20										



## 349

Torx Plus®  



Item No



EAN-Code

set 7-pcs. / Satz 7-tlg.

349 907 50

71

40 07157 60395 1

[7 x] 349: 6 IP / 7 IP / 8 IP / 9 IP  
10 IP / 15 IP / 20 IP

## 348



Torx®



Item No



EAN-Code

				Item No		EAN-Code
6	42	2,5	12	348 006 00	2	40 07157 30742 2
7	48	2,5	12	348 007 00	2	40 07157 30743 9
8	48	2,5	12	348 008 00	2	40 07157 30744 6
9	48	3,0	12	348 009 00	2	40 07157 30745 3
10	86	3,5	12	348 010 00	7	40 07157 26054 3
15	91	3,5	12	348 015 00	8	40 07157 26055 0
20	95	4,0	12	348 020 00	11	40 07157 26056 7
25	100	5,0	12	348 025 00	17	40 07157 26057 4
27	105	6,0	12	348 027 00	27	40 07157 26058 1
30	115	6,0	12	348 030 00	30	40 07157 26059 8
40	124	8,0	12	348 040 00	56	40 07157 26060 4
45	133	8,0	12	348 045 00	61	40 07157 26061 1
50	152	9,0	12	348 050 00	88	40 07157 30746 0
55	172	12,0	12	348 055 00	161	40 07157 30747 7
60	190	13,5	12	348 060 00	248	40 07157 30748 4

## 348



Item No



EAN-Code

Set, 8-pcs. / Satz 8-tlg.

6

348 888 01

150

40 07157 62533 5

Torx® 09 / Torx® 10 / Torx® 15 / Torx® 20 / Torx® 25 / Torx® 27 / Torx® 30 / Torx® 40

 QUALITY  
Made in USA



**QUALITY**  
Made in USA

**348**



		Item No		EAN-Code
<b>TF 8 Fold-Up / Handklapphalter</b>	6	<b>348 088 01</b>	156	40 07157 60401 9
Torx® 9 / Torx® 10 / Torx® 15 / Torx® 20 / Torx® 25				
Torx® 27 / Torx® 30 / Torx® 40				



**QUALITY**  
Made in USA

**348**



		Item No		EAN-Code
<b>LTX 8 Torx®-Ballpoint Set, 8-pcs. /</b>	6	<b>348 080 01</b>	150	40 07157 60403 3
<i>LTX 8 Torx®-Kugelkopf Satz 8-tlg.</i>				
Torx® 09 / Torx® 10 / Torx® 15 / Torx® 20 / Torx® 25 / Torx® 27 / Torx® 30 / Torx® 40				



## 345



 **QUALITY**  
Made in USA



				Item No		EAN-Code
<b>1,5 mm</b>	46,5	1,5	100	<b>345 015 00</b>	1	40 07157 26017 8
<b>2,0 mm</b>	52	2,0	100	<b>345 020 00</b>	2	40 07157 26018 5
<b>2,5 mm</b>	58,5	2,5	100	<b>345 025 00</b>	3	40 07157 26019 2
<b>3,0 mm</b>	66	3,0	100	<b>345 030 00</b>	5	40 07157 26020 8
<b>4,0 mm</b>	74	4,0	100	<b>345 040 00</b>	10	40 07157 26021 5
<b>5,0 mm</b>	85	5,0	100	<b>345 050 00</b>	18	40 07157 26022 2
<b>6,0 mm</b>	96	6,0	50	<b>345 060 00</b>	29	40 07157 26023 9
<b>8,0 mm</b>	108	8,0	50	<b>345 080 00</b>	58	40 07157 26024 6
<b>10,0 mm</b>	122	10,0	25	<b>345 100 00</b>	102	40 07157 26025 3
<b>12,0 mm</b>	137	12,0	10	<b>345 120 00</b>	162	40 07157 26026 0
<b>14,0 mm</b>	154	14,0	10	<b>345 140 00</b>	256	40 07157 26027 7
<b>17,0 mm</b>	177	17,0	5	<b>345 170 00</b>	431	40 07157 26028 4

## 355



 **QUALITY**  
Made in USA







				Item No		EAN-Code
<b>1,5 mm</b>	80	1,5	10	<b>355 015 00</b>	1	40 07157 31022 4
<b>2,0 mm</b>	85	2,0	10	<b>355 020 00</b>	3	40 07157 31023 1
<b>2,5 mm</b>	90	2,5	10	<b>355 025 00</b>	4	40 07157 19082 6
<b>3,0 mm</b>	100	3,0	10	<b>355 030 00</b>	7	40 07157 19083 3
<b>4,0 mm</b>	112	4,0	10	<b>355 040 00</b>	14	40 07157 19084 0
<b>5,0 mm</b>	121	5,0	10	<b>355 050 00</b>	25	40 07157 19085 7
<b>6,0 mm</b>	140	6,0	10	<b>355 060 00</b>	41	40 07157 19086 4
<b>8,0 mm</b>	163	8,0	10	<b>355 080 00</b>	85	40 07157 19087 1
<b>10,0 mm</b>	190	10,0	5	<b>355 100 00</b>	152	40 07157 19088 8



 **QUALITY**  
Made in USA

**365**







				Item No		EAN-Code
<b>1,5 mm</b>	92	1,5	10	<b>365 015 00</b>	2	40 07157 50314 5
<b>2,0 mm</b>	102	2,0	10	<b>365 020 00</b>	3	40 07157 50316 9
<b>2,5 mm</b>	114	2,5	10	<b>365 025 00</b>	5	40 07157 50318 3
<b>3,0 mm</b>	128	3,0	10	<b>365 030 00</b>	9	40 07157 50320 6
<b>4,0 mm</b>	144	4,0	10	<b>365 040 00</b>	18	40 07157 50322 0
<b>5,0 mm</b>	162	5,0	10	<b>365 050 00</b>	32	40 07157 50324 4
<b>6,0 mm</b>	173	6,0	10	<b>365 060 00</b>	49	40 07157 50326 8
<b>8,0 mm</b>	197	8,0	10	<b>365 080 00</b>	99	40 07157 50328 2
<b>10,0 mm</b>	226	10,0	5	<b>365 100 00</b>	178	40 07157 50330 5



 **QUALITY**  
Made in USA

**365**



				Item No		EAN-Code
<b>BLX 9 extra long Set 9-pcs. Series 355</b>			6	<b>365 009 01</b>	454	40 07157 60397 5
<i>BLX 9 Extra langer Satz 9 tlg. Serie 355</i>						
1,5 mm / 2,0 mm / 2,5 mm / 3,0 mm / 4,0 mm						
5,0 mm / 6,0 mm / 8,0 mm / 10,0 mm						



**QUALITY**  
Made in USA

**345**



		Item No		EAN-Code
<b>HF 7M Fold-Up / Handklapphalter</b>	6	<b>345 007 01</b>	179	40 07157 60399 9
2,0 mm / 2,5 mm / 3,0 mm / 4,0 mm				
5,0 mm / 6,0 mm / 8,0 mm				



**QUALITY**  
Made in USA

**345**



		Item No		EAN-Code
<b>BLX 6 Set 6-pcs. Short version, nickel plated</b>	12	<b>345 006 01</b>	64	40 07157 60405 7
<i>BLX 6 Satz 6-tlg. kurze Version, vernickelt</i>				
1,5 mm / 2,0 mm / 2,5 mm / 3,0 mm / 4,0 mm / 5,0 mm				

# 355



**QUALITY**  
Made in USA



**Item No**



**EAN-Code**

**BLX 9 Set 9-pcs. Series 355**

6

**355 009 01**

363

40 07157 60407 1

*BLX 9 Satz 9-tlg. Serie 355*

1,5 mm / 2,0 mm / 2,5 mm / 3,0 mm / 4,0 mm

5,0 mm / 6,0 mm / 8,0 mm / 10,0 mm

# 355



**QUALITY**  
Made in USA



**Item No**



**EAN-Code**

**BLX 15 Set 15-pcs. Series 355**

6

**355 150 01**

653

40 07157 60409 5

*BLX 15 Satz 15-tlg. Serie 355*

1,27 / 1,5 mm / 2,0 mm / 2,5 mm / 3,0 mm / 3,5 mm

4,0 mm / 4,5 mm / 5,0 mm / 5,5 mm / 6,0 mm / 7,0 mm

8,0 mm / 9,0 mm / 10,0 mm

# 375



**QUALITY**  
Made in USA



**Item No**



**EAN-Code**

**BLX 13 Set 13-pcs. Inch Sizes**

6

**375 130 01**

399

40 07157 60411 8

*BLX 13 Satz 13-tlg. Zoll-Abmessungen*

.050 1/16 5/64 3/32 7/64 1/8

9/64 5/32 3/16 7/32 1/4 5/16 3/8

**Mechanism cliche extrem de rezistent cu dinți super-fini (>100Nm, 72 dinți, 5° unghi cliche).**

*Extra erős racsniszerkezet: szuper finomságú fogaskerékkel (>100Nm, 72 fog, csak 5° hajtási szög)*



**Cheile tubulare se blochează în siguranță și pot fi schimbate ușor printr-o apăsare de buton**

*Biztonságos dugókulcs tartás és eltávolítás a rögzítő gomb segítségével*

**Mânerul conectat inseparabil de partea metalică a clicheului**

*Szabadalmaztatott ERGONIC markolat a tökéletes kényelemért!*

## R-GO

**Seturi de scule 1/4" cu cliche ERGONIC: perfect și de încredere, fără compromisuri!**



EP 1963072

**Mâner patentat ERGONIC cu efect de amortizare: confortul la superlativ!**

*Szabadalmaztatott ERGONIC markolat a tökéletes kényelemért!*

**Compoziții orientate pe meserii, depozitate în cutiile robuste StrongBox.**

*A legfontosabb szerszámok egy extraerős tároló dobozban*

**Calitate premium cu o durată lungă de viață, în fiecare detaliu: 15 ani garanție pentru fiecare componentă**

*Hosszantartó prémium szerszámok, minden alkatrészre 15 év garancia!*





Seturile de scule R-GO 1/4" conțin o combinație bine gândită de biți de înaltă calitate și precizie, chei tubulare, adaptori și extensii pentru o mare varietate de folosințe, chiar și împreună cu scule electrice.

Az R-GO szerszám dobozokban a legfontosabb szerszámok gyűjteményét találja. Bitek, dugókulcsok, átalakítók és egy kiváló racsnit találhat az erős és jól záródó gumírozott éllel és sarkokkal ellátott dobozban.

1/4" szerszámkészlet ERGONIC racsnival:  
tökéletes és megbízható

Clichetul R-GO și toate celelalte mănere sunt echipate cu tehnologia patentată ERGONIC. Ele se adaptează formei mâinii utilizatorului și oferă un confort extraordinar al operării.

Szabadalmaztatott ERGONIC markolat a tökéletes kényelemért!  
Biztonságos dugókulcs tartás a rögzítő gomb segítségével



Mecanismul clichetului extrem de puternic, poate prelua forțe de până la 100 Nm și are o dantură super fină cu 72 de dinți și un unghi de clichet de numai 5%.

Extra erős racsniszerkezet szuper finomságú fogaskerékkel (>100Nm, 72 fog, csak 5° hajtási szög)





felo  
Innovations



## 057



	Item No		EAN-Code
<b>R-GO XL</b>	<b>Box, 36-pcs. / Satz 36-tlg.</b>	<b>057 836 16</b>	955 40 07157 61547 3
	<b>ERGONIC Ratchet 1/4" / ERGONIC Ratsche 1/4"</b>		
	<b>ERGONIC Stubby 1/4" / ERGONIC Stubby 1/4"</b>		
[13 x ]	<b>Sockets / Steckschlüsseinsätze</b>		
	4 / 4,5 / 5 / 5,5 / 6 / 7 / 8 / 9 / 10 / 11 / 12 / 13 / 14 mm		
[15 x ]	<b>Bits (C6,3 x 25 mm)</b>		
	4,5 x 0,6 / 5,5 x 1,0		
	4 / 5 / 6 mm		
	PH 1 / 2 / 3		
	PZ 1 / 2		
	Torx® 10 / 15 / 20 / 25 / 30		
	<b>Extension / Verlängerung (100 mm) 1/4" - 1/4"</b>		
	<b>Extension / Verlängerung (50 mm) 1/4" - 1/4"</b>		
	<b>U-Joint / Kardangelenk 1/4"</b>		
	<b>Bitholder / Bithalter E6,3 x 58 mm</b>		
	<b>Adapter / Adapter E 6,3 - 1/4" (50 mm)</b>		
	<b>Adapter / Adapter 1/4" SQ - 1/4" Hex</b>		
	<b>StrongBox 230 x 130 x 56 mm</b>		



**felo**  
Innovations

**M-TEC**

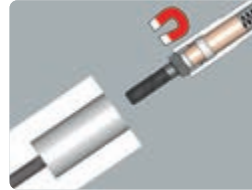

**057**

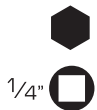

		Item No		EAN-Code
<b>R-GO M-Tec</b>	<b>Box 10-pcs. / Satz 10-tlg.</b>	<b>057 810 06</b>	1050	40 07157 615534
	<b>ERGONIC Ratchet 1/4" / ERGONIC Ratsche 1/4"</b>			
	<b>ERGONIC Screwdriver with 1/4" adapter for sockets /</b> <i>ERGONIC Schraubendreher mit 1/4" Adapter für Steckschlüsseinsätze</i>			
	<b>Nutdrivers / M-Tec Steckschlüssel</b> 5,5 / 6 / 7 / 8 / 10 / 13 mm			
	<b>Extension / Verlängerung (100 mm) 1/4" - 1/4"</b>			
	<b>U-Joint / Kardangelenk 1/4"</b>			
	<b>StrongBox 230 x 130 x 56 mm</b>			



**felo**  
Innovations



**057**



		Item No		EAN-Code
<b>R-GO 19</b>	<b>Box 19-pcs. / Satz 19-tlg.</b>	<b>057 819 06</b>	955	40 07157 61555 8
	<b>ERGONIC Ratchet 1/4" / ERGONIC Ratsche 1/4"</b>			
	<b>ERGONIC Screwdriver with 1/4" adapter for sockets /</b> <i>ERGONIC Schraubendreher mit 1/4" Adapter für Steckschlüsseinsätze</i>			
	<b>Sockets / Steckschlüsseinsätze</b> 4 / 4,5 / 5 / 5,5 / 6 / 7 / 8 / 9 / 10 / 11 / 12 / 13 / 14 mm			
	<b>Extension / Verlängerung (100 mm) 1/4" - 1/4"</b>			
	<b>Extension / Verlängerung (50 mm) 1/4" - 1/4"</b>			
	<b>U-Joint / Kardangelenk 1/4"</b>			
	<b>Adapter / Adapter E 6,3 - 1/4" (50 mm)</b>			
	<b>StrongBox 230 x 130 x 56 mm</b>			



felo  
Innovations



## 057



		Item No		EAN-Code
<b>R-GO 27 Inch/metric</b>	<b>Box 27-pcs. / Satz 27-tlg.</b>	<b>057 827 06</b>	1060	41 07157 62371 3
	<b>ERGONIC Ratchet 1/4" / ERGONIC Ratsche 1/4"</b>			
	<b>ERGONIC Screwdriver with 1/4" adapter for sockets /</b> <i>ERGONIC Schraubendreher mit 1/4" Adapter für Steckschlüsseinsätze</i>			
(21 x )	<b>Sockets / Steckschlüsseinsätze</b> 4 / 4,5 / 5 / 5,5 / 6 / 7 / 8 / 9 / 10 / 11 / 12 / 13 / 14 mm 3/16"   7/32"   1/4"   9/32"   5/16"   3/8"   7/16"   1/2"			
	<b>Extension / Verlängerung (100 mm) 1/4" - 1/4"</b>			
	<b>Extension / Verlängerung (50 mm) 1/4" - 1/4"</b>			
	<b>U-Joint / Kardangelenk 1/4"</b>			
	<b>Adapter / Adapter E 6,3 - 1/4" (50 mm)</b>			
	<b>StrongBox 230 x 130 x 56 mm</b>			



**felo**  
Innovations



**057**



	Item No		EAN-Code
<b>R-GO 36 Box 36-pcs. / Satz 36-tlg.</b>	<b>057 836 06</b>	900	4007157 61557 2
<b>ERGONIC Ratchet 1/4" / ERGONIC Ratsche 1/4"</b>			
<b>ERGONIC 438 Screwdriver with Bitholder / ERGONIC 438 Schraubendreher mit Bithalter</b>			
(30 x) <b>Bits (C6,3 x 25 mm)</b>			
3,0 x 0,5 / 4,5 x 0,6 / 5,5 x 1,0 / 6,5 x 1,2			
2 mm / 3 mm / 4 mm / 5 mm / 6 mm			
PH 0 / PH 1 / PH 2 / PH 3			
PZ 1 / PZ 2 / PZ 3			
Torx® 5 / Torx® 6 / Torx® 7 / Torx® 8 / Torx® 10 / Torx® 15 / Torx® 20 / Torx® 25 / Torx® 30 / Torx® 40			
SQ 1 / SQ 2			
Spanner 6 / Spanner 8			
<b>Extension (100 mm) 1/4" - 1/4" / Verlängerung</b>			
<b>Extension (50 mm) 1/4" - 1/4" / Verlängerung</b>			
<b>Bitholder E6,3 x 58 mm / Bithalter</b>			
<b>Adapter 1/4" SQ - 1/4" Hex / Adapter</b>			
<b>StrongBox 230 x 130 x 56 mm</b>			



felo  
Innovations



## 057



	Item No		EAN-Code
<b>R-GO XL Inch</b> <b>36-pcs. / Satz 36-tlg.</b>	<b>057 836 56</b>	955	40 07157 62053 8
	<b>ERGONIC Ratchet 1/4" / ERGONIC Ratsche 1/4"</b>		
	<b>ERGONIC Stubby 1/4" / ERGONIC Stubby 1/4"</b>		
[13 x]	<b>Sockets / Steckschlüsseleinsätze</b>		
	1/8"   9/64"   5/32"   3/16"   7/32"   1/4"   9/32"   5/16"   11/32"   3/8"   7/16"   1/2"   9/16"		
[15 x]	<b>Bits (C6,3 x 25 mm)</b>		
	4,5 x 0,6 / 5,5 x 1,0		
	PH 1/ 2 / 3		
	Torx® 8 / 10 / 15 / 20 / 25 / 30		
	SQ 0 (1,75 mm) / 1 (2,30 mm) / 2 (2,80 mm) / 3 (3,30 mm)		
	<b>Extension / Verlängerung (100 mm) 1/4" - 1/4"</b>		
	<b>Extension / Verlängerung (50 mm) 1/4" - 1/4"</b>		
	<b>U-Joint / Kardangelenk 1/4"</b>		
	<b>Bitholder / Bithalter E6,3 x 58 mm</b>		
	<b>Adapter / Adapter E 6,3 - 1/4" (50 mm)</b>		
	<b>Adapter / Adapter 1/4" SQ - 1/4" Hex</b>		
	<b>StrongBox 230 x 130 x 56 mm</b>		



**felo**  
Innovations



**057**



		Item No		EAN-Code
<b>R-GO 19 Inch</b>	<b>Box 19-pcs. / Satz 19-tlg.</b>	<b>057 819 56</b>	955	40 07157 62055 2
	<b>ERGONIC Ratchet 1/4" / ERGONIC Ratsche 1/4"</b>			
	<b>ERGONIC Screwdriver with 1/4" adapter for sockets /</b> <i>ERGONIC Schraubendreher mit 1/4" Adapter für Steckschlüsseinsätze</i>			
	<b>Sockets / Steckschlüsseinsätze</b> (13 x)			
	1/8"   9/64"   5/32"   3/16"   7/32"   1/4"   9/32"   5/16"   11/32"   3/8"   7/16"   1/2"   9/16"			
	<b>Extension / Verlängerung</b> (100 mm) 1/4" - 1/4"			
	<b>Extension / Verlängerung</b> (50 mm) 1/4" - 1/4"			
	<b>U-Joint / Kardangelenk</b> 1/4"			
	<b>Adapter / Adapter</b> E 6,3 - 1/4" (50 mm)			
	<b>StrongBox</b> 230 x 130 x 56 mm			



**felo**  
Innovations



**497**

		Item No		EAN-Code
	<b>ERGONIC Ratchet 1/4" in Blister/</b> <i>ERGONIC Ratsche 1/4" auf Karte</i>	<b>497 635 41</b>	128	40 07157 61481 0



**felo**  
Innovations



**096**



				Item No		EAN-Code
<b>Nutdriver M-TEC / Steckschlüssel M-TEC</b>						
<b>5,5mm</b>	86	1/4"	1	<b>096 055 20</b>	31	40 07157 61713 2
<b>6mm</b>	86	1/4"	1	<b>096 060 20</b>	33	40 07157 61715 6
<b>7mm</b>	86	1/4"	1	<b>096 070 20</b>	41	40 07157 61717 0
<b>8mm</b>	86	1/4"	1	<b>096 080 20</b>	45	40 07157 61719 4
<b>10mm</b>	103	1/4"	1	<b>096 100 20</b>	57	40 07157 61721 7
<b>13mm</b>	103	1/4"	1	<b>096 130 20</b>	114	40 07157 61723 1



**Mecanism clichet super rezistent cu dantură super fină (>65Nm, 60 dinți, 6° unghi clichet).**

*Extra erős racsniszerkezet szuper finomságú fogaskerékkel (>65Nm, 60 fog, 6° hajtási szög)*

**Insertie directă pentru biți=înălțime de operare extrem de mică.**

*A bit közvetlenül rögzíthető, így extra alacsony területen is használható*



**Mănerul în unghi face munca mult mai confortabilă și protejează degetele**

*A kissé hajlított markolat kényelmesebbé teszi a munkát és védi az ujjakat.*

## XS

**Seturi de buzunar construite pentru munca dură în spații înguste**

*Zsebrevágható szerszámkészletek, szűk helyeken végzett kemény munkához.*



**Clichetul e forjat dintr-o singură bucată de oțel crom-vanadium.**

*A racsniszerkezet egy darabban kovacsolt króm-vanádium acélból készült.*

**Compoziții orientate pe meserii, depozitate în cutiile robuste și rezistente la umezeală StrongBox**

*A legfontosabb szerszámok egy kisméretű, de extra erős tárolódobozban.*

**Calitate premium cu o durată lungă de viață, în fiecare detaliu: 15 ani garanție pentru fiecare componentă**

*Hosszan tartó prémium szerszámok, minden alkatrészére 15 év garancia!*







057



		Item No		EAN-Code
<b>XS 11</b>	<b>11-pcs. / Satz 11-tlg.</b>	<b>057 711 06</b>	410	40 07157 61559 6
	<b>Mini Ratchet 1/4" / Miniratsche 1/4"</b>			
(7 x )	<b>Sockets / Steckschlüsseleinsätze</b>			
	5,5 / 6 / 7 / 8 / 10 / 11 / 13 mm			
	<b>Extension / Verlängerung (100 mm) 1/4" - 1/4"</b>			
	<b>Adapter / Adapter E 6,3 - 1/4" (50 mm)</b>			
	<b>Adapter / Adapter C 6,3 - 1/4" (25 mm)</b>			
	<b>StrongBox</b> 135 x 75 x 37 mm			



057



		Item No		EAN-Code
<b>XS 18</b>	<b>18-pcs. / Satz 18-tlg.</b>	<b>057 718 06</b>	420	40 07157 61561 9
	<b>Mini Ratchet 1/4" / Miniratsche 1/4"</b>			
(7 x )	<b>Sockets / Steckschlüsseleinsätze</b>			
	5 / 5,5 / 6 / 7 / 8 / 10 / 13 mm			
(7 x )	<b>Bits (C6,3 x 25mm)</b>			
	4,5 x 0,6 / 5,5 x 0,8 / 6,5 x 1,2			
	PH 1 / PH 2 / PH 3			
	PZ 2			
	<b>Extension / Verlängerung (50 mm) 1/4" - 1/4"</b>			
	<b>Adapter / Adapter C 6,3 - 1/4" (25 mm)</b>			
	<b>Bitholder / Bithalter E6,3 x 58 mm</b>			
	<b>StrongBox</b> 135 x 75 x 37 mm			



felo  
Innovations



## 057



	Item No		EAN-Code
<b>XS 33</b>	<b>33-pcs. / Satz 33-tlg.</b>		
	<b>057 733 06</b>	425	40 07157 61545 9
	<b>Mini Ratchet 1/4" / Miniratsche 1/4"</b>		
(30 x )	<b>Bits (C6,3 x 25 mm)</b>		
	3,0 x 0,5 / 5,0 x 0,8 / 6,5 x 1,2		
	2 / 2,5 / 3 / 4 / 5 / 6 / 8 mm		
	PH 0 / PH 1 / 2x PH 2 / PH 3		
	PZ 1 / 2x PZ 2 / PZ 3		
	Torx® 6 / Torx® 7 / Torx® 8 / Torx® 9		
	Torx® TR 10 / Torx® TR 15 / Torx® TR 20 / Torx® TR 25 / Torx® TR 27 / Torx® TR 30 / Torx® TR 40		
	<b>Adapter / Adapter C 6,3 - 1/4" (25 mm)</b>		
	<b>Bitholder / Bithalter E6,3 x 58 mm</b>		
	<b>StrongBox 135 x 75 x 37 mm</b>		

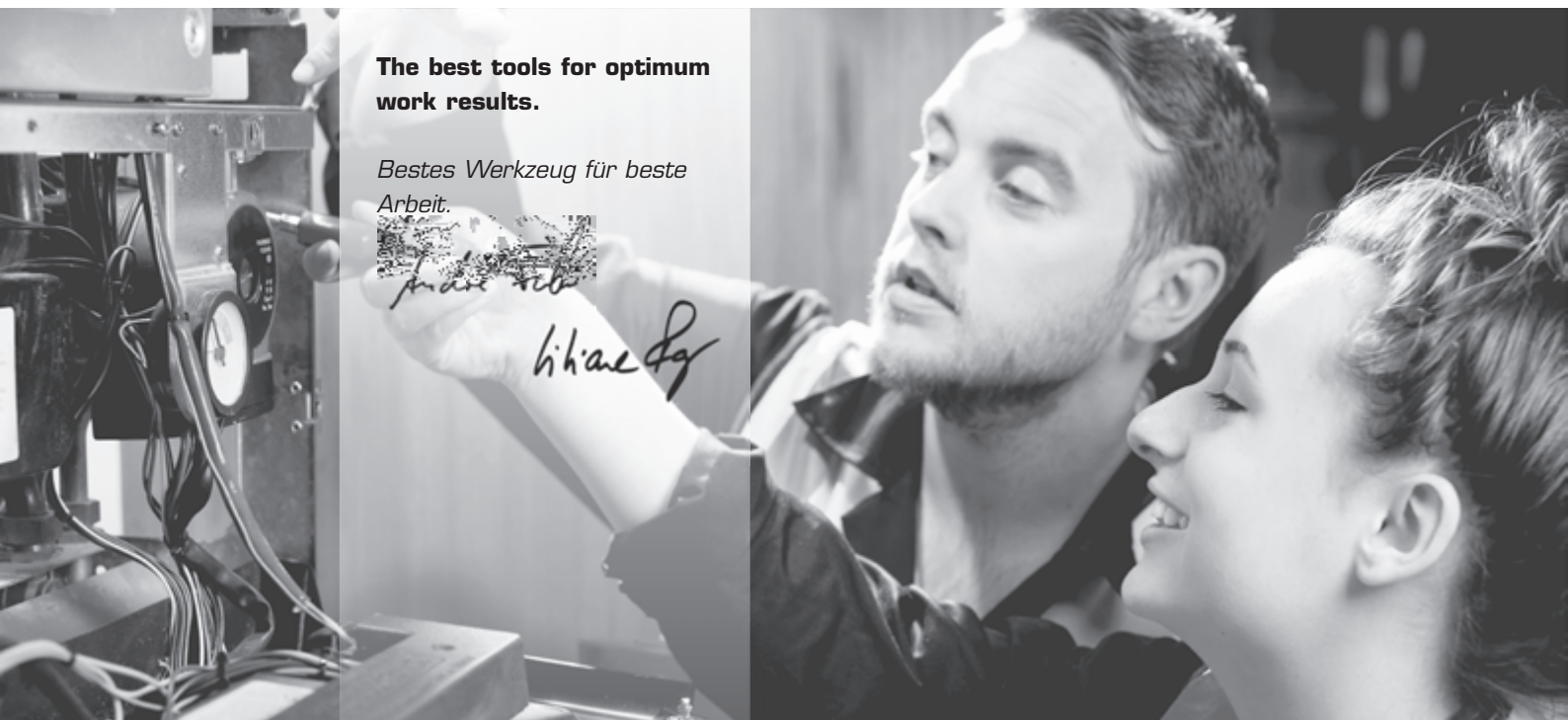

**The best tools for optimum work results.**

*Bestes Werkzeug für beste Arbeit.*

*Andreas Reib*

*hikae lg*



**felo**  
Innovations



**057**



		Item No		EAN-Code
<b>XS 11 Inch</b>	<b>11-pcs. / Satz 11-tlg.</b>	<b>057 711 56</b>	410	40 07157 62057 6
	<b>Mini Ratchet 1/4" / Miniratsche 1/4"</b>			
(7 x)	<b>Sockets / Steckschlüsseleinsätze</b>			
	3/16"   7/32"   1/4"   9/32"   5/16"   3/8"   1/2"			
	<b>Extension / Verlängerung (100 mm) 1/4" - 1/4"</b>			
	<b>Adapter / Adapter E 6,3 - 1/4" (50 mm)</b>			
	<b>Adapter / Adapter C 6,3 - 1/4" (25 mm)</b>			
	<b>StrongBox 135 x 75 x 37 mm</b>			



**felo**  
Innovations



**057**



		Item No		EAN-Code
<b>XS 18 Inch</b>	<b>18-pcs. / Satz 18-tlg.</b>	<b>057 718 56</b>	420	40 07157 62059 0
	<b>Mini Ratchet 1/4" / Miniratsche 1/4"</b>			
(7 x)	<b>Sockets / Steckschlüsseleinsätze</b>			
	3/16"   7/32"   1/4"   9/32"   5/16"   3/8"   1/2"			
(7 x)	<b>Bits (C6,3 x 25mm)</b>			
	4,5 x 0,6 / 5,5 x 0,8 / 6,5 x 1,2			
	PH 1 / PH 2 / PH 3			
	SQ 2			
	<b>Extension / Verlängerung (50 mm) 1/4" - 1/4"</b>			
	<b>Adapter / Adapter C 6,3 - 1/4" (25 mm)</b>			
	<b>Bitholder / Bithalter E6,3 x 58 mm</b>			
	<b>StrongBox 135 x 75 x 37 mm</b>			



felo  
Innovations



057



**Mini Ratchet 1/4" with Adapter C 6,3 - 1/4" in blister**

Item No

**057 635 01**



118

EAN-Code

40 07157 61569 5

*Miniratsche 1/4" mit Adapter C 6,3 - 1/4" auf Karte*



felo  
Innovations

438



**ERGONIC Stubby Handle 1/4"**



61



25



1

Item No

**438 025 40**



32

EAN-Code

40 07157 61585 5

*ERGONIC Stubby Griff 1/4"*



389

Item No

**389 800 01**



100

EAN-Code

40 07157 61733 0

**Belt-Pouch for XS StrongBox (in blister)**

*Gürteltasche für XS Strongbox (in Blister)*



097



**Extension / Verlängerung**



50mm



1/4"



1

Item No

**097 050 10**



22

EAN-Code

40 07157 61683 8

100mm

1/4"

1

**097 100 10**

43

40 07157 61681 4

# 097



1/4" ■

				Item No		EAN-Code
<b>U-Joint 1/4"</b>			1	<b>097 000 10</b>	22	40 07157 61729 3
<i>Kardangelenk 1/4"</i>						

# 097



1/4" □

					Item No		EAN-Code
<b>Adapter</b>	25 mm	1/4"	C 6,3	1	<b>097 019 10</b>	25	40 07157 61685 2

# 096



mm				Item No		EAN-Code
<b>4</b>	25	1/4"	1	<b>096 040 10</b>	10	40 07157 61687 6
<b>4,5</b>	25	1/4"	1	<b>096 045 10</b>	10	40 07157 61689 0
<b>5</b>	25	1/4"	1	<b>096 050 10</b>	10	40 07157 61691 3
<b>5,5</b>	25	1/4"	1	<b>096 055 10</b>	10	40 07157 61693 7
<b>6</b>	25	1/4"	1	<b>096 060 10</b>	11	40 07157 61695 1
<b>7</b>	25	1/4"	1	<b>096 070 10</b>	11	40 07157 61697 5
<b>8</b>	25	1/4"	1	<b>096 080 10</b>	12	40 07157 61699 9
<b>9</b>	25	1/4"	1	<b>096 090 10</b>	12	40 07157 61701 9
<b>10</b>	25	1/4"	1	<b>096 100 10</b>	12	40 07157 61703 3
<b>11</b>	25	1/4"	1	<b>096 110 10</b>	18	40 07157 61705 7
<b>12</b>	25	1/4"	1	<b>096 120 10</b>	21	40 07157 61707 1
<b>13</b>	25	1/4"	1	<b>096 130 10</b>	23	40 07157 61709 5
<b>14</b>	25	1/4"	1	<b>096 140 10</b>	31	40 07157 61711 8

# 096



Inch				Item No		EAN-Code
<b>1/8"</b>	25	1/4"	1	<b>096 200 10</b>	10	40 07157 62757 5
<b>9/64"</b>	25	1/4"	1	<b>096 210 10</b>	10	40 07157 62759 9
<b>5/32"</b>	25	1/4"	1	<b>096 220 10</b>	10	40 07157 62761 2
<b>3/16"</b>	25	1/4"	1	<b>096 230 10</b>	10	40 07157 62763 6
<b>7/32"</b>	25	1/4"	1	<b>096 240 10</b>	11	40 07157 62765 0
<b>1/4"</b>	25	1/4"	1	<b>096 250 10</b>	11	40 07157 62767 4
<b>9/32"</b>	25	1/4"	1	<b>096 260 10</b>	12	40 07157 62769 8
<b>5/16"</b>	25	1/4"	1	<b>096 270 10</b>	12	40 07157 62771 1
<b>11/32"</b>	25	1/4"	1	<b>096 280 10</b>	12	40 07157 62773 5
<b>3/8"</b>	25	1/4"	1	<b>096 290 10</b>	18	40 07157 62775 9
<b>7/16"</b>	25	1/4"	1	<b>096 300 10</b>	21	40 07157 62777 3
<b>1/2"</b>	25	1/4"	1	<b>096 310 10</b>	23	40 07157 62779 7
<b>9/16"</b>	25	1/4"	1	<b>096 320 10</b>	31	40 07157 62781 0

**Mâner bi-component cu material exterior soft-grip pentru torsiune superioară**

*kétkomponensű markolat, puha borítással a még nagyobb nyomatékért*

## SMART

**Șurubelniță și mâner în T într-un singur produs**  
*Csavarhúzó és T-kulcs egyben*



**Design ergonomic rafinat**

*ergonomikus, kifinomult kialakítás*

**Înlocuiește 48 de scule de mână**

*48 féle felhasználási lehetőség*

**Lame făcute din oțel de biți de înaltă calitate ce depășesc norme DIN/ISO cu până la 100%**

*a pengék anyaga több mint 100%-kal meghaladja az ISO és DIN szabványok követelményeit*

**Design mâner anti-roll**

*gurulásmentes markolat kialakítás*

**Se potrivește cu întreaga gamă 1/4"**

*Beleillik a teljes 1/4" bit pengeválaszték*

**Vârf negru pentru precizie**

*bevonatmentes végződés a pontos illesztésért*



**Un set complet de scule de 48 de bucăți într-o singură cutie!  
Fiecare lama este mașinată precis,  
perfect întărită termic și așezată  
convenabil în set pentru a fi accesată  
foarte ușor.**

*48 féle szerszám felhasználási lehetőség  
egy dobozban, melyben biztonságosan  
tárolhatja, és könnyedén kiválaszthatja  
a használni kívánt szerszámot.*

## **Calitate profesională și versatilitate fără egal** *Professzionális minőség és sokoldalúság*

**SMART este un sistem de lame interschimbabile unic ce conține un mâner pivotant bi-component ce poate fi folosit și ca șurubelniță normală și ca șurubelniță cu mâner în T**

*A SMART készlet az egyedülálló kétkomponenses markolattal és a cserélhető pengékkel együtt csavarhúzóként és T-markolatú szerszámként is használható.*

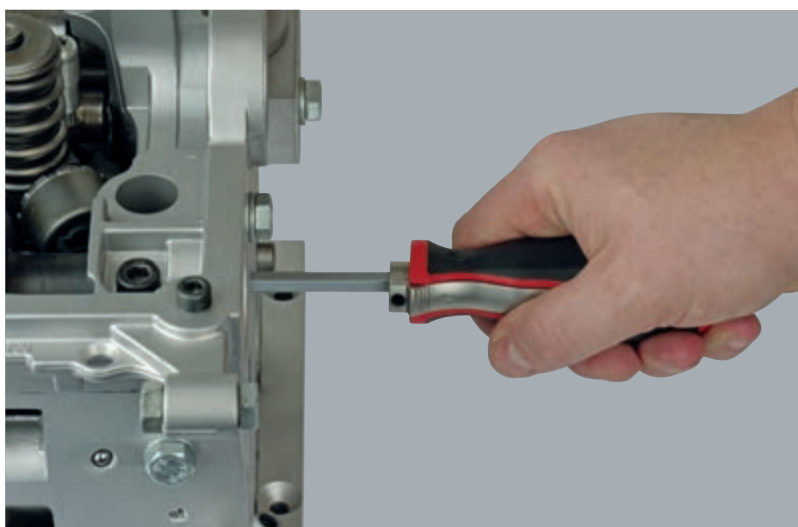

**Noul design îmbunătățit ne permite utilizarea facilă cu o singură mână: nu trebuie scoasă lama la transformarea din mâner normal în mâner în T!**

*Az új fejlesztésű markolat lehetővé teszi a szerszám egykezes átalakítását csavarhúzóból T-markolatú a penge eltávolítása nélkül.*



**felo**  
Innovations



**felo**  
Innovations



## 060



		Item No		EAN-Code
<b>Felo-SMART</b>	<b>Box 13-pcs. / Satz 13-tlg.</b>	<b>060 813 06</b>	1090	40 07157 60413 2
(12 x )	<b>Blade / Klinge</b> 1/4" x 160 mm			
	PZ 1 - 5,0 / PZ 2 - 6,0 / PZ 3 - 7,0 / PH 1 - 4,0 / PH 2 - PH 3			
	3 mm - 4 mm / 5 mm - 6 mm /			
	Torx® 6 - Torx® 7 / Torx® 8 - Torx® 9 / Torx® 10 - Torx® 15 / Torx® 20 - Torx® 25 / Torx® 30 - Torx® 40			
	<b>Handle / Griff</b> 105 x 39 mm			
	<b>StrongBox</b> 230 x 130 x 56 mm			



**felo**  
Innovations



## 060



		Item No		EAN-Code
<b>Felo-SMART belt pouch / Gürteltasche</b>	<b>Pouch 9-pcs. / Gürteltasche 9-tlg.</b>	<b>060 809 04</b>	566	40 07157 60425 5
(8 x )	<b>Blade / Klinge</b>			
	PZ 1 - 5,0 / PZ 2 - 6,0 / PZ 3 - 7,0			
	PH 1 - 4,0 / PH 2 - PH 3			
	5 mm - 6 mm			
	Torx® 20 - Torx® 25 / Torx® 30 - Torx® 40			
	<b>Handle / Griff</b> 105 x 39 mm			
	<b>Nylon Pouch / Nylon Tasche</b>			





**felo**  
Innovations

060



		Item No		EAN-Code
<b>Felo-SMART II</b>	<b>Box 29-pcs. / Satz 29-tlg.</b>	<b>060 815 06</b>	985	40 07157 60415 6
[16 x ]	<b>Bits C 6,3 x 25 mm</b>			
	PZ 1 / PZ 2 / PZ 3 / PH 1 / PH 2 / PH 3			
	5 mm / 6 mm / 3,5 x 0,6 / 5,0 x 0,8 / 6,5 x 1,2			
	Torx® 15 / Torx® 20 / Torx® 25 / Torx® 30 / Torx® 40			
	<b>Bit Holder with Quick-Release Chuck / Bit Schnellwechselfutter</b>			
[7 x ]	<b>Socket / Steckschlüssel</b>			
	4 / 5 / 5,5 / 6 / 8 / 10 / 13 mm			
	<b>Adapter / Adapter 1/4" - C 6,3 (Art.No. 097 018 10)</b>			
	<b>Extension / Verlängerung, 1/4" - E 6,3 (Art.No. 097 150 14)</b>			
	<b>Extension for Sockets / Verlängerung für Steckschlüssel 75 mm</b>			
	<b>Ergonic Ratchet / Ergonic Ratsche 1/4"</b>			
	<b>Handle / Griff 105 x 39 mm</b>			
	<b>StrongBox 230 x 130 x 56 mm</b>			

**Compact, without  
compromises in quality  
and function.**

*Kompakt, ohne Kompromiss  
bei Qualität oder Funktion.*

*Kla. Polk*

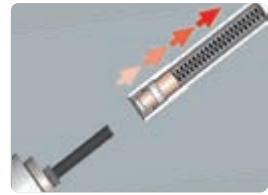
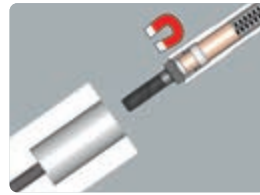

## M-TEC



**felo**  
Innovations

**060**



		Item No		EAN-Code
<b>Felo-SMART Engineer</b>	<b>Box 20-pcs. / Satz 20-tlg.</b>	<b>060 820 06</b>	1218	40 07157 60421 7
(7 x)	<b>M-Tec 1/4"</b>			
	5,5 mm x 116 mm / 6 mm x 116 mm / 7 mm x 116 mm / 8 mm x 116 mm			
	10 mm x 133 mm / 13 mm x 133 mm			
	17 x 158 mm			
	<b>Bitholder / Bithalter 1/4" x 47 mm</b>			
	<b>Bitholder / Bithalter 1/4" x 155 mm</b>			
(10 x)	<b>Bits C 6,3 x 25 mm</b>			
	PZ 1 / 2 / PH 1 / 2			
	3,5 x 0,6 / 5,0 x 0,8			
	Torx® 15 / Torx® 20 / Torx® 25 / Torx® 30			
	<b>Handle / Griff 105 x 39 mm</b>			
	<b>StrongBox 230 x 130 x 56 mm</b>			



**felo**  
Innovations

**060**



	Item No		EAN-Code
<b>Felo-SMART Engineer Inch Version / Zoll Version</b>	<b>060 920 36</b>	1286	40 07157 52953 4
<b>Box 20-pcs. / Satz 20-tlg.</b>			
(8 x ) <b>Socket / Steckschlüssel E 6,3 x 155</b>			
7/32" 1/4" 9/32" 5/16" 3/8" 7/16" 1/2" 9/16"			
<b>Bitholder / Bithalter 1/4"</b>			
(10 x ) <b>Bits C 6,3 x 25 mm</b>			
PZ 1 / 2 / PH1 / 2 /			
3,5 x 0,6 / 5,0 x 0,8			
Torx® 15 / 20 / 25 / 30			
<b>Handle / Griff 105 x 39 mm</b>			
<b>Metal Case / Stahlblechbox 220 x 110 x 35 mm</b>			

**069**



**felo**  
Innovations



	Item No		EAN-Code
<b>SMART-Handle / SMART-Griff</b>	<b>069 205 00</b>	105	40 07157 60427 9

**389**



	Item No		EAN-Code
<b>Nylon Pouch / Nylon Tasche</b>	<b>389 900 00</b>	80	40 07157 50456 2

## 068



				Item No		EAN-Code
<b>5,5 mm</b>	155 mm	E 6,3 / 1/4"	1	<b>068 055 04</b>	52	40 07157 52709 7
<b>6 mm</b>	155 mm	E 6,3 / 1/4"	1	<b>068 060 04</b>	52	40 07157 52711 0
<b>7 mm</b>	155 mm	E 6,3 / 1/4"	1	<b>068 070 04</b>	57	40 07157 50302 2
<b>8 mm</b>	155 mm	E 6,3 / 1/4"	1	<b>068 080 04</b>	60	40 07157 50304 6
<b>10 mm</b>	155 mm	E 6,3 / 1/4"	1	<b>068 100 04</b>	64	40 07157 50306 0
<b>11 mm</b>	155 mm	E 6,3 / 1/4"	1	<b>068 110 04</b>	73	40 07157 52713 4
<b>13 mm</b>	155 mm	E 6,3 / 1/4"	1	<b>068 130 04</b>	76	40 07157 50308 4
<b>17 mm</b>	155 mm	E 6,3 / 1/4"	1	<b>068 170 04</b>	102	40 07157 52715 8

## 068



				Item No		EAN-Code
<b>7/32"</b>	155 mm	E 6,3 / 1/4"	1	<b>068 555 04</b>	51	40 07157 53195 7
<b>1/4"</b>	155 mm	E 6,3 / 1/4"	1	<b>068 635 04</b>	52	40 07157 53197 1
<b>9/32"</b>	155 mm	E 6,3 / 1/4"	1	<b>068 714 04</b>	57	40 07157 53199 5
<b>5/16"</b>	155 mm	E 6,3 / 1/4"	1	<b>068 793 04</b>	59	40 07157 53201 5
<b>3/8"</b>	155 mm	E 6,3 / 1/4"	1	<b>068 952 04</b>	64	40 07157 53203 9
<b>7/16"</b>	155 mm	E 6,3 / 1/4"	1	<b>068 111 04</b>	72	40 07157 53205 3
<b>1/2"</b>	155 mm	E 6,3 / 1/4"	1	<b>068 127 04</b>	77	40 07157 53207 7
<b>9/16"</b>	155 mm	E 6,3 / 1/4"	1	<b>068 142 04</b>	77	40 07157 53209 1



				Item No		EAN-Code
<b>PH 1 - 4,0 x 0,8</b>	160 mm	1/4"	1	<b>062 104 04</b>	42	40 07157 32116 9
<b>PH 1 - 7,0 x 1,2</b>	160 mm	1/4"	1	<b>062 107 04</b>	43	40 07157 50312 1
<b>PH 2 - PH 3</b>	160 mm	1/4"	1	<b>062 023 04</b>	44	40 07157 32118 3
<b>PH 2 - 6,0 x 1,0</b>	160 mm	1/4"	1	<b>062 206 04</b>	41	40 07157 50310 7
<b>PZ 1 - 5,0 x 0,8</b>	160 mm	1/4"	1	<b>061 105 04</b>	42	40 07157 32110 7
<b>PZ 2 - 6,0 x 1,0</b>	160 mm	1/4"	1	<b>061 206 04</b>	43	40 07157 32112 1
<b>PZ 3 - 7,0 x 1,2</b>	160 mm	1/4"	1	<b>061 307 04</b>	44	40 07157 32114 5
<b>3 mm - 4 mm</b>	160 mm	1/4"	1	<b>064 034 04</b>	44	40 07157 32106 0
<b>5 mm - 6 mm</b>	160 mm	1/4"	1	<b>064 056 04</b>	45	40 07157 32130 5
<b>Torx® 06 - Torx® 07</b>	160 mm	1/4"	1	<b>066 067 04</b>	42	40 07157 32096 4
<b>Torx® 08 - Torx® 09</b>	160 mm	1/4"	1	<b>066 089 04</b>	41	40 07157 32098 8
<b>Torx® 10 - Torx® 15</b>	160 mm	1/4"	1	<b>066 115 04</b>	41	40 07157 32100 8
<b>Torx® 20 - Torx® 25</b>	160 mm	1/4"	1	<b>066 225 04</b>	42	40 07157 32102 2
<b>Torx® 30 - Torx® 40</b>	160 mm	1/4"	1	<b>066 340 04</b>	45	40 07157 32104 6
<b>SQ 0 - SQ 1</b>	160 mm	1/4"	1	<b>065 001 04</b>	46	40 07157 50346 6
<b>SQ 2 - SQ 3</b>	160 mm	1/4"	1	<b>065 023 04</b>	48	40 07157 50348 0
<b>Torx®TR 10 - Torx®TR 15</b>	160 mm	1/4"	1	<b>067 115 04</b>	46	40 07157 32120 6
<b>Torx®TR 20 - Torx®TR 25</b>	160 mm	1/4"	1	<b>067 225 04</b>	46	40 07157 32122 0
<b>Torx®TR 30 - Torx®TR 45</b>	160 mm	1/4"	1	<b>067 340 04</b>	48	40 07157 32124 4



**felo**  
Innovations



## 068



				Item No		EAN-Code
<b>5,5 mm</b>	116 mm	1/4"	1	<b>068 055 24</b>	50	40 07157 60541 2
<b>6,0 mm</b>	116 mm	1/4"	1	<b>068 060 24</b>	66	40 07157 60543 6
<b>7,0 mm</b>	116 mm	1/4"	1	<b>068 070 24</b>	69	40 07157 60545 0
<b>8,0 mm</b>	116 mm	1/4"	1	<b>068 080 24</b>	72	40 07157 60547 4
<b>10,0 mm</b>	133 mm	1/4"	1	<b>068 100 24</b>	87	40 07157 60549 8
<b>13,0 mm</b>	133 mm	1/4"	1	<b>068 130 24</b>	137	40 07157 60551 1
<b>17,0 mm</b>	158 mm	1/4"	1	<b>068 170 24</b>	217	40 07157 60553 5



				Item No		EAN-Code
<b>Adapter</b>	150 mm	E 6,3 / 1/4"	1	<b>097 150 14</b>	62	40 07157 32128 2
<b>Bitholder / Bithalter</b>	155 mm	1/4"	1	<b>068 635 14</b>	62	40 07157 53179 7



## 4 IMPACT

**Cu cascadă unică de absorbție a șocurilor pentru cea mai bună protecție și cea mai lungă durată de viață chiar și la cele mai dure șocuri!**

*Az egyedülálló terhelést csökkentő rendszerrel, a legjobb védelem és a lehető leghosszabb élettartam érdekében, még dinamikus terhelésnél is!*

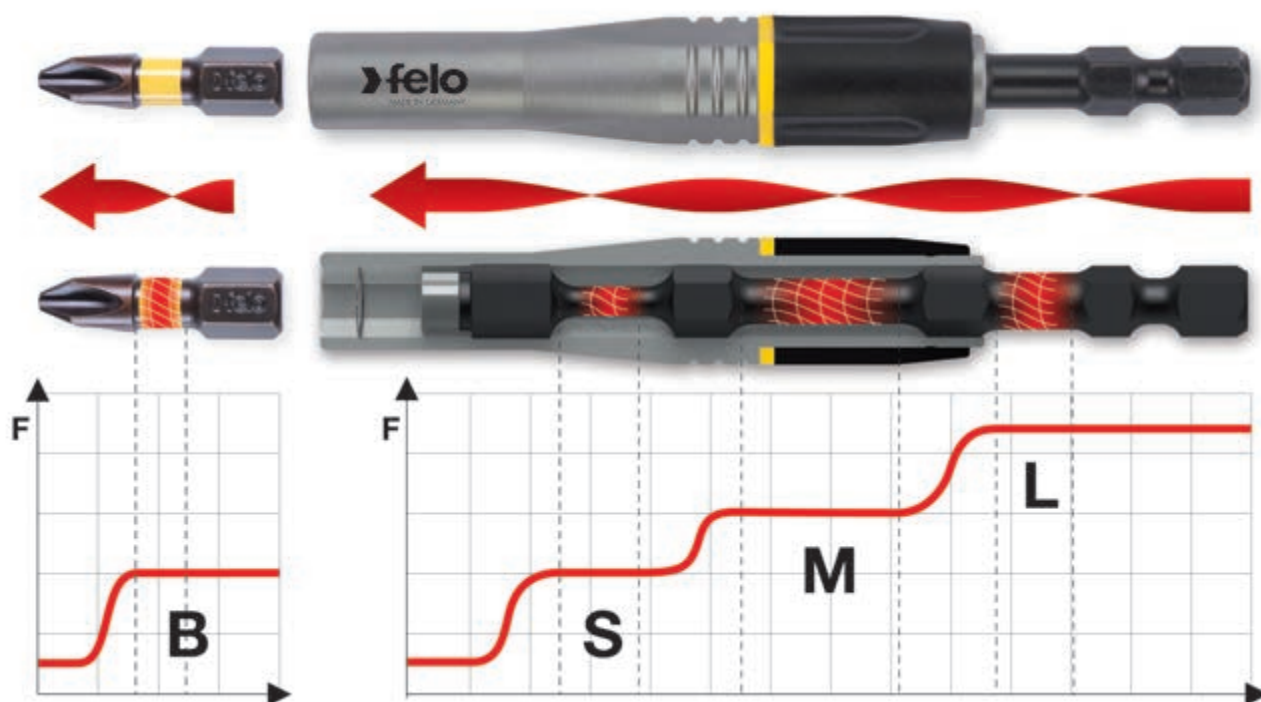

## 4 IMPACT

- cascadă absorbție șocuri S-M-L pentru o gamă variată de torziuni (e.g. PH1 – PH3).
- Zonele sincronizate de torsiune sunt declanșate secvențial de către impulsurile crescute de torsiune și absorb vârfurile de torsiune.
- O a patra zonă adițională de absorbție a șocurilor, când este folosit cu biții Felo IMPACT.
- Conceput special pentru a fi folosit cu mașinile de impact tangențiale.
- Cu inel rotativ

## 4 IMPACT

- S-M-L terhelést csökkentő rendszer széles nyomatéktartományhoz (pl: PH1-PH3).
- A szinkronizált torziós-zónák egymásután indulnak, növelve a nyomatékimpulzusokat és elnyelve a hirtelen nyomatéknövekedést.
- A folyamat negyedik lépése lehet, ha a terhelést csökkentő FELO IMPACT biteket használja
- Speciálisan ütvecsavarozókhoz fejlesztett bittartó
- Megtartó gyűrűvel.

**038**  
**E 6,3**



See also page 168 /  
siehe auch Seite 168



				Item No		EAN-Code
<b>Bitholder IMPACT 1/4" / Bithalter IMPACT 1/4"</b>	95 mm	E 6,3	6	<b>038 295 90</b>	43	40 07157 63337 8

**038**  
**E 6,3**



See also page 168 /  
siehe auch Seite 168



			Item No		EAN-Code
<b>Bitholder IMPACT 1/4" on Card / Bithalter IMPACT a.K.</b>	95 mm	E 6,3	<b>038 295 94</b>	53	40 07157 63077 3

**020**



		Item No		EAN-Code
<b>Bit-Tool IMPACT on blister / in Blister</b> C 6,3 x 25 mm	10	<b>020 802 46</b>	193	40 07157 63429 0
<b>8 Bits + IMPACT Bitholder+ Bitholder / IMPACT Bithalter + Magnethalter</b>				
(1 x) <b>026:</b>		Torx® 10		
(1 x) <b>026:</b>		Torx® 15		
(1 x) <b>026:</b>		Torx® 20		
(2 x) <b>026:</b>		Torx® 25		
(2 x) <b>026:</b>		Torx® 30		
(1 x) <b>026:</b>		Torx® 40		
(1 x) <b>038:</b>		<b>IMPACT Bitholder / Impact Bithalter</b>		
(1 x) <b>038:</b>		<b>Bitholder / Magnethalter (58 mm)</b>		

## 021 C 6,3



IMPACT PZ					Item No		EAN-Code
1	25 mm	C 6,3	1/4"	5	<b>021 010 40</b>	3	40 07157 62939 5
2	25 mm	C 6,3	1/4"	5	<b>021 020 40</b>	4	40 07157 62941 8
3	25 mm	C 6,3	1/4"	5	<b>021 030 40</b>	5	40 07157 62943 2

## 022 C 6,3



IMPACT PH					Item No		EAN-Code
1	25 mm	C 6,3	1/4"	5	<b>022 010 40</b>	3	40 07157 62933 3
2	25 mm	C 6,3	1/4"	5	<b>022 020 40</b>	4	40 07157 62935 7
3	25 mm	C 6,3	1/4"	5	<b>022 030 40</b>	5	40 07157 62937 1

## 026 C 6,3



IMPACT Torx®					Item No		EAN-Code
10	25 mm	C 6,3	1/4"	5	<b>026 100 40</b>	3	40 07157 62945 6
15	25 mm	C 6,3	1/4"	5	<b>026 150 40</b>	3	40 07157 62947 0
20	25 mm	C 6,3	1/4"	5	<b>026 200 40</b>	4	40 07157 62949 4
25	25 mm	C 6,3	1/4"	5	<b>026 250 40</b>	4	40 07157 62951 7
30	25 mm	C 6,3	1/4"	5	<b>026 300 40</b>	5	40 07157 62953 1
40	25 mm	C 6,3	1/4"	5	<b>026 400 40</b>	5	40 07157 62955 5

**Felo Tools – always reliable  
and made for the job.**

*Felo Werkzeuge – immer  
zuverlässig und auf die  
Aufgabe abgestimmt.*



**031**  
**E 6,3**



**felo**  
Innovations



IMPACT PZ				Item No		EAN-Code
<b>1</b>	50 mm	E 6,3	1/4" 5	<b>031 015 40</b>	6	40 07157 62963 0
<b>2</b>	50 mm	E 6,3	1/4" 5	<b>031 025 40</b>	7	40 07157 62965 4
<b>3</b>	50 mm	E 6,3	1/4" 5	<b>031 035 40</b>	8	40 07157 62967 8

**032**  
**E 6,3**



**felo**  
Innovations



IMPACT PH				Item No		EAN-Code
<b>1</b>	50 mm	E 6,3	1/4" 5	<b>032 015 40</b>	6	40 07157 62957 9
<b>2</b>	50 mm	E 6,3	1/4" 5	<b>032 025 40</b>	7	40 07157 62959 3
<b>3</b>	50 mm	E 6,3	1/4" 5	<b>032 035 40</b>	8	40 07157 62961 6

**036**  
**E 6,3**



**felo**  
Innovations



IMPACT Torx®				Item No		EAN-Code
<b>10</b>	50 mm	E 6,3	1/4" 5	<b>036 105 40</b>	8	40 07157 62969 2
<b>15</b>	50 mm	E 6,3	1/4" 5	<b>036 155 40</b>	8	40 07157 62971 5
<b>20</b>	50 mm	E 6,3	1/4" 5	<b>036 205 40</b>	8	40 07157 62973 9
<b>25</b>	50 mm	E 6,3	1/4" 5	<b>036 255 40</b>	8	40 07157 62975 3
<b>30</b>	50 mm	E 6,3	1/4" 5	<b>036 305 40</b>	9	40 07157 62977 7
<b>40</b>	50 mm	E 6,3	1/4" 5	<b>036 405 40</b>	9	40 07157 62979 1



- Oțeluri selectate de înaltă performanță • geometrie optimizată • producție personalizată
- nagy teljesítményű acél • optimalizált geometria • egyedi gyártás

## TORSION Torziós

**Biții de înaltă performanță ce absorb vârful de torsiune  
Măresc substanțial durata de viață a sculei, reduc presiunea de contact**

*A nagy teljesítményű bit • elnyeli a hirtelen nyomatékterhelést*

*• jelentősen meghosszabbítja a bitek élettartamát • csökkenti az indulási nyomatékot*

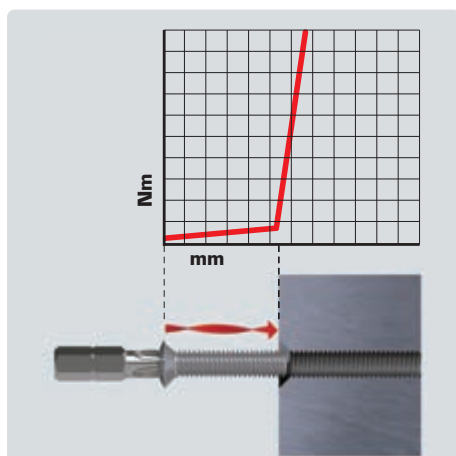

**Șuruburi de înbinare în suprafețe tari**

**Șuruburi de înbinare în suprafețe tari  
Problema:**

**Vârful brusc de torsiune produs atunci când capul șurubului atinge suprafața în care este înșurubat, poate distruge atât șurubul cât și bitul.**

**Soluția:**  
**Biții TORSION de la Felo absorb vârful de torsiune, prevenind efectiv distrugerea biților.**

**Kemény becsavarási felület**

**Probléma:**  
*A hirtelen nyomatékterhelés eltörheti a bitet vagy a csavarfejet és megrongálhatja a munkadarabot*

**Megoldás:**  
*A FELO TORSION bitek elnyelik a hirtelen nyomatékterhelést, így megakadályozzák a törés okozta károkat.*

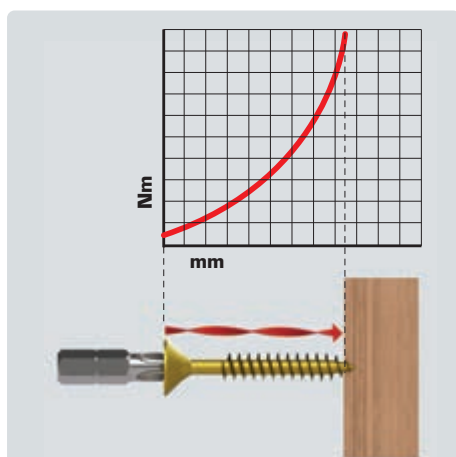

**Șuruburi de înbinare în suprafețe moi**

**De ex. înșurubarea în lemn, cu o torsiune ce crește treptat**

**Avantaj extra:**  
**Profile special rezistente la uzură cresc durata de viață a biților**

**Rugalmas becsavarási felület például:**

**facsavearak,**  
*a nyomaték folyamatosan növekszik a behajtás ideje alatt*

**Extra előny:**  
*A különösen kopásálló profil növeli a bitek élettartamát.*



## 021 C 6,3



felo  
Innovations



TORSION PZ				Item No		EAN-Code
1	25 mm	C 6,3 1/4"	5	<b>021 010 00</b>	4	40 07157 62873 2
2	25 mm	C 6,3 1/4"	5	<b>021 020 00</b>	4	40 07157 62875 6
3	25 mm	C 6,3 1/4"	5	<b>021 030 00</b>	5	40 07157 62877 0

## 022 C 6,3



felo  
Innovations



TORSION PH				Item No		EAN-Code
1	25 mm	C 6,3 1/4"	5	<b>022 010 00</b>	4	40 07157 62867 1
2	25 mm	C 6,3 1/4"	5	<b>022 020 00</b>	4	40 07157 62869 5
3	25 mm	C 6,3 1/4"	5	<b>022 030 00</b>	5	40 07157 62871 8

## 026 C 6,3



felo  
Innovations



TORSION Torx®				Item No		EAN-Code
10	25 mm	C 6,3 1/4"	5	<b>026 100 00</b>	4	40 07157 62879 4
15	25 mm	C 6,3 1/4"	5	<b>026 150 00</b>	4	40 07157 62881 7
20	25 mm	C 6,3 1/4"	5	<b>026 200 00</b>	4	40 07157 62883 1
25	25 mm	C 6,3 1/4"	5	<b>026 250 00</b>	4	40 07157 62885 5
30	25 mm	C 6,3 1/4"	5	<b>026 300 00</b>	5	40 07157 62887 9
40	25 mm	C 6,3 1/4"	5	<b>026 400 00</b>	5	40 07157 62889 3

## 031 E 6,3



felo  
Innovations



TORSION PZ				Item No		EAN-Code
1	50 mm	E 6,3 1/4"	5	<b>031 015 00</b>	8	40 07157 62903 6
2	50 mm	E 6,3 1/4"	5	<b>031 025 00</b>	8	40 07157 62905 0
3	50 mm	E 6,3 1/4"	5	<b>031 035 00</b>	9	40 07157 62907 4

## 032 E 6,3



felo  
Innovations



TORSION PH				Item No		EAN-Code
1	50 mm	E 6,3 1/4"	5	<b>032 015 00</b>	8	40 07157 62891 6
2	50 mm	E 6,3 1/4"	5	<b>032 025 00</b>	8	40 07157 62893 0
3	50 mm	E 6,3 1/4"	5	<b>032 035 00</b>	9	40 07157 62895 4

## Bits Challenger



**Diamond coated**



### 020 C 6,3



**felo**  
Innovations

						Item No		EAN-Code
	<b>0,6 x 4,5</b>	25 mm	C 6,3	1/4"	10	<b>020 400 80</b>	4	40 07157 50647 4
	<b>1,0 x 5,5</b>	25 mm	C 6,3	1/4"	10	<b>020 520 80</b>	5	40 07157 50649 8
	<b>1,2 x 6,5</b>	25 mm	C 6,3	1/4"	10	<b>020 610 80</b>	5	40 07157 50651 1
	<b>1,2 x 8,0</b>	25 mm	C 6,3	1/4"	10	<b>020 800 80</b>	7	40 07157 50653 5

### 021 C 6,3



**felo**  
Innovations

	<b>PZ</b>					Item No		EAN-Code
	<b>1</b>	25 mm	C 6,3	1/4"	10	<b>021 010 80</b>	4	40 07157 50661 0
	<b>2</b>	25 mm	C 6,3	1/4"	10	<b>021 020 80</b>	5	40 07157 50663 4
	<b>3</b>	25 mm	C 6,3	1/4"	10	<b>021 030 80</b>	5	40 07157 50665 8

### 022 C 6,3



**felo**  
Innovations

	<b>PH</b>					Item No		EAN-Code
	<b>1</b>	25 mm	C 6,3	1/4"	10	<b>022 010 80</b>	4	40 07157 50655 9
	<b>2</b>	25 mm	C 6,3	1/4"	10	<b>022 020 80</b>	5	40 07157 50657 3
	<b>3</b>	25 mm	C 6,3	1/4"	10	<b>022 030 80</b>	5	40 07157 50659 7

## 026 C 6,3



**felo**  
Innovations



Torx®				Item No		EAN-Code
<b>10</b>	25 mm	C 6,3 1/4"	10	<b>026 100 80</b>	4	40 07157 50667 2
<b>15</b>	25 mm	C 6,3 1/4"	10	<b>026 150 80</b>	4	40 07157 50669 6
<b>20</b>	25 mm	C 6,3 1/4"	10	<b>026 200 80</b>	4	40 07157 50671 9
<b>25</b>	25 mm	C 6,3 1/4"	10	<b>026 250 80</b>	5	40 07157 50673 3
<b>30</b>	25 mm	C 6,3 1/4"	10	<b>026 300 80</b>	5	40 07157 50675 7
<b>40</b>	25 mm	C 6,3 1/4"	10	<b>026 400 80</b>	6	40 07157 50677 1

## 031 E 6,3



**felo**  
Innovations



PZ				Item No		EAN-Code
<b>1</b>	50 mm	E 6,3 1/4"	10	<b>031 015 80</b>	9	40 07157 50685 6
<b>2</b>	50 mm	E 6,3 1/4"	10	<b>031 025 80</b>	10	40 07157 50687 0
<b>3</b>	50 mm	E 6,3 1/4"	10	<b>031 035 80</b>	11	40 07157 50689 4

## 032 E 6,3



**felo**  
Innovations



PH				Item No		EAN-Code
<b>1</b>	50 mm	E 6,3 1/4"	10	<b>032 015 80</b>	9	40 07157 50679 5
<b>2</b>	50 mm	E 6,3 1/4"	10	<b>032 025 80</b>	11	40 07157 50681 8
<b>3</b>	50 mm	E 6,3 1/4"	10	<b>032 035 80</b>	11	40 07157 50683 2

## Bits TiN Plus

TiN (>90 HRC)  
SX 75 (>60 HRC)

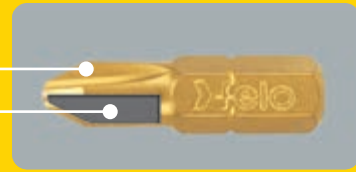

### 020 C 6,3 TiN



						Item No		EAN-Code
<b>0,8 x 5,0</b>	25 mm	C 6,3	1/4"	10	<b>020 500 70</b>	5	40 07157 30907 5	
<b>1,0 x 5,5</b>	25 mm	C 6,3	1/4"	10	<b>020 520 70</b>	5	40 07157 30911 2	
<b>1,2 x 6,5</b>	25 mm	C 6,3	1/4"	10	<b>020 610 70</b>	5	40 07157 30916 7	
<b>1,2 x 8,0</b>	25 mm	C 6,3	1/4"	10	<b>020 800 70</b>	6	40 07157 30921 1	

### 021 C 6,3 TiN



	PZ					Item No		EAN-Code
<b>1</b>	25 mm	C 6,3	1/4"	10	<b>021 010 70</b>	5	40 07157 10313 0	
<b>1 (100)</b>	25 mm	C 6,3	1/4"	1	<b>021 010 77</b>	500	40 07157 53415 6	
<b>2</b>	25 mm	C 6,3	1/4"	10	<b>021 020 70</b>	5	40 07157 10314 7	
<b>2 (100)</b>	25 mm	C 6,3	1/4"	1	<b>021 020 76</b>	500	40 07157 53417 0	
<b>3</b>	25 mm	C 6,3	1/4"	10	<b>021 030 70</b>	5	40 07157 10315 4	
<b>3 (100)</b>	25 mm	C 6,3	1/4"	1	<b>021 030 77</b>	500	40 07157 53419 4	

### 022 C 6,3 TiN



	PH					Item No		EAN-Code
<b>1</b>	25 mm	C 6,3	1/4"	10	<b>022 010 70</b>	5	40 07157 10316 1	
<b>1 (100)</b>	25 mm	C 6,3	1/4"	1	<b>022 010 77</b>	500	40 07157 53421 7	
<b>2</b>	25 mm	C 6,3	1/4"	10	<b>022 020 70</b>	5	40 07157 10317 8	
<b>2 (100)</b>	25 mm	C 6,3	1/4"	1	<b>022 020 77</b>	500	40 07157 52339 6	
<b>3</b>	25 mm	C 6,3	1/4"	10	<b>022 030 70</b>	6	40 07157 10318 5	

# 022 C 6,3 TiN







extra slim



PH					Item No		EAN-Code
2	25 mm	C 6,3	1/4"	10	<b>022 002 70</b>	5	40 07157 52471 3

# 026 C 6,3 TiN



Torx®					Item No		EAN-Code
<b>6</b>	25 mm	C 6,3	1/4"	10	<b>026 060 70</b>	4	40 07157 50212 4
<b>7</b>	25 mm	C 6,3	1/4"	10	<b>026 070 70</b>	4	40 07157 50214 8
<b>8</b>	25 mm	C 6,3	1/4"	10	<b>026 080 70</b>	4	40 07157 50216 2
<b>9</b>	25 mm	C 6,3	1/4"	10	<b>026 090 70</b>	4	40 07157 50218 6
<b>10</b>	25 mm	C 6,3	1/4"	10	<b>026 100 70</b>	5	40 07157 50220 9
<b>15</b>	25 mm	C 6,3	1/4"	10	<b>026 150 70</b>	5	40 07157 50222 3
<b>15 (100)</b>	25 mm	C 6,3	1/4"	1	<b>026 150 77</b>	500	40 07157 52321 1
<b>20</b>	25 mm	C 6,3	1/4"	10	<b>026 200 70</b>	5	40 07157 50224 7
<b>20 (100)</b>	25 mm	C 6,3	1/4"	1	<b>026 200 77</b>	500	40 07157 52323 5
<b>25</b>	25 mm	C 6,3	1/4"	10	<b>026 250 70</b>	5	40 07157 50226 1
<b>25 (100)</b>	25 mm	C 6,3	1/4"	1	<b>026 250 77</b>	500	40 07157 52325 9
<b>27</b>	25 mm	C 6,3	1/4"	10	<b>026 270 70</b>	5	40 07157 50228 5
<b>30</b>	25 mm	C 6,3	1/4"	10	<b>026 300 70</b>	6	40 07157 50230 8
<b>40</b>	25 mm	C 6,3	1/4"	10	<b>026 400 70</b>	6	40 07157 50232 2
<b>45</b>	25 mm	C 6,3	1/4"	10	<b>026 450 70</b>	7	40 07157 50234 6

## 031 E 6,3 TiN



PZ				Item No		EAN-Code
1	50 mm	E 6,3 1/4"	10	<b>031 015 70</b>	9	40 07157 30801 6
2	50 mm	E 6,3 1/4"	10	<b>031 025 70</b>	11	40 07157 30806 1
3	50 mm	E 6,3 1/4"	10	<b>031 035 70</b>	12	40 07157 30813 9

## 032 E 6,3 TiN



PH				Item No		EAN-Code
1	50 mm	E 6,3 1/4"	10	<b>032 015 70</b>	9	40 07157 30818 4
2	50 mm	E 6,3 1/4"	10	<b>032 025 70</b>	11	40 07157 30824 5
3	50 mm	E 6,3 1/4"	10	<b>032 035 70</b>	12	40 07157 30831 3

## 036 E 6,3 TiN







Torx®				Item No		EAN-Code
10	50 mm	E 6,3 1/4"	10	<b>036 105 70</b>	8	4007157 32372 9
15	50 mm	E 6,3 1/4"	10	<b>036 155 70</b>	9	4007157 32374 3
20	50 mm	E 6,3 1/4"	10	<b>036 205 70</b>	9	4007157 32376 7
25	50 mm	E 6,3 1/4"	10	<b>036 255 70</b>	9	4007157 32378 1
30	50 mm	E 6,3 1/4"	10	<b>036 305 70</b>	11	4007157 32380 4
40	50 mm	E 6,3 1/4"	10	<b>036 405 70</b>	12	4007157 32382 8







### 031 E 6,3 TiN



PZ					Item No		EAN-Code
1	73 mm	E 6,3	1/4"	5	<b>031 017 70</b>	12	40 07157 30803 0
2	73 mm	E 6,3	1/4"	5	<b>031 027 70</b>	16	40 07157 30808 5

### 032 E 6,3 TiN







PH					Item No		EAN-Code
1	73 mm	E 6,3	1/4"	5	<b>032 017 70</b>	12	40 07157 30820 7
2	73 mm	E 6,3	1/4"	5	<b>032 027 70</b>	16	40 07157 30826 9

## Bits Industrial







### 020 C 6,3



						Item No		EAN-Code
<b>0,5 x 4,0</b>		25 mm	C 6,3	1/4"	10	<b>020 210 10</b>	5	40 07157 24037 8
<b>0,5 x 3,0</b>		25 mm	C 6,3	1/4"	10	<b>020 300 10</b>	4	40 07157 30066 9
<b>0,6 x 3,5</b>		25 mm	C 6,3	1/4"	10	<b>020 310 10</b>	4	40 07157 30070 6
<b>0,6 x 4,5</b>		25 mm	C 6,3	1/4"	10	<b>020 400 10</b>	5	40 07157 30904 4
<b>0,8 x 4,0</b>		25 mm	C 6,3	1/4"	10	<b>020 410 10</b>	5	40 07157 30079 9
<b>0,8 x 5,0</b>		25 mm	C 6,3	1/4"	10	<b>020 500 10</b>	5	40 07157 30089 8
<b>0,8 x 5,5</b>		25 mm	C 6,3	1/4"	10	<b>020 510 10</b>	5	40 07157 30097 3
<b>1,0 x 5,5</b>		25 mm	C 6,3	1/4"	10	<b>020 520 10</b>	5	40 07157 30105 5
<b>1,0 x 6,0</b>		25 mm	C 6,3	1/4"	10	<b>020 600 10</b>	5	40 07157 30112 3
<b>1,2 x 6,5</b>		25 mm	C 6,3	1/4"	10	<b>020 610 10</b>	6	40 07157 30119 2
<b>1,2 x 8,0</b>		25 mm	C 6,3	1/4"	10	<b>020 800 10</b>	7	40 07157 30918 1





### 021 C 6,3



	PZ					Item No		EAN-Code
<b>0</b>		25 mm	C 6,3	1/4"	10	<b>021 000 10</b>	4	40 07157 24025 5
<b>1</b>		25 mm	C 6,3	1/4"	10	<b>021 010 10</b>	5	40 07157 30159 8
<b>1 (100)</b>		25 mm	C 6,3	1/4"	1	<b>021 010 17</b>	500	40 07157 30925 9
<b>2</b>		25 mm	C 6,3	1/4"	10	<b>021 020 10</b>	5	40 07157 30169 7
<b>2 (100)</b>		25 mm	C 6,3	1/4"	1	<b>021 020 17</b>	520	40 07157 30928 0
<b>3</b>		25 mm	C 6,3	1/4"	10	<b>021 030 10</b>	6	40 07157 30180 2
<b>3 (100)</b>		25 mm	C 6,3	1/4"	1	<b>021 030 17</b>	540	40 07157 31353 9
<b>4</b>		32 mm	C 6,3	1/4"	10	<b>021 042 10</b>	12	40 07157 30190 1

### 022 C 6,3



	PH					Item No		EAN-Code
<b>0</b>		25 mm	C 6,3	1/4"	10	<b>022 000 10</b>	4	40 07157 30937 2
<b>1</b>		25 mm	C 6,3	1/4"	10	<b>022 010 10</b>	5	40 07157 30193 2
<b>1 (100)</b>		25 mm	C 6,3	1/4"	1	<b>022 010 17</b>	470	40 07157 30940 2
<b>2</b>		25 mm	C 6,3	1/4"	10	<b>022 020 10</b>	5	40 07157 30205 2
<b>2 (100)</b>		25 mm	C 6,3	1/4"	1	<b>022 020 17</b>	510	40 07157 30943 3
<b>3</b>		25 mm	C 6,3	1/4"	10	<b>022 030 10</b>	6	40 07157 30218 2
<b>3 (100)</b>		25 mm	C 6,3	1/4"	1	<b>022 030 17</b>	560	40 07157 31351 5
<b>4</b>		32 mm	C 6,3	1/4"	10	<b>022 042 10</b>	11	40 07157 30229 8

## 022 C 6,3



**extra slim**



PH				Item No		EAN-Code
2	25 mm	C 6,3	1/4"	10	4	40 07157 10238 6

## 021 C 6,3



PZ				Item No		EAN-Code
1	50 mm	C 6,3	1/4"	10	10	40 07157 32084 1
2	50 mm	C 6,3	1/4"	10	11	40 07157 30178 9
3	50 mm	C 6,3	1/4"	10	12	40 07157 30188 8

## 022 C 6,3



PH				Item No		EAN-Code
1	50 mm	C 6,3	1/4"	10	10	40 07157 53053 0
2	50 mm	C 6,3	1/4"	10	11	40 07157 30216 8
3	50 mm	C 6,3	1/4"	10	12	40 07157 30227 4

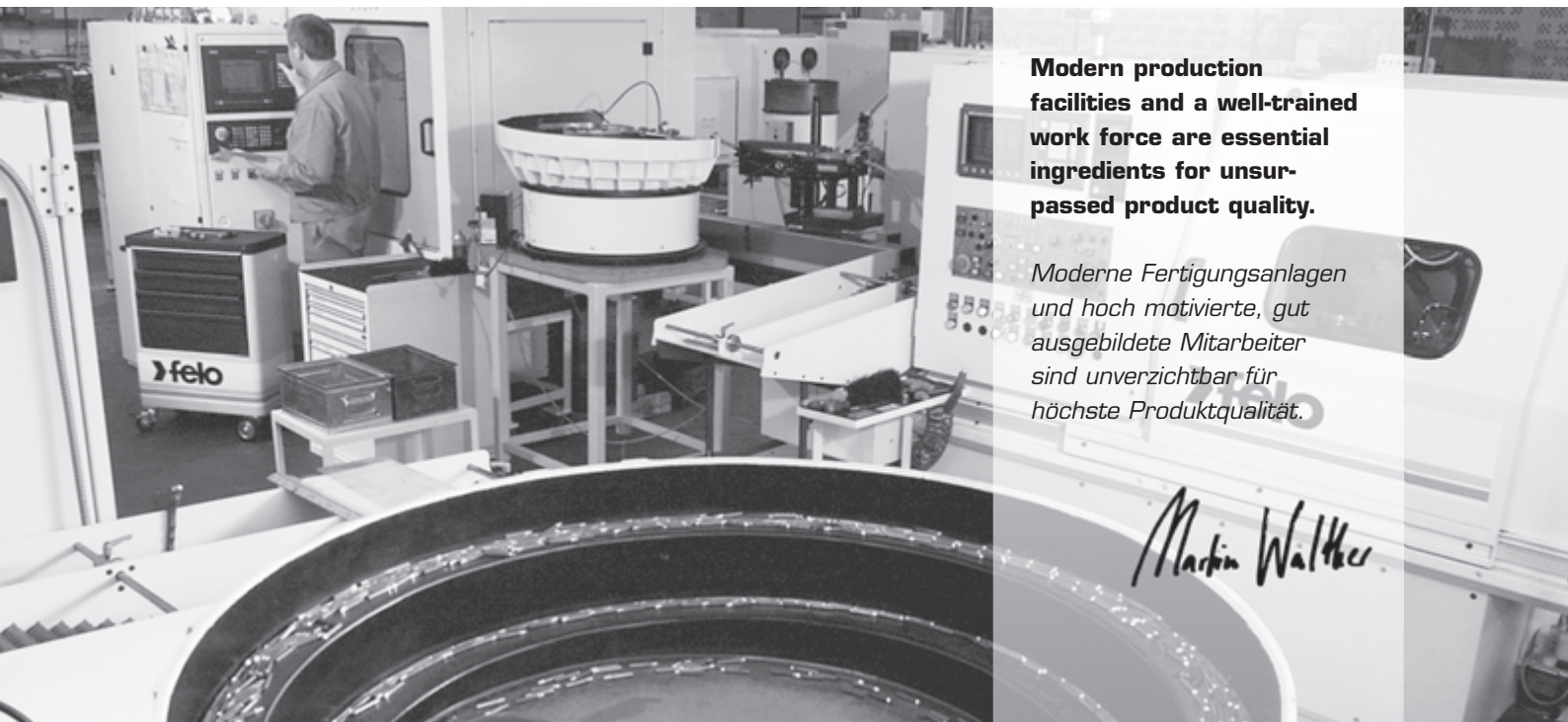

**Modern production facilities and a well-trained work force are essential ingredients for unsurpassed product quality.**

*Moderne Fertigungsanlagen und hoch motivierte, gut ausgebildete Mitarbeiter sind unverzichtbar für höchste Produktqualität.*

*Martin Walther*

## 024 C 6,3



mm				Item No		EAN-Code
<b>2,0</b>	25 mm	C 6,3 1/4"	10	<b>024 200 10</b>	5	40 07157 30952 5
<b>2,5</b>	25 mm	C 6,3 1/4"	10	<b>024 250 10</b>	5	40 07157 30253 3
<b>3,0</b>	25 mm	C 6,3 1/4"	10	<b>024 300 10</b>	5	40 07157 30255 7
<b>4,0</b>	25 mm	C 6,3 1/4"	10	<b>024 400 10</b>	5	40 07157 30257 1
<b>5,0</b>	25 mm	C 6,3 1/4"	10	<b>024 500 10</b>	6	40 07157 30259 5
<b>5,5</b>	25 mm	C 6,3 1/4"	10	<b>024 550 10</b>	6	40 07157 62319 5
<b>6,0</b>	25 mm	C 6,3 1/4"	10	<b>024 600 10</b>	7	40 07157 30261 8
<b>8,0</b>	25 mm	C 6,3 1/4"	10	<b>024 800 10</b>	9	40 07157 30263 2

## 025 C 6,3



SQ				Item No		EAN-Code
<b>0</b> (1,75 mm)	25 mm	C 6,3 1/4"	10	<b>025 000 10</b>	4	40 07157 50350 3
<b>1</b> (2,30 mm)	25 mm	C 6,3 1/4"	10	<b>025 100 10</b>	4	40 07157 50352 7
<b>2</b> (2,80 mm)	25 mm	C 6,3 1/4"	10	<b>025 200 10</b>	5	40 07157 50354 1
<b>3</b> (3,30 mm)	25 mm	C 6,3 1/4"	10	<b>025 300 10</b>	5	40 07157 50356 5





## 026 C 6,3



Torx®				Item No		EAN-Code
<b>5</b>	25 mm	C 6,3 1/4"	10	<b>026 050 10</b>	4	40 07157 50779 2
<b>6</b>	25 mm	C 6,3 1/4"	10	<b>026 060 10</b>	4	40 07157 30953 2
<b>7</b>	25 mm	C 6,3 1/4"	10	<b>026 070 10</b>	4	40 07157 30954 9
<b>8</b>	25 mm	C 6,3 1/4"	10	<b>026 080 10</b>	4	40 07157 30955 6
<b>9</b>	25 mm	C 6,3 1/4"	10	<b>026 090 10</b>	4	40 07157 30956 3
<b>10</b>	25 mm	C 6,3 1/4"	10	<b>026 100 10</b>	5	40 07157 30957 0
<b>10 (100)</b>	25 mm	C 6,3 1/4"	1	<b>026 100 17</b>	460	40 07157 31561 8
<b>15</b>	25 mm	C 6,3 1/4"	10	<b>026 150 10</b>	5	40 07157 30959 4
<b>15 (100)</b>	25 mm	C 6,3 1/4"	1	<b>026 150 17</b>	480	40 07157 31563 2
<b>20</b>	25 mm	C 6,3 1/4"	10	<b>026 200 10</b>	5	40 07157 30961 7
<b>20 (100)</b>	25 mm	C 6,3 1/4"	1	<b>026 200 17</b>	510	40 07157 31565 6
<b>25</b>	25 mm	C 6,3 1/4"	10	<b>026 250 10</b>	5	40 07157 30963 1
<b>25 (100)</b>	25 mm	C 6,3 1/4"	1	<b>026 250 17</b>	530	40 07157 31567 0
<b>27</b>	25 mm	C 6,3 1/4"	10	<b>026 270 10</b>	5	40 07157 30965 5
<b>30</b>	25 mm	C 6,3 1/4"	10	<b>026 300 10</b>	6	40 07157 30967 9
<b>30 (100)</b>	25 mm	C 6,3 1/4"	1	<b>026 300 17</b>	620	40 07157 32569 4
<b>40</b>	25 mm	C 6,3 1/4"	10	<b>026 400 10</b>	6	40 07157 30969 3
<b>40 (100)</b>	25 mm	C 6,3 1/4"	1	<b>026 400 17</b>	620	40 07157 31571 7
<b>45</b>	25 mm	C 6,3 1/4"	10	<b>026 450 10</b>	7	40 07157 32076 6
<b>50</b>	26 mm	C 6,3 1/4"	10	<b>026 500 10</b>	8	40 07157 32450 4
<b>50</b>	32 mm	C 6,3 1/4"	10	<b>026 501 10</b>	10	40 07157 51399 1





## 027 C 6,3



Torx® TR				Item No		EAN-Code
<b>7</b>	25 mm	C 6,3	1/4"	10	<b>027 070 10</b>	4 40 07157 50771 6
<b>8</b>	25 mm	C 6,3	1/4"	10	<b>027 080 10</b>	4 40 07157 50773 0
<b>9</b>	25 mm	C 6,3	1/4"	10	<b>027 090 10</b>	4 40 07157 50775 4
<b>10</b>	25 mm	C 6,3	1/4"	10	<b>027 100 10</b>	5 40 07157 30971 6
<b>15</b>	25 mm	C 6,3	1/4"	10	<b>027 150 10</b>	5 40 07157 30972 3
<b>20</b>	25 mm	C 6,3	1/4"	10	<b>027 200 10</b>	5 40 07157 30973 0
<b>25</b>	25 mm	C 6,3	1/4"	10	<b>027 250 10</b>	5 40 07157 30974 7
<b>27</b>	25 mm	C 6,3	1/4"	10	<b>027 270 10</b>	5 40 07157 30975 4
<b>30</b>	25 mm	C 6,3	1/4"	10	<b>027 300 10</b>	6 40 07157 30976 1
<b>40</b>	25 mm	C 6,3	1/4"	10	<b>027 400 10</b>	6 40 07157 30977 8





## 023 C 6,3



Torx Plus®				Item No		EAN-Code
<b>6 IP</b>	25 mm	C 6,3	1/4"	10	<b>023 060 10</b>	4 40 07157 51341 0
<b>7 IP</b>	25 mm	C 6,3	1/4"	10	<b>023 070 10</b>	4 40 07157 51343 4
<b>8 IP</b>	25 mm	C 6,3	1/4"	10	<b>023 080 10</b>	4 40 07157 51345 8
<b>9 IP</b>	25 mm	C 6,3	1/4"	10	<b>023 090 10</b>	4 40 07157 51347 2
<b>10 IP</b>	25 mm	C 6,3	1/4"	10	<b>023 100 10</b>	5 40 07157 51349 6
<b>15 IP</b>	25 mm	C 6,3	1/4"	10	<b>023 150 10</b>	5 40 07157 51351 9
<b>20 IP</b>	25 mm	C 6,3	1/4"	10	<b>023 200 10</b>	5 40 07157 51353 3
<b>25 IP</b>	25 mm	C 6,3	1/4"	10	<b>023 250 10</b>	5 40 07157 51355 7
<b>27 IP</b>	25 mm	C 6,3	1/4"	10	<b>023 270 10</b>	6 40 07157 51357 1
<b>30 IP</b>	25 mm	C 6,3	1/4"	10	<b>023 300 10</b>	6 40 07157 51359 5
<b>40 IP</b>	25 mm	C 6,3	1/4"	10	<b>023 400 10</b>	6 40 07157 51361 8

## 028 C 6,3



Clutch				Item No		EAN-Code
<b>5/32"</b>	25 mm	C 6,3	1/4"	10	<b>028 930 10</b>	5 40 07157 52271 9
<b>1/4"</b>	25 mm	C 6,3	1/4"	10	<b>028 940 10</b>	6 40 07157 52273 3

## 028 C 6,3



XZN				Item No		EAN-Code
<b>M 4</b>	25 mm	C 6,3 1/4"	10	<b>028 040 10</b>	5	40 07157 50360 2
<b>M 5</b>	25 mm	C 6,3 1/4"	10	<b>028 050 10</b>	5	40 07157 50362 6
<b>M 6</b>	25 mm	C 6,3 1/4"	10	<b>028 060 10</b>	6	40 07157 50364 0
<b>M 8</b>	25 mm	C 6,3 1/4"	10	<b>028 080 10</b>	6	40 07157 50366 4
<b>M10</b>	25 mm	C 6,3 1/4"	10	<b>028 100 10</b>	8	40 07157 50368 8

## 029 C 6,3



TS				Item No		EAN-Code
<b>0</b>	25 mm	C 6,3 1/4"	10	<b>029 000 10</b>	5	40 07157 50370 1
<b>1</b>	25 mm	C 6,3 1/4"	10	<b>029 010 10</b>	6	40 07157 50372 5
<b>2</b>	25 mm	C 6,3 1/4"	10	<b>029 020 10</b>	5	40 07157 50374 9
<b>3</b>	25 mm	C 6,3 1/4"	10	<b>029 030 10</b>	5	40 07157 50376 3
<b>4</b>	25 mm	C 6,3 1/4"	10	<b>029 040 10</b>	5	40 07157 50378 7
<b>5</b>	25 mm	C 6,3 1/4"	10	<b>029 050 10</b>	5	40 07157 50380 0
<b>6</b>	25 mm	C 6,3 1/4"	10	<b>029 060 10</b>	5	40 07157 50382 4
<b>8</b>	25 mm	C 6,3 1/4"	10	<b>029 080 10</b>	6	40 07157 50536 1
<b>10</b>	25 mm	C 6,3 1/4"	10	<b>029 100 10</b>	6	40 07157 50819 5

## 029 C 6,3



Tri-Wing				Item No		EAN-Code
<b>1</b>	25 mm	C 6,3 1/4"	10	<b>029 510 10</b>	5	40 07157 52255 9
<b>2</b>	25 mm	C 6,3 1/4"	10	<b>029 520 10</b>	5	40 07157 52257 3
<b>3</b>	25 mm	C 6,3 1/4"	10	<b>029 530 10</b>	5	40 07157 52259 7
<b>4</b>	25 mm	C 6,3 1/4"	10	<b>029 540 10</b>	5	40 07157 52261 0
<b>5</b>	25 mm	C 6,3 1/4"	10	<b>029 550 10</b>	5	40 07157 52263 4



## 020 C 6,3



Spanner				Item No		EAN-Code
<b>6</b>	25 mm	C 6,3 1/4"	10	<b>020 906 10</b>	5	40 07157 52265 8
<b>8</b>	25 mm	C 6,3 1/4"	10	<b>020 908 10</b>	5	40 07157 52267 2
<b>10</b>	25 mm	C 6,3 1/4"	10	<b>020 910 10</b>	5	40 07157 52269 6





## 030 E 6,3



						Item No		EAN-Code
	<b>0,5 x 3,0</b>	50 mm	E 6,3	1/4"	10	<b>030 305 10</b>	8	40 07157 30772 9
	<b>0,6 x 3,5</b>	50 mm	E 6,3	1/4"	10	<b>030 315 10</b>	8	40 07157 30275 5
	<b>0,8 x 4,0</b>	50 mm	E 6,3	1/4"	10	<b>030 415 10</b>	9	40 07157 30277 9
	<b>0,6 x 4,5</b>	50 mm	E 6,3	1/4"	10	<b>030 455 10</b>	9	40 07157 30779 8
	<b>0,8 x 5,0</b>	50 mm	E 6,3	1/4"	10	<b>030 505 10</b>	9	40 07157 30280 9
	<b>0,8 x 5,5</b>	50 mm	E 6,3	1/4"	10	<b>030 515 10</b>	10	40 07157 30283 0
	<b>1,0 x 5,5</b>	50 mm	E 6,3	1/4"	10	<b>030 525 10</b>	10	40 07157 30285 4
	<b>1,0 x 6,0</b>	50 mm	E 6,3	1/4"	10	<b>030 605 10</b>	11	40 07157 30287 8
	<b>1,2 x 6,5</b>	50 mm	E 6,3	1/4"	10	<b>030 615 10</b>	12	40 07157 30290 8
	<b>1,2 x 8,0</b>	50 mm	E 6,3	1/4"	10	<b>030 805 10</b>	14	40 07157 30292 2
	<b>1,6 x 8,0</b>	50 mm	E 6,3	1/4"	10	<b>030 815 10</b>	14	40 07157 30294 6
	<b>1,6 x 10,0</b>	50 mm	E 6,3	1/4"	10	<b>030 105 10</b>	17	40 07157 30272 4





## 031 E 6,3



	PZ					Item No		EAN-Code
	<b>1</b>	50 mm	E 6,3	1/4"	10	<b>031 015 10</b>	9	40 07157 30309 7
	<b>2</b>	50 mm	E 6,3	1/4"	10	<b>031 025 10</b>	11	40 07157 30312 7
	<b>3</b>	50 mm	E 6,3	1/4"	10	<b>031 035 10</b>	11	40 07157 30315 8





## 032 E 6,3



	PH					Item No		EAN-Code
	<b>0</b>	50 mm	E 6,3	1/4"	10	<b>032 005 10</b>	8	40 07157 51015 0
	<b>1</b>	50 mm	E 6,3	1/4"	10	<b>032 015 10</b>	9	40 07157 30317 2
	<b>2</b>	50 mm	E 6,3	1/4"	10	<b>032 025 10</b>	11	40 07157 30320 2
	<b>2 (100)</b>	50 mm	E 6,3	1/4"	1	<b>032 025 17</b>	1100	40 07157 31956 2
	<b>3</b>	50 mm	E 6,3	1/4"	10	<b>032 035 10</b>	12	40 07157 30323 3

## 033 E 6,3



	Torx Plus®					Item No		EAN-Code
	<b>10 IP</b>	50 mm	E 6,3	1/4"	10	<b>033 105 10</b>	8	40 07157 51363 2
	<b>15 IP</b>	50 mm	E 6,3	1/4"	10	<b>033 155 10</b>	9	40 07157 51365 6
	<b>20 IP</b>	50 mm	E 6,3	1/4"	10	<b>033 205 10</b>	9	40 07157 51367 0
	<b>25 IP</b>	50 mm	E 6,3	1/4"	10	<b>033 255 10</b>	10	40 07157 51369 4
	<b>30 IP</b>	50 mm	E 6,3	1/4"	10	<b>033 305 10</b>	11	40 07157 51371 7

## 034 E 6,3



mm					Item No		EAN-Code
<b>2,5</b>	50 mm	E 6,3	1/4"	10	<b>034 255 10</b>	11	40 07157 30325 7
<b>3,0</b>	50 mm	E 6,3	1/4"	10	<b>034 305 10</b>	11	40 07157 30327 1
<b>4,0</b>	50 mm	E 6,3	1/4"	10	<b>034 405 10</b>	12	40 07157 30329 5
<b>5,0</b>	50 mm	E 6,3	1/4"	10	<b>034 505 10</b>	12	40 07157 30331 8
<b>6,0</b>	50 mm	E 6,3	1/4"	10	<b>034 605 10</b>	13	40 07157 30333 2
<b>8,0</b>	50 mm	E 6,3	1/4"	10	<b>034 805 10</b>	17	40 07157 31878 7

## 035 E 6,3



sq					Item No		EAN-Code
<b>1 (2,30 mm)</b>	50 mm	E 6,3	1/4"	10	<b>035 105 10</b>	11	40 07157 63601 0
<b>2 (2,80 mm)</b>	50 mm	E 6,3	1/4"	10	<b>035 205 10</b>	11	40 07157 63603 4
<b>3 (3,30 mm)</b>	50 mm	E 6,3	1/4"	10	<b>035 305 10</b>	12	40 07157 63605 8

## 036 E 6,3









Torx®					Item No		EAN-Code
<b>5</b>	50 mm	E 6,3	1/4"	10	<b>036 055 10</b>	7	40 07157 50973 4
<b>6</b>	50 mm	E 6,3	1/4"	10	<b>036 065 10</b>	7	40 07157 51375 5
<b>7</b>	50 mm	E 6,3	1/4"	10	<b>036 075 10</b>	7	40 07157 51377 9
<b>8</b>	50 mm	E 6,3	1/4"	10	<b>036 085 10</b>	8	40 07157 30834 4
<b>9</b>	50 mm	E 6,3	1/4"	10	<b>036 095 10</b>	8	40 07157 30835 1
<b>10</b>	50 mm	E 6,3	1/4"	10	<b>036 105 10</b>	9	40 07157 30836 8
<b>15</b>	50 mm	E 6,3	1/4"	10	<b>036 155 10</b>	8	40 07157 24026 2
<b>20</b>	50 mm	E 6,3	1/4"	10	<b>036 205 10</b>	9	40 07157 30839 9
<b>25</b>	50 mm	E 6,3	1/4"	10	<b>036 255 10</b>	9	40 07157 30841 2
<b>27</b>	50 mm	E 6,3	1/4"	10	<b>036 275 10</b>	9	40 07157 30843 6
<b>30</b>	50 mm	E 6,3	1/4"	10	<b>036 305 10</b>	11	40 07157 30845 0
<b>40</b>	50 mm	E 6,3	1/4"	10	<b>036 405 10</b>	12	40 07157 30847 4







## 030 E 6,3



						Item No		EAN-Code
	<b>0,5 x 3,0</b>	73 mm	E 6,3	1/4"	5	<b>030 307 10</b>	9	40 07157 30274 8
	<b>0,6 x 3,5</b>	73 mm	E 6,3	1/4"	5	<b>030 317 10</b>	11	40 07157 30773 6
	<b>0,8 x 4,0</b>	73 mm	E 6,3	1/4"	5	<b>030 417 10</b>	11	40 07157 30279 3
	<b>0,8 x 5,0</b>	73 mm	E 6,3	1/4"	5	<b>030 507 10</b>	11	40 07157 30282 3
	<b>1,0 x 5,5</b>	73 mm	E 6,3	1/4"	5	<b>030 527 10</b>	14	40 07157 30787 3
	<b>1,2 x 6,5</b>	73 mm	E 6,3	1/4"	5	<b>030 617 10</b>	17	40 07157 30794 1





## 031 E 6,3



	<b>PZ</b>					Item No		EAN-Code
	<b>1</b>	73 mm	E 6,3	1/4"	5	<b>031 017 10</b>	12	40 07157 30311 0
	<b>2</b>	73 mm	E 6,3	1/4"	5	<b>031 027 10</b>	16	40 07157 30314 1
	<b>3</b>	73 mm	E 6,3	1/4"	5	<b>031 037 10</b>	18	40 07157 30815 3





## 032 E 6,3



	<b>PH</b>					Item No		EAN-Code
	<b>1</b>	73 mm	E 6,3	1/4"	5	<b>032 017 10</b>	12	40 07157 30319 6
	<b>2</b>	73 mm	E 6,3	1/4"	5	<b>032 027 10</b>	16	40 07157 30322 6
	<b>3</b>	73 mm	E 6,3	1/4"	5	<b>032 037 10</b>	18	40 07157 30833 7





## 035 E 6,3



	<b>SQ</b>					Item No		EAN-Code
	<b>0</b> (1,75 mm)	73 mm	E 6,3	1/4"	5	<b>035 007 10</b>	17	40 07157 31520 5
	<b>1</b> (2,30 mm)	73 mm	E 6,3	1/4"	5	<b>035 017 10</b>	17	40 07157 31522 9
	<b>2</b> (2,80 mm)	73 mm	E 6,3	1/4"	5	<b>035 027 10</b>	18	40 07157 31524 3
	<b>3</b> (3,30 mm)	73 mm	E 6,3	1/4"	5	<b>035 037 10</b>	18	40 07157 31526 7

## 036 E 6,3



	<b>Torx®</b>					Item No		EAN-Code
	<b>10</b>	73 mm	E 6,3	1/4"	3	<b>036 107 10</b>	10	40 07157 30837 5
	<b>15</b>	73 mm	E 6,3	1/4"	3	<b>036 157 10</b>	11	40 07157 30838 2
	<b>20</b>	73 mm	E 6,3	1/4"	3	<b>036 207 10</b>	12	40 07157 30840 5
	<b>25</b>	73 mm	E 6,3	1/4"	3	<b>036 257 10</b>	13	40 07157 30842 9
	<b>27</b>	73 mm	E 6,3	1/4"	3	<b>036 277 10</b>	14	40 07157 30844 3
	<b>30</b>	73 mm	E 6,3	1/4"	3	<b>036 307 10</b>	17	40 07157 30846 7
	<b>40</b>	73 mm	E 6,3	1/4"	3	<b>036 407 10</b>	19	40 07157 30848 1

## 031 E 6,3



For terminal block screws



PlusMinus				Item No		EAN-Code
Z 1	73 mm	E 6,3	1/4"	5	<b>031 101 10</b>	12 40 07157 51883 5
Z 2	73 mm	E 6,3	1/4"	5	<b>031 202 10</b>	16 40 07157 51885 9

## 032 E 6,3



For terminal block screws



PlusMinus				Item No		EAN-Code
H 1	73 mm	E 6,3	1/4"	5	<b>032 101 10</b>	12 40 07157 51879 8
H 2	73 mm	E 6,3	1/4"	5	<b>032 202 10</b>	16 40 07157 51881 1

## 036 E 6,3



Torx®



Item No



EAN-Code



20	90 mm	E 6,3	1/4"	3	<b>036 209 10</b>	12 40 07157 51255 0
25	90 mm	E 6,3	1/4"	3	<b>036 259 10</b>	12 40 07157 51253 6
30	90 mm	E 6,3	1/4"	2	<b>036 309 10</b>	13 40 07157 51407 3

## 030 E 6,3



Item No



EAN-Code



<b>0,8 x 4,0</b>	100 mm	E 6,3	1/4"	3	<b>030 418 10</b>	14 40 07157 30778 1
<b>1,0 x 5,5</b>	100 mm	E 6,3	1/4"	3	<b>030 528 10</b>	19 40 07157 30788 0
<b>1,2 x 6,5</b>	100 mm	E 6,3	1/4"	3	<b>030 618 10</b>	24 40 07157 30795 8
<b>1,2 x 8,0</b>	100 mm	E 6,3	1/4"	3	<b>030 818 10</b>	33 40 07157 30800 9

## 031 E 6,3



PZ



Item No



EAN-Code



1	100 mm	E 6,3	1/4"	3	<b>031 018 10</b>	15 40 07157 30805 4
2	100 mm	E 6,3	1/4"	3	<b>031 028 10</b>	22 40 07157 30810 8
3	100 mm	E 6,3	1/4"	3	<b>031 038 10</b>	25 40 07157 30816 0

## 032 E 6,3



PH



Item No







EAN-Code



1	100 mm	E 6,3	1/4"	3	<b>032 018 10</b>	15 40 07157 30822 1
2	100 mm	E 6,3	1/4"	3	<b>032 028 10</b>	22 40 07157 30828 3





## 031 E 6,3



PZ					Item No		EAN-Code
1	150 mm	E 6,3	1/4"	3	<b>031 019 10</b>	22	40 07157 30752 1
2	150 mm	E 6,3	1/4"	3	<b>031 029 10</b>	33	40 07157 30812 2
3	150 mm	E 6,3	1/4"	3	<b>031 039 10</b>	39	40 07157 30817 7





## 032 E 6,3



PH					Item No		EAN-Code
1	150 mm	E 6,3	1/4"	3	<b>032 019 10</b>	22	40 07157 30823 8
2	150 mm	E 6,3	1/4"	3	<b>032 029 10</b>	33	40 07157 30830 6

## 036 E 6,3









Torx®					Item No		EAN-Code
10	150 mm	E 6,3	1/4"	3	<b>036 100 10</b>	22	40 07157 63839 7
15	150 mm	E 6,3	1/4"	3	<b>036 150 10</b>	22	40 07157 63565 5
20	150 mm	E 6,3	1/4"	3	<b>036 200 10</b>	33	40 07157 63567 9
25	150 mm	E 6,3	1/4"	3	<b>036 250 10</b>	39	40 07157 63569 3
30	150 mm	E 6,3	1/4"	3	<b>036 300 10</b>	42	40 07157 63571 6



Impact







							Item No		EAN-Code
	2 x	Impact <b>PZ 1</b>	25 mm	C 6,3	10		<b>021 012 41</b>	13	40 07157 63001 8
	2 x	Impact <b>PZ 2</b>	25 mm	C 6,3	10		<b>021 022 41</b>	13	40 07157 63003 2
	2 x	Impact <b>PZ 3</b>	25 mm	C 6,3	10		<b>021 032 41</b>	15	40 07157 63005 6
	1 x	Impact <b>PZ 1</b>	50 mm	E 6,3	10		<b>031 015 41</b>	18	40 07157 63025 4
	1 x	Impact <b>PZ 2</b>	50 mm	E 6,3	10		<b>031 025 41</b>	18	40 07157 63027 8
	1 x	Impact <b>PZ 3</b>	50 mm	E 6,3	10		<b>031 035 41</b>	19	40 07157 63029 2
	2 x	Impact <b>PH 1</b>	25 mm	C 6,3	10		<b>022 012 41</b>	13	40 07157 62995 1
	2 x	Impact <b>PH 2</b>	25 mm	C 6,3	10		<b>022 022 41</b>	13	40 07157 62997 5
	2 x	Impact <b>PH 3</b>	25 mm	C 6,3	10		<b>022 032 41</b>	15	40 07157 62999 9
	1 x	Impact <b>PH 1</b>	50 mm	E 6,3	10		<b>032 015 41</b>	18	40 07157 63019 3
	1 x	Impact <b>PH 2</b>	50 mm	E 6,3	10		<b>032 025 41</b>	18	40 07157 63021 6
	1 x	Impact <b>PH 3</b>	50 mm	E 6,3	10		<b>032 035 41</b>	19	40 07157 63023 0
	2 x	Impact <b>Torx® 10</b>	25 mm	C 6,3	10		<b>026 102 41</b>	13	40 07157 63007 0
	2 x	Impact <b>Torx® 15</b>	25 mm	C 6,3	10		<b>026 152 41</b>	13	40 07157 63009 4
	2 x	Impact <b>Torx® 20</b>	25 mm	C 6,3	10		<b>026 202 41</b>	13	40 07157 63011 7
	2 x	Impact <b>Torx® 25</b>	25 mm	C 6,3	10		<b>026 252 41</b>	13	40 07157 63013 1
	2 x	Impact <b>Torx® 30</b>	25 mm	C 6,3	10		<b>026 302 41</b>	15	40 07157 63015 5
	2 x	Impact <b>Torx® 40</b>	25 mm	C 6,3	10		<b>026 402 41</b>	15	40 07157 63017 9
	1 x	Impact <b>Torx® 10</b>	50 mm	E 6,3	10		<b>036 105 41</b>	18	40 07157 63031 5
	1 x	Impact <b>Torx® 15</b>	50 mm	E 6,3	10		<b>036 155 41</b>	18	40 07157 63033 9
	1 x	Impact <b>Torx® 20</b>	50 mm	E 6,3	10		<b>036 205 41</b>	18	40 07157 63035 3
	1 x	Impact <b>Torx® 25</b>	50 mm	E 6,3	10		<b>036 255 41</b>	18	40 07157 63037 7
	1 x	Impact <b>Torx® 30</b>	50 mm	E 6,3	10		<b>036 305 41</b>	19	40 07157 63039 1
	1 x	Impact <b>Torx® 40</b>	50 mm	E 6,3	10		<b>036 405 41</b>	19	40 07157 63041 4
	1 x	<b>Bitholder IMPACT 1/4" on Card / Bithalter A.K.</b>	95 mm	E 6,3	10		<b>038 295 94</b>	43	40 07157 63077 3



## Torsion







					 Item No		EAN-Code
	2 x	Torsion <b>PZ 1</b>	25 mm	C 6,3 10	<b>021 012 01</b>	13	40 07157 62915 9
	2 x	Torsion <b>PZ 2</b>	25 mm	C 6,3 10	<b>021 022 01</b>	13	40 07157 62917 3
	2 x	Torsion <b>PZ 3</b>	25 mm	C 6,3 10	<b>021 032 01</b>	15	40 07157 62919 7
	1 x	Torsion <b>PZ 1</b>	50 mm	E 6,3 10	<b>031 015 01</b>	18	40 07157 62987 6
	1 x	Torsion <b>PZ 2</b>	50 mm	E 6,3 10	<b>031 025 01</b>	18	40 07157 62989 0
	1 x	Torsion <b>PZ 3</b>	50 mm	E 6,3 10	<b>031 035 01</b>	18	40 07157 62991 3
	2 x	Torsion <b>PH 1</b>	25 mm	C 6,3 10	<b>022 012 01</b>	13	40 07157 62909 8
	2 x	Torsion <b>PH 2</b>	25 mm	C 6,3 10	<b>022 022 01</b>	13	40 07157 62911 1
	2 x	Torsion <b>PH 3</b>	25 mm	C 6,3 10	<b>022 032 01</b>	15	40 07157 62913 5
	1 x	Torsion <b>PH 1</b>	50 mm	E 6,3 10	<b>032 015 01</b>	18	40 07157 62981 4
	1 x	Torsion <b>PH 2</b>	50 mm	E 6,3 10	<b>032 025 01</b>	18	40 07157 62983 8
	1 x	Torsion <b>PH 3</b>	50 mm	E 6,3 10	<b>032 035 01</b>	18	40 07157 62985 2
	2 x	Torsion <b>Torx® 10</b>	25 mm	C 6,3 10	<b>026 102 01</b>	13	40 07157 62921 0
	2 x	Torsion <b>Torx® 15</b>	25 mm	C 6,3 10	<b>026 152 01</b>	13	40 07157 62923 4
	2 x	Torsion <b>Torx® 20</b>	25 mm	C 6,3 10	<b>026 202 01</b>	13	40 07157 62925 8
	2 x	Torsion <b>Torx® 25</b>	25 mm	C 6,3 10	<b>026 252 01</b>	13	40 07157 62927 2
	2 x	Torsion <b>Torx® 30</b>	25 mm	C 6,3 10	<b>026 302 01</b>	15	40 07157 62929 6
	2 x	Torsion <b>Torx® 40</b>	25 mm	C 6,3 10	<b>026 402 01</b>	15	40 07157 62931 9



## Challenger









					 Item No	 EAN-Code
	1 x	<b>PZ 1</b>	25 mm	C 6,3	10 <b>021 010 86</b>	9 40 07157 52185 9
	2 x	<b>PZ 1</b>	25 mm	C 6,3	10 <b>021 012 86</b>	13 40 07157 51033 4
	2 x	<b>PZ 2</b>	25 mm	C 6,3	10 <b>021 022 86</b>	15 40 07157 51035 8
	1 x	<b>PZ 3</b>	25 mm	C 6,3	10 <b>021 030 86</b>	10 40 07157 52187 3
	2 x	<b>PZ 3</b>	25 mm	C 6,3	10 <b>021 032 86</b>	15 40 07157 51037 2
	3 x 1	<b>PZ 1 / PZ 2 / PZ 3</b>	25 mm	C 6,3	10 <b>021 932 86</b>	19 40 07157 52179 8
	1 x	<b>PH 1</b>	25 mm	C 6,3	10 <b>022 010 86</b>	9 40 07157 52181 1
	2 x	<b>PH 2</b>	25 mm	C 6,3	10 <b>022 022 86</b>	13 40 07157 51039 6
	1 x	<b>PH 3</b>	25 mm	C 6,3	10 <b>022 030 86</b>	10 40 07157 52183 5
	3 x 1	<b>PH 1 / PH 2 / PH 3</b>	25 mm	C 6,3	10 <b>022 931 86</b>	19 40 07157 52177 4
	1 x	<b>Torx® 10</b>	25 mm	C 6,3	10 <b>026 100 86</b>	9 40 07157 52189 7
	1 x	<b>Torx® 15</b>	25 mm	C 6,3	10 <b>026 150 86</b>	9 40 07157 52191 0
	1 x	<b>Torx® 20</b>	25 mm	C 6,3	10 <b>026 202 86</b>	9 40 07157 52193 4
	1 x	<b>Torx® 25</b>	25 mm	C 6,3	10 <b>026 252 86</b>	10 40 07157 52195 8
	1 x	<b>Torx® 30</b>	25 mm	C 6,3	10 <b>026 300 86</b>	10 40 07157 52197 2
	1 x	<b>Torx® 40</b>	25 mm	C 6,3	10 <b>026 400 86</b>	11 40 07157 52199 6
	3 x 1	<b>Torx® 15 / Torx® 20 / Torx® 25</b>	25 mm	C 6,3	10 <b>026 933 86</b>	18 40 07157 52175 0



see Page 210/  
siehe Seite 210







### TiN Plus

						Item No		EAN-Code
	2 x	<b>5,0 x 0,8</b>	25 mm	C 6,3	10	<b>020 500 67</b>	15	40 07157 32134 3
	2 x	<b>5,5 x 1,0</b>	25 mm	C 6,3	10	<b>020 520 67</b>	15	40 07157 31892 3
	2 x	<b>6,5 x 1,2</b>	25 mm	C 6,3	10	<b>020 610 67</b>	15	40 07157 31894 7
	2 x	<b>8,0 x 1,2</b>	25 mm	C 6,3	10	<b>020 800 67</b>	16	40 07157 31896 1
	2 x	<b>PZ 1</b>	25 mm	C 6,3	10	<b>021 010 67</b>	15	40 07157 31898 5
	2 x	<b>PZ 2</b>	25 mm	C 6,3	10	<b>021 020 67</b>	15	40 07157 31304 1
	5 x	<b>PZ 2</b>	25 mm	C 6,3	10	<b>021 020 57</b>	30	40 07157 31508 3
	2 x	<b>PZ 3</b>	25 mm	C 6,3	10	<b>021 030 67</b>	15	40 07157 31303 4
	3 x 1	<b>PZ 1 / PZ 2 / PZ 3</b>	25 mm	C 6,3	10	<b>021 932 67</b>	20	40 07157 52171 2
	2 x	<b>PZ 1</b>	50 mm	E 6,3	10	<b>031 015 67</b>	28	40 07157 31910 4
	2 x	<b>PZ 2</b>	50 mm	E 6,3	10	<b>031 025 67</b>	32	40 07157 31912 8
	2 x	<b>PH 1</b>	25 mm	C 6,3	10	<b>022 010 67</b>	15	40 07157 31900 5
	2 x	<b>PH 2</b>	25 mm	C 6,3	10	<b>022 020 67</b>	15	40 07157 31302 7
	5 x	<b>PH 2</b>	25 mm	C 6,3	10	<b>022 020 57</b>	30	40 07157 31494 9
	2 x	<b>PH 3</b>	25 mm	C 6,3	10	<b>022 030 67</b>	15	40 07157 32082 7
	3 x 1	<b>PH 1 / PH 2 / PH 3</b>	25 mm	C 6,3	10	<b>022 931 67</b>	20	40 07157 32142 8
	2 x	<b>PH 1</b>	50 mm	E 6,3	10	<b>032 015 67</b>	28	40 07157 31916 6
	2 x	<b>PH 2</b>	50 mm	E 6,3	10	<b>032 025 67</b>	32	40 07157 31918 0
	2 x	<b>Torx® 10</b>	25 mm	C 6,3	10	<b>026 100 67</b>	15	40 07157 52159 0
	2 x	<b>Torx® 15</b>	25 mm	C 6,3	10	<b>026 150 67</b>	15	40 07157 52161 3
	2 x	<b>Torx® 20</b>	25 mm	C 6,3	10	<b>026 200 67</b>	15	40 07157 52163 7
	2 x	<b>Torx® 25</b>	25 mm	C 6,3	10	<b>026 250 67</b>	15	40 07157 52165 1
	2 x	<b>Torx® 30</b>	25 mm	C 6,3	10	<b>026 300 67</b>	17	40 07157 52167 5
	2 x	<b>Torx® 40</b>	25 mm	C 6,3	10	<b>026 400 67</b>	17	40 07157 52169 9
	3 x 1	<b>Torx® 15 / Torx® 20 / Torx® 25</b>	25 mm	C 6,3	10	<b>026 933 67</b>	20	40 07157 52173 6



**Industrial**

						Item No		EAN-Code
	2 x	<b>3,5 x 0,6</b>	25 mm	C 6,3	10	<b>020 310 36</b>	13	40 07157 10263 8
	2 x	<b>4,0 x 0,8</b>	25 mm	C 6,3	10	<b>020 410 36</b>	15	40 07157 10264 5
	2 x	<b>5,0 x 0,8</b>	25 mm	C 6,3	10	<b>020 500 36</b>	15	40 07157 31890 9
	2 x	<b>5,5 x 0,8</b>	25 mm	C 6,3	10	<b>020 510 36</b>	15	40 07157 10311 6
	2 x	<b>5,5 x 1,0</b>	25 mm	C 6,3	10	<b>020 520 36</b>	15	40 07157 10265 2
	2 x	<b>6,5 x 1,2</b>	25 mm	C 6,3	10	<b>020 610 36</b>	17	40 07157 10266 9
	2 x	<b>8,0 x 1,2</b>	25 mm	C 6,3	10	<b>020 800 36</b>	19	40 07157 10267 6
	2 x	<b>PZ 1</b>	25 mm	C 6,3	10	<b>021 010 36</b>	15	40 07157 10275 1
	5 x	<b>PZ 1</b>	25 mm	C 6,3	10	<b>021 010 56</b>	30	40 07157 31670 7
	2 x	<b>PZ 2</b>	25 mm	C 6,3	10	<b>021 020 36</b>	15	40 07157 10276 8
	5 x	<b>PZ 2</b>	25 mm	C 6,3	10	<b>021 020 56</b>	30	40 07157 10285 0
	2 x	<b>PZ 3</b>	25 mm	C 6,3	10	<b>021 030 36</b>	17	40 07157 10277 5
	5 x	<b>PZ 3</b>	25 mm	C 6,3	10	<b>021 030 56</b>	35	40 07157 31668 4
	3 x 1	<b>PZ 1 / PZ 2 / PZ 3</b>	25 mm	C 6,3	10	<b>021 932 16</b>	21	40 07157 10281 2
	2 x	<b>PZ 1</b>	50 mm	C 6,3	10	<b>021 015 36</b>	30	40 07157 53017 2
	5 x	<b>PZ 1</b>	50 mm	C 6,3	10	<b>021 015 56</b>	60	40 07157 53029 5
	2 x	<b>PZ 2</b>	50 mm	C 6,3	10	<b>021 025 36</b>	32	40 07157 53019 6
	5 x	<b>PZ 2</b>	50 mm	C 6,3	10	<b>021 025 56</b>	65	40 07157 53031 8
	2 x	<b>PZ 3</b>	50 mm	C 6,3	10	<b>021 035 36</b>	34	40 07157 53021 9
	5 x	<b>PZ 3</b>	50 mm	C 6,3	10	<b>021 035 56</b>	40	40 07157 53033 2
	1 x	<b>PZ 4</b>	32 mm	C 6,3	10	<b>021 042 36</b>	18	40 07157 51799 9
	2 x	<b>PZ 1</b>	50 mm	E 6,3	10	<b>031 015 36</b>	28	40 07157 51637 4
	2 x	<b>PZ 2</b>	50 mm	E 6,3	10	<b>031 025 36</b>	32	40 07157 10287 4
2 x	<b>PZ 2</b>	73 mm	E 6,3	10	<b>031 027 36</b>	42	40 07157 10292 8	
3 x 1	<b>PZ 1 / PZ 2 / PZ 3</b>	50 mm	E 6,3	10	<b>031 932 16</b>	41	40 07157 31306 5	
	2 x	<b>PH 1</b>	25 mm	C 6,3	10	<b>022 010 36</b>	15	40 07157 10270 6
	5 x	<b>PH 1</b>	25 mm	C 6,3	10	<b>022 010 56</b>	30	40 07157 31666 0
	2 x	<b>PH 2</b>	25 mm	C 6,3	10	<b>022 020 36</b>	15	40 07157 10271 3
	5 x	<b>PH 2</b>	25 mm	C 6,3	10	<b>022 020 56</b>	30	40 07157 10284 3
	2 x	<b>PH 3</b>	25 mm	C 6,3	10	<b>022 030 36</b>	17	40 07157 10272 0
	5 x	<b>PH 3</b>	25 mm	C 6,3	10	<b>022 030 56</b>	35	40 07157 2833 9
	3 x 1	<b>PH 1 / PH 2 / PH 3</b>	25 mm	C 6,3	10	<b>022 931 16</b>	21	40 07157 10280 5





					Item No		EAN-Code
2 x	<b>PH 1</b>	50 mm	C 6,3	10	<b>022 015 36</b>	30	40 07157 53023 3
5 x	<b>PH 1</b>	50 mm	C 6,3	10	<b>022 015 56</b>	60	40 07157 53035 6
2 x	<b>PH 2</b>	50 mm	C 6,3	10	<b>022 025 36</b>	32	40 07157 53025 7
5 x	<b>PH 2</b>	50 mm	C 6,3	10	<b>022 025 56</b>	65	40 07157 53037 0
2 x	<b>PH 3</b>	50 mm	C 6,3	10	<b>022 035 36</b>	34	40 07157 53027 1
5 x	<b>PH 3</b>	50 mm	C 6,3	10	<b>022 035 56</b>	70	40 07157 53039 4
2 x	<b>PH 1</b>	50 mm	E 6,3	10	<b>032 015 36</b>	30	40 07157 51639 8
2 x	<b>PH 1</b>	73 mm	E 6,3	10	<b>032 017 36</b>	34	40 07157 50520 0
2 x	<b>PH 2</b>	50 mm	E 6,3	10	<b>032 025 36</b>	32	40 07157 10286 7
2 x	<b>PH 2</b>	73 mm	E 6,3	10	<b>032 027 36</b>	42	40 07157 10304 8
3 x 1	<b>PH 1 / PH 2 / PH 3</b>	50 mm	E 6,3	10	<b>032 931 16</b>	42	40 07157 31305 8



2 x	<b>2 mm</b>	25 mm	C 6,3	10	<b>024 200 36</b>	15	40 07157 31880 0
2 x	<b>2,5 mm</b>	25 mm	C 6,3	10	<b>024 250 36</b>	15	40 07157 31882 4
2 x	<b>3 mm</b>	25 mm	C 6,3	10	<b>024 300 36</b>	15	40 07157 31884 8
2 x	<b>4 mm</b>	25 mm	C 6,3	10	<b>024 400 36</b>	15	40 07157 31886 2
5 x	<b>4 mm</b>	25 mm	C 6,3	10	<b>024 400 56</b>	30	40 07157 52867 4
2 x	<b>5 mm</b>	25 mm	C 6,3	10	<b>024 500 36</b>	17	40 07157 10291 1
2 x	<b>6 mm</b>	25 mm	C 6,3	10	<b>024 600 36</b>	19	40 07157 10290 4
2 x	<b>8 mm</b>	25 mm	C 6,3	10	<b>024 800 36</b>	23	40 07157 31888 6



2 x	<b>Torx® 5</b>	25 mm	C 6,3	10	<b>026 050 36</b>	13	40 07157 52865 0
2 x	<b>Torx® 6</b>	25 mm	C 6,3	10	<b>026 060 36</b>	13	40 07157 10303 1
2 x	<b>Torx® 7</b>	25 mm	C 6,3	10	<b>026 070 36</b>	13	40 07157 10302 4
2 x	<b>Torx® 8</b>	25 mm	C 6,3	10	<b>026 080 36</b>	13	40 07157 10301 7
2 x	<b>Torx® 9</b>	25 mm	C 6,3	10	<b>026 090 36</b>	13	40 07157 10300 0
2 x	<b>Torx® 10</b>	25 mm	C 6,3	10	<b>026 100 36</b>	15	40 07157 10299 7
2 x	<b>Torx® 15</b>	25 mm	C 6,3	10	<b>026 150 36</b>	15	40 07157 10298 0
2 x	<b>Torx® 20</b>	25 mm	C 6,3	10	<b>026 200 36</b>	15	40 07157 10297 3
2 x	<b>Torx® 25</b>	25 mm	C 6,3	10	<b>026 250 36</b>	15	40 07157 10296 6
2 x	<b>Torx® 27</b>	25 mm	C 6,3	10	<b>026 270 36</b>	15	40 07157 10295 9
2 x	<b>Torx® 30</b>	25 mm	C 6,3	10	<b>026 300 36</b>	17	40 07157 10294 2
2 x	<b>Torx® 40</b>	25 mm	C 6,3	10	<b>026 400 36</b>	17	40 07157 22194 0
3 x 1	<b>Torx® 10 / Torx® 15 / Torx® 20</b>	25 mm	C 6,3	10	<b>026 931 16</b>	20	40 07157 32222 7
3 x 1	<b>Torx® 15 / Torx® 20 / Torx® 25</b>	25 mm	C 6,3	10	<b>026 933 16</b>	20	40 07157 52157 6
2 x	<b>Torx® 15</b>	50 mm	E 6,3	10	<b>036 155 36</b>	24	40 07157 51867 5
2 x	<b>Torx® 20</b>	50 mm	E 6,3	10	<b>036 205 36</b>	26	40 07157 51869 9
2 x	<b>Torx® 25</b>	50 mm	E 6,3	10	<b>036 255 36</b>	26	40 0715 751871 2
2 x	<b>Torx® 30</b>	50 mm	E 6,3	10	<b>036 305 36</b>	30	40 0715 751875 0
3 x 1	<b>Torx® 10 / Torx® 15 / Torx® 20</b>	50 mm	E 6,3	10	<b>036 931 16</b>	34	40 07157 52243 6
3 x 1	<b>Torx 20 / Torx 25 / Torx 30</b>	50 mm	E 6,3	10	<b>036 932 16</b>	37	40 07157 52241 2



1x	<b>Magnethalter 1/4"</b>	58 mm	E 6,3	10	<b>038 103 96</b>	32	40 07157 10288 1
1x	<b>Socket-Bit 7mm</b>	66 mm	E 6,3	10	<b>039 070 16</b>	36	40 07157 52879 7
1x	<b>Socket-Bit 8mm</b>	66 mm	E 6,3	10	<b>039 080 16</b>	41	40 07157 52881 0
1x	<b>Socket-Bit 10mm</b>	66 mm	E 6,3	10	<b>039 100 16</b>	46	40 07157 52883 4
1x	<b>Socket-Bit 13mm</b>	66 mm	E 6,3	10	<b>039 130 16</b>	64	40 07157 52885 8

**See also page 179**

*Siehe auch Seite 179*

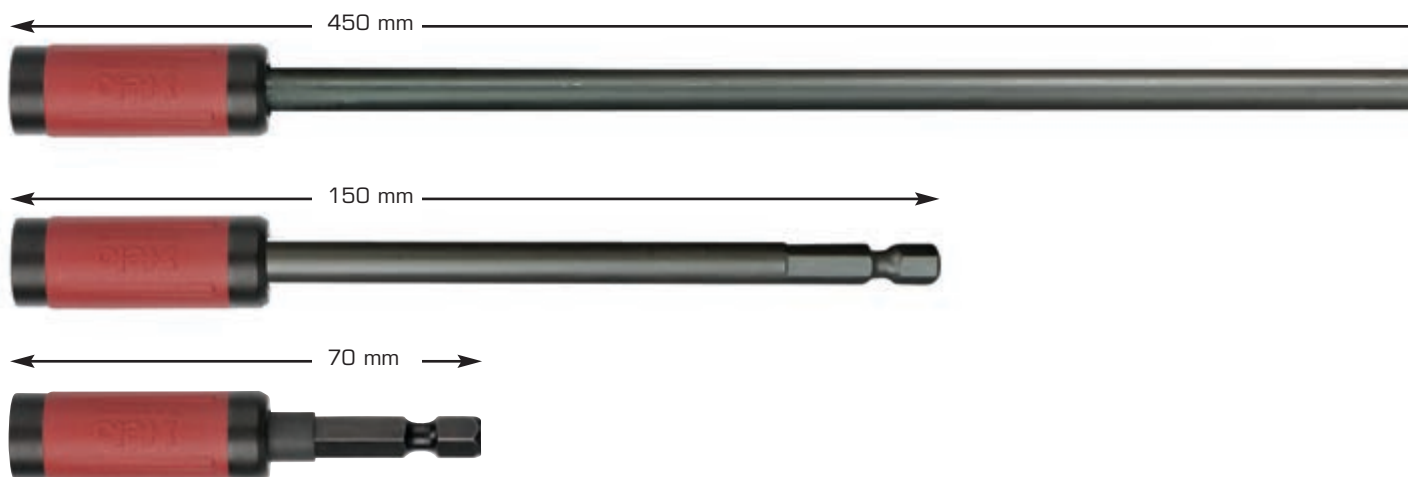

**Face munca mai sigură, mai rapidă și mai eficientă!**

## felo Star

*Biztonságosabb, gyorsabb  
és hatékonyabb munkavégzés!*



**Tubul exterior ce culisează pe un arc al adaptorului automatic STAR are un inel magnetic foarte puternic ce trage capul șuruburilor către vârful bitului, eliminând astfel nevoia de a poziționa manual șuruburile .**

**Aceasta rezultă în siguranță sporită și rezultate perfecte ale operațiilor.**

**Materialele de înaltă calitate și prelucrarea precisă garantează o viață mai lungă a sculei și șuruburilor.**

*A FELO Star automata bittartó egy egyedülálló kiegészítő. Az erős mágnesgyűrű biztonságosan megtartja a csavart - automatikus beállítást végez a csavarfej mélységéhez.*

*Valódi egykezes munkavégzést, gyors és egyszerű bitcserét tesz lehetővé.*

*Kiváló minőségű anyagokból és pontos megmunkálással készült, így garantáljáhozú élettartamot.*

**038**



**felo**  
Innovations



					Item No		EAN-Code
<b>FeloStar</b>	70 mm	E 6,3	1/4"	6	<b>038 165 90</b>	31	40 07157 50799 0
<i>dto on card / auf Karte</i>							
	70 mm	E 6,3	1/4"	6	<b>038 165 94</b>	37	40 07157 52673 1
<b>FeloStar</b>	150 mm	E 6,3	1/4"	6	<b>038 169 90</b>	55	40 07157 51979 5
<b>FeloStar</b>	450 mm	E 6,3	1/4"	4	<b>038 170 90</b>	128	40 07157 60367 8



## TiN 020



felo  
Innovations



Item No



EAN-Code

<b>AllStar TiN Bit Box Universal</b>	C 6,3 x 25 mm	8	<b>020 901 76</b>	147	40 07157 50787 7
<b>Felo Star + 10 TiN Bits</b>					
(2 x ) <b>020:</b>	1,0 x 5,5 / 1,2 x 6,5				
(4 x ) <b>021:</b>	(3 x ) PZ 2 / 3				
(4 x ) <b>022:</b>	(3 x ) PH 2 / 3				
(1 x ) <b>038:</b>	<b>Felo Star Automatic Holder</b> / Felo Star Automatikhalter				



1/4"

## TiN 020



felo  
Innovations



Item No



EAN-Code

<b>AllStar TiN Bit Box Holz</b>	C 6,3 x 25 mm	8	<b>020 902 76</b>	149	40 07157 50789 1
<b>Felo Star + 10 TiN Bits</b>					
(5 x ) <b>021:</b>	(4 x ) PZ 2 / 3				
(5 x ) <b>026:</b>	(2 x ) Torx® 20 / Torx® 25 / Torx® 30 / Torx® 40				
(1 x ) <b>038:</b>	<b>Felo Star Automatic Holder</b> / Felo Star Automatikhalter				



1/4"

## Torsion 020



felo  
Innovations



Item No



EAN-Code

<b>AllStar Torsion Bit Box</b>	C 6,3 x 25 mm	8	<b>020 901 06</b>	147	40 07157 63061 2
<b>Felo Star + 10 Torsion Bits</b>					
(3 x ) <b>021:</b>	(2 x ) PZ 2 / 3				
(3 x ) <b>022:</b>	(2 x ) PH 2 / 3				
(4 x ) <b>026:</b>	Torx® 20 / Torx® 25 / Torx® 30 / Torx® 40				
(1 x ) <b>038:</b>	<b>Felo Star Automatic Holder</b> / Felo Star Automatikhalter				



1/4"

**020**



Item No



EAN-Code

**AllStar Bit Box Universal, C 6,3 x 25 mm**

8 **020 901 16**

146

40 07157 50793 8

**Felo Star + 10 Bits**

(2 x ) **020:** 1,0 x 5,5 / 1,2 x 6,5

(3 x ) **021:** (3 x ) PZ 2 / PZ 3

(3 x ) **022:** (3 x ) PH 2 / PH 3

(1 x ) **038:** **Felo Star Automatic Holder / Felo Star Automatikhalter**



**020**



Item No



EAN-Code

**AllStar Bit Box Holz, C 6,3 x 25 mm**

8 **020 902 16**

147

40 07157 50795 2

**Felo Star + 10 Bits**

(5 x ) **021:** (4 x ) PZ 2 / PZ 3

(5 x ) **026:** (2 x ) Torx® 20 / Torx® 25 / Torx® 30 / Torx® 40

(1 x ) **038:** **Felo Star Automatic Holder / Felo Star Automatikhalter**



**TiN  
026**



Item No



EAN-Code

**AllStar C 6,3 x 25 mm**

8 **020 904 76**

149

40 07157 51011 2

**Felo Star + 10 TiN Bits**

(2 x ) **022:** PH 2

(3 x ) **021:** (2 x ) PZ 2 / PZ 3

(5 x ) **026:** (2 x ) Torx® 20 / Torx® 25 / Torx® 30 / Torx® 40

(1 x ) **038:** **Felo Star Automatic Holder / Felo Star Automatikhalter**





felo  
swift

- Toate mărimile la o singură privire • selecție ușoară a biților (operațiune cu o mână) • funcție auxiliară de șurubelniță
- bármely méret egy pillanat alatt • könnyű bitválasztás (egykezes művelet) • segédcsavarhúzóként is használható



020



	Item No		EAN-Code
<b>TiN Universal Box Swift C 6,3 x 25 mm</b>	10	<b>020 601 76</b>	72 40 07157 51383 0
<b>6 TiN Bits + Bitholder / Magnethalter</b>			
(2 x) <b>020:</b> 1,0 x 5,5 / 1,2 x 6,5			
(2 x) <b>021:</b> PZ 1 / PZ 2			
(2 x) <b>022:</b> PH 1 / PH 2			
(1 x) <b>038:</b> <b>Bitholder / Magnethalter</b>			
<b>PZ TiN Box Swift C 6,3 x 25 mm</b>	10	<b>020 602 76</b>	72 40 07157 51385 4
<b>6 TiN Bits + Bitholder / Magnethalter</b>			
(2 x) <b>021:</b> PZ 1			
(3 x) <b>021:</b> PZ 2			
(1 x) <b>021:</b> PZ 3			
(1 x) <b>038:</b> <b>Bitholder / Magnethalter</b>			



## TiN 020



**PH - PZ TiN Box Swift C 6,3 x 25 mm**



10 **020 603 76**



72

**EAN-Code**

40 07157 51387 8

**6 TiN Bits + Bitholder / Magnethalter**



{3 x } **021:** PZ 1 / PZ 2 / PZ 3

{3 x } **022:** PH 1 / PH 2 / PH 3

{1 x } **038:** **Bitholder / Magnethalter**

**dto. on card / auf Karte**

10 **020 603 71**

84

40 07157 52729 5



**Torx TiN Box Swift C 6,3 x 25 mm**

10 **020 604 76**

73

40 07157 51389 2

**6 TiN Bits + Bitholder / Magnethalter**

{6 x } **026:** Torx® 10 / Torx® 15 / Torx® 20 / Torx® 25 / Torx® 30 / Torx® 40

{1 x } **038:** **Bitholder / Magnethalter**

**dto. on card / auf Karte**

10 **020 604 71**

84

40 07157 52731 8



**Swift TiN Bit-Box C 6,3 x 25 mm**

10 **020 605 76**

71

40 07157 51411 0

**6 TiN Bits + Bitholder / Magnethalter**



{3 x } **021:** PZ 1 / PZ 2 / PZ 3

{3 x } **026:** Torx® 15 / Torx® 20 / Torx® 25

{1 x } **038:** **Bitholder / Magnethalter**



**Diamant Swift Bit-Box C 6,3 x 25 mm**

10 **020 603 86**

70

40 07157 51707 4

**6 Diamant Bits + Bitholder / Magnethalter**



{3 x } **021:** PZ 1 / PZ 2 / PZ 3

{3 x } **022:** PH 1 / PH 2 / PH 3

{1 x } **038:** **Bitholder / Magnethalter**





## 020



			Item No		EAN-Code
	<b>Box Swift C 6,3 x 25 mm</b>	10	<b>020 601 16</b>	72	40 07157 51391 5
	<b>6 Bits + Bitholder / Magnethalter</b>				
	(2 x) <b>020:</b> 1,0 x 5,5 / 1,2 x 6,5				
	(2 x) <b>021:</b> PZ 1 / PZ 2				
	(2 x) <b>022:</b> PH 1 / PH 2				
	(1 x) <b>038:</b> <b>Bitholder / Magnethalter</b>				
	<b>PZ Box Swift C 6,3 x 25 mm</b>	10	<b>020 602 16</b>	72	40 07157 51393 9
	<b>6 Bits + Bitholder / Magnethalter</b>				
	(2 x) <b>021:</b> PZ 1				
	(3 x) <b>021:</b> PZ 2				
	(1 x) <b>021:</b> PZ 3				
	(1 x) <b>038:</b> <b>Bitholder / Magnethalter</b>				
	<b>Torx Box Swift C 6,3 x 25 mm</b>	10	<b>020 603 16</b>	73	40 07157 51395 3
	<b>6 Bits + Bitholder / Magnethalter</b>				
	(6 x) <b>026:</b> Torx® 10 / Torx® 15 / Torx® 20 / Torx® 25 / Torx® 30 / Torx® 40				
	(1 x) <b>038:</b> <b>Bitholder / Magnethalter</b>				
	<b>PZ/PH Swift Box C 6,3 x 25 mm</b>	10	<b>020 603 26</b>	72	40 07157 51689 3
	<b>6 Bits + Bitholder / Magnethalter</b>				
	(3 x) <b>021:</b> PZ 1 / PZ 2 / PZ 3				
	(3 x) <b>022:</b> PH 1 / PH 2 / PH 3				
	(1 x) <b>038:</b> <b>Bitholder / Magnethalter</b>				



**felo**  
Innovations

## 020









			Item No		EAN-Code
	<b>Bit-Tool on blister / in Blister C 6,3 x 25 mm</b>	10	<b>020 801 06</b>	152	40 07157 63427 6
	<b>8 Bits + Bitholder / Magnethalter</b>				
	(1 x) <b>020:</b> 0,8 x 5,5				
	(1 x) <b>021:</b> PZ 2				
	(3 x) <b>022:</b> PH 1 / PH 2 / PH 3				
	(3 x) <b>026:</b> Torx® 15 / Torx® 20 / Torx® 25				
	(1 x) <b>038:</b> <b>Bitholder / Magnethalter (58 mm)</b>				

1/4"













## Torsion 020

			Item No		EAN-Code
	<b>Torx</b> Torsion <b>Box Swift</b> C 6,3 x 25 mm	10	<b>020 601 06</b>	68	40 07157 63043 8
	<b>6</b> Torsion <b>Bits + Bitholder / Magnethalter</b>				
	[6 x ] <b>026:</b> Torx® 10 / Torx® 15 / Torx® 20 / Torx® 25 / Torx® 30 / Torx® 40				
	[1 x ] <b>038:</b> <b>Bitholder / Magnethalter</b>				
	<b>PZ / Torx</b> Torsion <b>Box Swift</b> C 6,3 x 25 mm	10	<b>020 602 06</b>	68	40 07157 63045 2
	<b>6</b> Torsion <b>Bits + Bitholder / Magnethalter</b>				
	[3 x ] <b>021:</b> PZ 1 / PZ 2 / PZ 3				
	[3 x ] <b>026:</b> Torx® 15 / Torx® 20 / Torx® 25				
	[1 x ] <b>038:</b> <b>Bitholder / Magnethalter</b>				
	<b>PZ</b> Torsion <b>Box Swift</b> C 6,3 x 25 mm	10	<b>020 603 06</b>	67	40 07157 63047 6
	<b>6</b> Torsion <b>Bits + Bitholder / Magnethalter</b>				
	[2 x ] <b>021:</b> PZ 1				
	[3 x ] <b>021:</b> PZ 2				
	[1 x ] <b>021:</b> PZ 3				
	[1 x ] <b>038:</b> <b>Bitholder / Magnethalter</b>				
	<b>PH</b> Torsion <b>Box Swift</b> C 6,3 x 25 mm	10	<b>020 604 06</b>	67	40 07157 63049 0
	<b>6</b> Torsion <b>Bits + Bitholder / Magnethalter</b>				
	[2 x ] <b>022:</b> PH 1				
	[3 x ] <b>022:</b> PH 2				
	[1 x ] <b>022:</b> PH 3				
	[1 x ] <b>038:</b> <b>Bitholder / Magnethalter</b>				





## Impact 020

			Item No		EAN-Code
	<b>Universal Impact Box Swift</b> C 6,3 x 25 mm	10	<b>020 601 46</b>	66	40 07157 63051 3
	<b>6 Impact Bits + Bitholder / Magnethalter</b>				
	{2 x } <b>021:</b> PZ 1 / PZ 2				
	{1 x } <b>022:</b> PH 2				
	{3 x } <b>026:</b> Torx® 15 / Torx® 20 / Torx® 25				
	{1 x } <b>038:</b> <b>Bitholder / Magnethalter</b>				
	<b>PZ / Torx Impact Box Swift</b> C 6,3 x 25 mm	10	<b>020 602 46</b>	68	40 07157 63053 7
	<b>6 Impact Bits + Bitholder / Magnethalter</b>				
	{3 x } <b>021:</b> PZ 1 / PZ 2 / PZ 3				
	{3 x } <b>026:</b> Torx® 15 / Torx® 20 / Torx® 25				
	{1 x } <b>038:</b> <b>Bitholder / Magnethalter</b>				
	<b>Torx Impact Box Swift</b> C 6,3 x 25 mm	10	<b>020 603 46</b>	68	40 07157 63055 1
	<b>6 Impact Bits + Bitholder / Magnethalter</b>				
	{6 x } <b>026:</b> Torx® 10 / Torx® 15 / Torx® 20 / Torx® 25 / Torx® 30 / Torx® 40				
	{1 x } <b>038:</b> <b>Bitholder / Magnethalter</b>				
	<b>PZ Impact Box Swift</b> C 6,3 x 25 mm	10	<b>020 604 46</b>	67	40 07157 63057 5
	<b>6 Impact Bits + Bitholder / Magnethalter</b>				
	{2 x } <b>021:</b> PZ 1				
	{3 x } <b>021:</b> PZ 2				
	{1 x } <b>021:</b> PZ 3				
	{1 x } <b>038:</b> <b>Bitholder / Magnethalter</b>				
	<b>PH Impact Box Swift</b> C 6,3 x 25 mm	10	<b>020 605 46</b>	67	40 07157 63059 9
	<b>6 Impact Bits + Bitholder / Magnethalter</b>				
	{2 x } <b>022:</b> PH 1				
	{3 x } <b>022:</b> PH 2				
	{1 x } <b>022:</b> PH 3				
	{1 x } <b>038:</b> <b>Bitholder / Magnethalter</b>				



## 020



Item No



EAN-Code

<b>Bits 30</b> (28 x )	<b>30-pcs. / 30-tlg.</b> <b>Bits</b> C6,3 x 25 mm 3,0 x 0,5 / 4,5 x 0,6 / 5,5 x 0,8 / 6,5 x 1,2 2 mm / 3 mm / 4 mm / 5 mm / 6 mm PZ 1 / PZ 2 / PZ 3 PH 0 / PH 1 / PH 2 / PH 3 Torx® 5 / Torx® 6 / Torx® 7 / Torx® 8 / Torx® 10 / Torx® 15 / Torx® 20 / Torx® 25 / Torx® 30 / Torx® 40 Spanner 6 / Spanner 8 <b>ERGONIC Stubby 1/4"</b> <b>Bitholder / Bithalter</b> E6,3 x 58 mm <b>StrongBox</b> 135 x 75 x 37 mm	1	<b>020 730 06</b>	334	40 07157 61563 3
---------------------------	--	---	-------------------	-----	------------------



1/4"

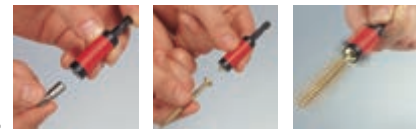

## 020



Item No



EAN-Code

<b>Bits 38</b> (36 x )	<b>38-pcs. / 38-tlg.</b> <b>Bits</b> C6,3 x 25 mm 4,5 x 0,6 / 6,5 x 1,2 2 mm / 3 mm / 4 mm / 5 mm / 6 mm 2 x PZ 1 / 5 x PZ 2 / 2 x PZ 3 PH 0 / 2 x PH 1 / 4 x PH 2 / 2 x PH 3 Torx® 6 / Torx® 7 / Torx® 8 / Torx® 10 / Torx® 15 / Torx® 20 / Torx® 25 / Torx® 30 / Torx® 40 SQ 1 / SQ 2 <b>Felo Star Automatic-Holder / Felo Star Automatischer Bithalter</b> <b>Bitholder / Bithalter</b> E6,3 x 58 mm <b>StrongBox</b> 135 x 75 x 37 mm	1	<b>020 738 06</b>	346	40 07157 61565 7
---------------------------	---	---	-------------------	-----	------------------



1/4"



## 020



Item No



EAN-Code

<b>Bits 35</b> (28 x )	<b>35-pcs. / 35-tlg.</b> <b>Bits</b> C6,3 x 25 mm 4,5 x 0,6 / 5,5 x 0,8 / 6,5 x 1,2 3 mm / 4 mm / 5 mm PH 0 / 2 x PH 1 / 2 x PH 2 / PH 3 2 x PZ 1 / 3 x PZ 2 / PZ 3 Torx® 5 / Torx® 6 / Torx® 7/ Torx® 8/ Torx® 10 / Torx® 15 / Torx® 20 / Torx® 25 / Torx® 30 / Torx® 40	1	<b>020 735 16</b>	365	40 07157 61567 1
(6 x )	<b>Bits</b> E6,3 x 50 mm PZ 1 / PZ 2 PH 2 Torx® 20 / Torx® 25/ Torx® 30				
	<b>Bitholder / Bithalter</b> E6,3 x 58 mm				
	<b>StrongBox</b> 135 x 75 x 37 mm				



<b>Bits 35 Torx®</b> (28 x )	<b>35-pcs. / 35-tlg.</b> <b>Bits</b> C6,3 x 25 mm 1 x Torx® 5 / 1 x Torx® 6 / 1 x Torx® 7 / 1 x Torx® 8 / 1 x Torx® 9 2 x Torx® 10 / 4 x Torx® 15 / 4 x Torx® 20 / 4 x Torx® 25 1 x Torx® 27 / 4 x Torx® 30 / 4 x Torx® 40	1	<b>020 735 26</b>	365	40 07157 63529 7
(6 x )	<b>Bits</b> E6,3 x 50mm Torx® 10 / Torx® 15 / Torx® 20 / Torx® 25 / Torx® 30 / Torx® 40				
	<b>Bitholder / Bithalter</b> E6,3 x 58 mm				
	<b>StrongBox</b> 135 x 75 x 37 mm				







See also page 131 /  
siehe auch Seite 131



## 020



			Item No		EAN-Code
<b>IMPACT 19</b>	<b>19-pcs. / 19-tlg.</b>	1	<b>020 719 46</b>	262	40 07157 63187 9
(18 x )	<b>IMPACT Bits</b> C6,3 x 25mm				
	1 x PZ 1 / 2 x PZ 2 / 2 x PZ 3				
	1 x PH 1 / 2 x PH 2 / 2 x PH 3				
	1 x Torx® 10 / 1 x Torx® 15 / 1 x Torx® 20				
	2 x Torx® 25 / 2 x Torx® 30 / 1 x Torx® 40				
	<b>Bitholder IMPACT</b> / <i>Bithalter IMPACT</i> E6,3 x 58 mm				
	<b>StrongBox</b> 135 x 75 x 37 mm				





<b>Bitbox IMPACT 19 Industry</b>	<b>19-pcs. / 19-tlg.</b>	1	<b>020 719 06</b>	260	40 07157 63555 6
(18 x )	<b>Industry Bits</b> C6,3 x 25 mm				
	1 x PZ 1 / 2 x PZ 2 / 2 x PZ 3				
	1 x PH 1 / 2 x PH 2 / 2 x PH 3				
	1 x Torx® 10 / 1 x Torx® 15 / 1 x Torx® 20				
	2 x Torx® 25 / 2 x Torx® 30 / 1 x Torx® 40				
	<b>Bitholder IMPACT</b> / <i>Bithalter IMPACT</i> E6,3 x 58mm				
	<b>StrongBox</b> 135 x 75 x 37 mm				



## 020



			Item No		EAN-Code
<b>Bit-Tool IMPACT on blister</b>	<b>/ in Blister</b> C 6,3 x 25 mm	10	<b>020 802 46</b>	193	40 07157 63429 0
	<b>8 Bits + IMPACT Bitholder + Bitholder</b> / <i>IMPACT Bithalter + Magnethalter</i>				
(1 x )	<b>026:</b> Torx® 10				
(1 x )	<b>026:</b> Torx® 15				
(1 x )	<b>026:</b> Torx® 20				
(2 x )	<b>026:</b> Torx® 25				
(2 x )	<b>026:</b> Torx® 30				
(1 x )	<b>026:</b> Torx® 40				
(1 x )	<b>038:</b> <b>IMPACT Bitholder</b> / <i>Bithalter</i>				
(1 x )	<b>038:</b> <b>Bitholder</b> / <i>Magnethalter</i> (58 mm)				

## Impact 036



**Profi Bit Box Impact,**



**Item No**



**EAN-Code**

10

**036 915 46**

65

40 07157 63063 6

**6 Impact Bits** E 6,3 x 50 mm

(6 x ) **036:** Torx® 10 / Torx® 15 / Torx® 20 / Torx® 25 / Torx® 30 / Torx® 40



**Profi Bit Box Impact,**

10

**036 925 46**

65

40 07157 63065 0

**6 Impact Bits** E 6,3 x 50 mm

(2 x ) **031:** PZ 1 / PZ 2

(1 x ) **032:** PH 2

(3 x ) **036:** Torx® 15 / Torx® 20 / Torx® 25



**Profi Bit Box Impact,**

10

**036 935 46**

65

40 07157 63067 4

**6 Impact Bits** E 6,3 x 50 mm

(1 x ) **031:** PZ 2

(1 x ) **032:** PH 2

(4 x ) **036:** Torx® 15 / Torx® 20 / Torx® 25 / Torx® 30



**Profi Bit Box Impact,**

10

**036 945 46**

66

40 07157 63425 2

**6 Impact Bits** E 6,3 x 50 mm

(2 x ) **031:** PZ 2 / 3

(4 x ) **036:** Torx® 15 / Torx® 20 / Torx® 25 / Torx® 30



## TiN 020



**Profi Bit Box, 12TiN Bits + Bitholder** C 6,3 x 25 mm



**Item No**



**EAN-Code**

10

**020 917 16**

107

40 07157 31445 1

(4 x ) **020:** 0,8 x 5,0 / 1,0 x 5,5 / 1,2 x 6,5 / 1,2 x 8,0

(2 x ) **021:** PZ 1 / PZ 3

(2 x ) **021:** PZ 2

(2 x ) **022:** PH 1 / 3



(2 x ) **022:** PH 2

(1 x ) **038:** **Bitholder** / *Magnethalter 58 mm*



## TiN 021





			Item No		EAN-Code
<b>Profi Bit Box, 12TiN Bits + Bitholder C 6,3 x 25 mm</b>		10	<b>021 910 76</b>	104	40 07157 31537 3
(2 x ) <b>021:</b>	PZ 1				
(8 x ) <b>021:</b>	PZ 2				
(2 x ) <b>021:</b>	PZ 3				
(1 x ) <b>038:</b>	<b>Bitholder / Magnethalter 58 mm</b>				



<b>Profi Bit Box, 12TiN Bits + Bitholder C 6,3 x 25 mm</b>		10	<b>022 910 76</b>	104	40 07157 31408 6
(2 x ) <b>021:</b>	PZ 1				
(3 x ) <b>021:</b>	PZ 2				
(1 x ) <b>021:</b>	PZ 3				
(2 x ) <b>022:</b>	PH 1				
(3 x ) <b>022:</b>	PH 2				
(1 x ) <b>022:</b>	PH 3				
(1 x ) <b>038:</b>	<b>Bitholder / Magnethalter 58 mm</b>				



## TiN 032



			Item No		EAN-Code
<b>Profi Bit Box, 6 TiN Bits E 6,3 x 50 mm</b>		10	<b>032 915 76</b>	79	40 07157 31413 0
(3 x ) <b>031:</b>	PZ 1 / PZ 2 / PZ 3				
(3 x ) <b>032:</b>	PH 1 / PH 2 / PH 3				



## TiN 036



			Item No		EAN-Code
<b>Profi Bit Box, 6 TiN Bits E 6,3 x 50 mm</b>		10	<b>036 915 76</b>	75	40 07157 32384 2
(6 x ) <b>036:</b>	Torx® 10 / Torx® 15 / Torx® 20 Torx® 25 / Torx® 30 / Torx® 40				

## 020



			Item No		EAN-Code
<b>Profi Bit Box, 12 Bits + Bitholder</b> C 6,3 x 25 mm		10	<b>020 910 16</b>	107	40 07157 31405 5
(4 x) <b>020:</b>	0,8 x 5,0 / 1,0 x 5,5 / 1,2 x 6,5 / 1,2 x 8,0				
(2 x) <b>021:</b>	PZ 1 / PZ 3				
(2 x) <b>021:</b>	PZ 2				
(2 x) <b>022:</b>	PH 1 / PH 3				
(2 x) <b>022:</b>	PH 2				
(1 x) <b>038:</b>	<b>Bitholder</b> / <i>Magnethalter 58 mm</i>				



## 022



			Item No		EAN-Code
<b>Profi Bit Box, 12 Bits + Bitholder</b> C 6,3 x 25 mm		10	<b>022 910 16</b>	104	40 07157 31407 9
(2 x) <b>021:</b>	PZ 1				
(3 x) <b>021:</b>	PZ 2				
(1 x) <b>021:</b>	PZ 3				
(2 x) <b>022:</b>	PH 1				
(3 x) <b>022:</b>	PH 2				
(1 x) <b>022:</b>	PH 3				
(1 x) <b>038:</b>	<b>Bitholder</b> / <i>Magnethalter 58 mm</i>				

## 026



			Item No		EAN-Code
<b>Profi Bit Box, 12 Bits + Bitholder</b> C 6,3 x 25 mm		10	<b>026 910 16</b>	104	40 07157 31409 3
(10 x) <b>026:</b>	Torx® 6 / Torx® 7 / Torx® 8 / Torx® 9 / Torx® 10 / Torx® 15 / Torx® 20 / Torx® 27 / Torx® 30 / Torx® 40				
(2 x) <b>026:</b>	Torx® 25				
(1 x) <b>038:</b>	<b>Bitholder</b> / <i>Magnethalter 58 mm</i>				



## 030





		Item No		EAN-Code
<b>Profi Bit Box, 6 Bits</b> E 6,3 x 50 mm	10	<b>030 915 16</b>	78	40 07157 31410 9
[6 x ] <b>030:</b>		0,6 x 3,5 / 0,8 x 4,0 / 0,8 x 5,0		
		1,0 x 5,5 / 1,2 x 6,5 / 1,2 x 8,0		



## 032





		Item No		EAN-Code
<b>Profi Bit Box, 6 Bits</b> E6,3 x 50 mm	10	<b>032 915 16</b>	78	40 07157 31412 3
[3 x ] <b>031:</b>		PZ 1 / PZ 2 / PZ 3		
[3 x ] <b>032:</b>		PH 1 / PH 2 / PH 3		



## 036



		Item No		EAN-Code
<b>Profi Bit Box, 6 Bits</b> E 6,3 x 50 mm	10	<b>036 915 16</b>	75	40 07157 31419 2
[6 x ] <b>036:</b>		Torx® 10 / Torx® 15 / Torx® 20		
		Torx® 25 / Torx® 30 / Torx® 40		







**Assortments for Electricians/  
Sortimente für Elektriker**

**030**





		Item No		EAN-Code
<b>Profi Bit Box, 6 Bits</b> E 6,3 x 50 mm	10	<b>030 925 16</b>	75	40 07157 63075 9
(3 x) <b>030:</b>		0,5 x 3,0 / 0,8 x 4,0 / 5,5 x 1,0		
(1 x) <b>031:</b>		PZ 2		
(2 x) <b>032:</b>		PH 1 / PH 2		



**Assortments for Electricians/  
Sortimente für Elektriker**

**030**



		Item No		EAN-Code
<b>Profi Bit Box, 6 Bits</b> E 6,3 x 73 mm	10	<b>030 927 16</b>	100	40 07157 63069 8
(3 x) <b>030:</b>		0,5 x 3,0 / 0,8 x 4,0 / 5,5 x 1,0		
(1 x) <b>031:</b>		PZ 2		
(2 x) <b>032:</b>		PH 1 / PH 2		





**Assortments for Electricians/  
Sortimente für Elektriker**



**031**



		Item No		EAN-Code
<b>Profi Bit Box, 6 Bits</b> E 6,3 x 73 mm	10	<b>031 927 16</b>	100	40 07157 63071 1
(3 x) <b>030:</b>		0,5 x 3,0 / 0,8 x 4,0 / 5,5 x 1,0		
(2 x) <b>031:</b>		Z(+/-) 1 / Z(+/-) 2		
(1 x) <b>032:</b>		PH 2		





## Assortments for Electricians/ Sortimente für Elektriker



### 032





		Item No		EAN-Code
<b>Profi Bit Box, 6 Bits</b> E 6,3 x 73 mm	10	<b>032 927 16</b>	100	40 07157 63071 1
[3 x] <b>030:</b>		0,5 x 3,0 / 0,8 x 4,0 / 5,5 x 1,0		
[2 x] <b>031:</b>		H(+/-) 1 / H(+/-) 2		
[1 x] <b>032:</b>		PH 2		



### 030





		Item No		EAN-Code
<b>Profi Bit Box, 5 Bits</b> E 6,3 x 73 mm	10	<b>030 917 16</b>	83	40 07157 31411 6
[5 x] <b>030:</b>		0,5 x 3,0 / 0,6 x 3,5 / 0,8 x 4,0 1,0 x 5,5 / 1,2 x 6,5		



### 032



		Item No		EAN-Code
<b>Profi Bit Box, 6 Bits</b> E 6,3 x 73 mm	10	<b>032 917 16</b>	112	40 07157 31385 0
[3 x] <b>031:</b>		PZ 1 / PZ 2 / PZ 3		
[3 x] <b>032:</b>		PH 1 / PH 2 / PH 3		



**036**



	Item No	EAN-Code
<b>Profi Bit Box, 6 Bits</b> E 6,3 x 73 mm	10 <b>036 917 16</b>	100 40 07157 31417 8
[6 x ] <b>036:</b>	Torx® 10 / Torx® 15 / Torx® 20 Torx® 25 / Torx® 30 / Torx® 40	



**020**



	Item No	EAN-Code
<b>Schraub-Box, 9 Bits + Bitholder</b> C 6,3 x 25 mm	6 <b>020 995 06</b>	110 40 07157 30158 1
[3 x ] <b>020:</b>	0,8 x 5,0 / 1,0 x 5,5 / 1,2 x 7,0	
[3 x ] <b>021:</b>	PZ 1 / PZ 2 / PZ 3	
[3 x ] <b>022:</b>	PH 1 / PH 2 / PH 3	
[1 x ] <b>038:</b>	<b>Bitholder</b> / <i>Magnethalter 58 mm</i>	



**057**





	Item No	EAN-Code
<b>1/4" Nuss-Box, 8 Steckschlüssel + Adapter</b>	6 <b>057 981 06</b>	172 40 07157 22198 8
[8 x ]	4 mm / 5 mm / 5,5 mm / 6 mm / 7 mm 8 mm / 10 mm / 13 mm	
[1 x ] <b>097:</b>	<b>Adapter</b> (Art.No. 097 013 10)	



## 020





			Item No		EAN-Code
<b>Bit Box, 25 Bits + Bitholder</b> C 6,3 x 25 mm		6	<b>020 026 16</b>	196	40 07157 50801 0
(10 x) <b>026:</b>	Torx® 6 / Torx® 8 / Torx® 9 / Torx® 10 / Torx® 15 / Torx® 20 / Torx® 25 / Torx® 27 / Torx® 30 / Torx® 40				
(3 x) <b>021:</b>	PZ 1 / PZ 2 / PZ 3				
(3 x) <b>022:</b>	PH 1 / PH 2 / PH 3				
(3 x) <b>020:</b>	0,8 x 4,0 / 1,0 x 5,5 / 1,2 x 6,5				
(6 x) <b>024:</b>	2,0 mm / 2,5 mm / 3,0 mm / 4,0 mm / 5,0 mm / 6,0 mm				
(1 x) <b>038:</b>	<b>Bitholder</b> / <i>Magnethalter 58 mm</i>				



## 020





			Item No		EAN-Code
<b>Bit Box Holz, 25 Bits + Bitholder</b> C 6,3 x 25 mm		6	<b>020 126 16</b>	195	40 07157 50805 8
(5 x) <b>026:</b>	Torx® 10 / Torx® 15 / Torx® 27 / Torx® 30 / Torx® 40				
(2 x 3)	Torx® 20 / Torx® 25				
(2 x 3) <b>021:</b>	PZ 1 / PZ 3				
(8 x)	PZ 2				
(1 x) <b>038:</b>	<b>Bitholder</b> / <i>Magnethalter 58 mm</i>				



## 021



			Item No		EAN-Code
<b>Bit Box PZ, 25 Bits + Bitholder</b> C 6,3 x 25 mm		6	<b>021 026 16</b>	194	40 07157 50807 2
(2 x) <b>021:</b>	PZ 0				
(8 x)	PZ 1				
(12 x)	PZ 2				
(3 x)	PZ 3				
(1 x) <b>038:</b>	<b>Bitholder</b> / <i>Magnethalter 58 mm</i>				



## 020



Item No



EAN-Code

	6	020 326 16	196	40 07157 51565 0
<b>Security Bit Box + Bitholder</b>				
(2 x ) <b>024:</b>		SW 4,0 / 3,0		
(3 x ) <b>028:</b>		XZN M6 / XZN M5 / XZN M4		
(5 x ) <b>029:</b>		TS 10 / TS 8 / TS 6 / TS 4 / TS 0		
(5 x ) <b>027:</b>		Torx®TR 30 / Torx®TR 25 / Torx®TR 20 / Torx®TR 15 / Torx®TR 10		
(5 x ) <b>029:</b>		Tri-Wing 5 / 4 / 3 / 2 / 1		
(3 x ) <b>020:</b>		Spanner 6 / 8 / 10		
(2 x ) <b>028:</b>		Clutch 5/32, 1/4		
(1 x ) <b>038:</b>		<b>Bitholder</b> / <i>Magnethalter 58 mm</i>		



## 020



Item No



EAN-Code

	10	020 974 60	95	40 07157 30141 3
<b>Bit-Box, 6 Bits + Bitholder</b> C 6,3 x 25 mm				
(2 x ) <b>020:</b>		0,8 x 5,0 / 1,2 x 7,0		
(2 x ) <b>021:</b>		PZ 1 / PZ 2		
(2 x ) <b>022:</b>		PH 1 / PH 2		
(1 x ) <b>038:</b>		<b>Bitholder</b> / <i>Magnethalter 58 mm</i>		
<b>Torx-Box, 6 Bits + Bitholder</b> C 6,3 x 25 mm				
(6 x ) <b>026:</b>		Torx® 10 / Torx® 15 / Torx® 20 Torx® 25 / Torx® 30 / Torx® 40		
(1 x ) <b>038:</b>		<b>Bitholder</b> / <i>Magnethalter 58 mm</i>		
<b>dto. on card / auf Karte</b>				
	10	<b>023 974 61</b>	104	40 07157 30252 6

## Biți Speciali & Adaptorii

### Különleges bitek és átalakítók

**029  
C 6,3**



**felo**  
Innovations



LocTec®	→	↕	↕	↕	Item No	📦	EAN-Code
<b>15-LID</b>	25	C 6,3	1/4"	10	<b>029 300 10</b>	5	40 07157 60379 1
<b>20-LID</b>	25	C 6,3	1/4"	10	<b>029 400 10</b>	5	40 07157 60381 4
<b>25-LID</b>	25	C 6,3	1/4"	10	<b>029 500 10</b>	6	40 07157 60383 8
<b>30-LID</b>	25	C 6,3	1/4"	10	<b>029 600 10</b>	6	40 07157 60385 2

**079  
C 8**



**felo**  
Innovations



LocTec®	→	↕	↕	↕	Item No	📦	EAN-Code
<b>45-LID</b>	30	C 8	5/16"	10	<b>079 080 10</b>	11	40 07157 60389 0
<b>50-LID</b>	30	C 8	5/16"	10	<b>079 100 10</b>	11	40 07157 60387 6

### Înșurubare Csak befelé

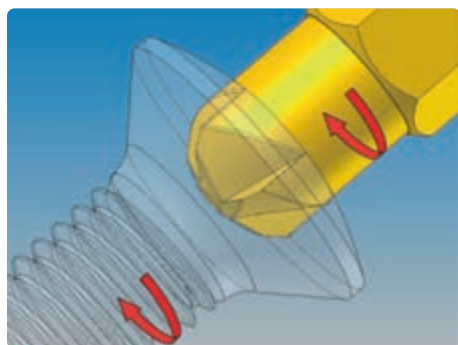

Înșurubați pur și simplu șurubul LocTec® cu bitul autoblocabil. Nu mai sunt necesare alte măsuri suplimentare de blocare ale șurubului.

Egyszerűen csavarja be a LocTec® csavart.  
Nincs szükség egyéb rögzítési intézkedésekre.  
Oldhatatlan kötést biztosít.

### Încercare de desfiletare a șurubului Hiába próbálja meglazítani a csavart

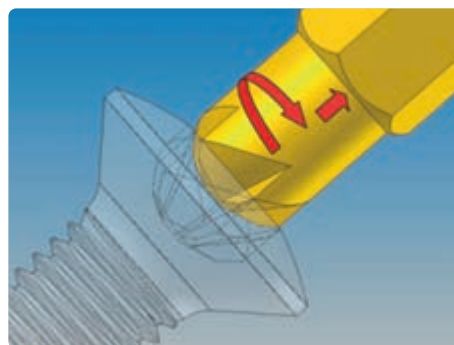

Geometria specială a bitului asigură imposibilitatea oricărei încercări de a desface șurubul-chiar și cu ajutorul bitului LocTec®-deoarece acesta va fi aruncat din șurub.

A különleges geometria biztosítja, hogy a csavar lazításának minden kísérlete - még a rögzítő bit használatával is - meghiúsuljon

**For more information visit /**

Mehr Information unter:

[www.arnold-umformtechnik.de](http://www.arnold-umformtechnik.de)

## 039 E 6,3



See also page 157

Siehe auch Seite 157



mm				Item No		EAN-Code
5	66 mm	E 6,3 1/4"	5	<b>039 050 10</b>	28	40 07157 50404 3
6	66 mm	E 6,3 1/4"	5	<b>039 060 10</b>	27	40 07157 50406 7
7	66 mm	E 6,3 1/4"	5	<b>039 070 10</b>	26	40 07157 51373 1
8	66 mm	E 6,3 1/4"	5	<b>039 080 10</b>	31	40 07157 50408 1
9	66 mm	E 6,3 1/4"	5	<b>039 090 10</b>	33	40 07157 53245 9
10	66 mm	E 6,3 1/4"	5	<b>039 100 10</b>	36	40 07157 50410 4
11	66 mm	E 6,3 1/4"	5	<b>039 110 10</b>	36	40 07157 53247 3
12	66 mm	E 6,3 1/4"	5	<b>039 120 10</b>	39	40 07157 53249 7
13	66 mm	E 6,3 1/4"	5	<b>039 130 10</b>	54	40 07157 50412 8

## 039 E 6,3



				Item No		EAN-Code
5/16"	66 mm	E 6,3 1/4"	5	<b>039 516 10</b>	31	40 07157 50414 2
3/8"	66 mm	E 6,3 1/4"	5	<b>039 038 10</b>	36	40 07157 50416 6

## 039 E 6,3



	Item No		EAN-Code
1	<b>039 961 06</b>	550	40 07157 63841 0

Nutdriver Bit Set 6-pce. /

Steckschlüsselbit-Set 6-tlg.

6 / 7 / 8 / 10 / 12 / 13 mm

### Biți speciali pentru potrivirea perfectă

Különleges bitek, egyedi csatlakozással

<p><b>A5,5</b></p> <p>AEG BOSCH HOLZ-HER KRESS METABO</p>	<p><b>G7</b></p> <p>BAIER FEIN</p>	<p><b>C8</b></p> <p>BOSCH FEIN HOLZ-HER LEUREUX METABO</p>	<p><b>M5</b></p> <p>BÖLLHOFF/ UNIQUICK HOLZ-HER WEBER</p>	<p><b>10/32" NFA</b></p> <p>USM DUOFAST DVSG</p>
---	--	--	---	--

## 011 A5,5



PZ					Item No		EAN-Code
2	50 mm	A 5,5	5,5 mm	10	<b>011 025 10</b>	10	40 07157 30021 8
3	50 mm	A 5,5	5,5 mm	10	<b>011 035 10</b>	12	40 07157 30023 2

## 012 A5,5



PH					Item No		EAN-Code
1	50 mm	A 5,5	5,5 mm	10	<b>012 015 10</b>	8	40 07157 30025 6
2	50 mm	A 5,5	5,5 mm	10	<b>012 025 10</b>	10	40 07157 30027 0
3	50 mm	A 5,5	5,5 mm	10	<b>012 035 10</b>	13	40 07157 30029 4

## 014 A5,5



mm					Item No		EAN-Code
2,5	50 mm	A 5,5	5,5 mm	10	<b>014 255 10</b>	7	40 07157 30031 7
3,0	50 mm	A 5,5	5,5 mm	10	<b>014 305 10</b>	8	40 07157 30033 1
4,0	50 mm	A 5,5	5,5 mm	10	<b>014 405 10</b>	9	40 07157 30035 5
5,0	50 mm	A 5,5	5,5 mm	10	<b>014 505 10</b>	11	40 07157 30037 9
6,0	50 mm	A 5,5	5,5 mm	10	<b>014 605 10</b>	12	40 07157 30039 3







»felo este specialistul dvs. cu mare experiență în produse personalizate și care vă oferă soluții de cea mai înaltă calitate.

»felo komoly tapasztalattal rendelkezik a legmagasabb minőségű, egyedi bitek gyártása terén.







## 061 6,3mm



PZ				Item No		EAN-Code
1/2	60 mm	1/4"	10	<b>061 126 10</b>	13	40 07157 30429 2
2/2	60 mm	1/4"	10	<b>061 226 10</b>	13	40 07157 50522 4
2/3	60 mm	1/4"	10	<b>061 236 10</b>	14	40 07157 30431 5





## 062 6,3mm



PH				Item No		EAN-Code
1/2	60 mm	1/4"	10	<b>062 126 10</b>	12	40 07157 30433 9
2/2	60 mm	1/4"	10	<b>062 226 10</b>	13	40 07157 50524 8
2/3	60 mm	1/4"	10	<b>062 236 10</b>	13	40 07157 30435 3





## 063 6,3mm



PH				Item No		EAN-Code
5,5 PH 2	60 mm	1/4"	10	<b>063 255 10</b>	12	40 07157 32556 3





## 070 C 8



				Item No		EAN-Code	
<b>0,8 x 5,5</b>	32 mm	C 8	5/16"	10	<b>070 514 10</b>	8	40 07157 30988 4
<b>1,0 x 5,5</b>	32 mm	C 8	5/16"	10	<b>070 524 10</b>	8	40 07157 30989 1
<b>1,0 x 6,0</b>	32 mm	C 8	5/16"	10	<b>070 604 10</b>	9	40 07157 30990 7
<b>1,2 x 6,5</b>	32 mm	C 8	5/16"	10	<b>070 614 10</b>	9	40 07157 30991 4
<b>1,2 x 8,0</b>	32 mm	C 8	5/16"	10	<b>070 804 10</b>	11	40 07157 30992 1
<b>1,6 x 8,0</b>	32 mm	C 8	5/16"	10	<b>070 814 10</b>	11	40 07157 30993 8
<b>1,6 x 10,0</b>	38 mm	C 8	5/16"	10	<b>070 104 10</b>	17	40 07157 30986 0
<b>2,0 x 12,0</b>	38 mm	C 8	5/16"	10	<b>070 204 10</b>	21	40 07157 30987 7

## 071 C 8



PZ				Item No		EAN-Code	
<b>1</b>	32 mm	C 8	5/16"	10	<b>071 010 10</b>	9	40 07157 30994 5
<b>2</b>	32 mm	C 8	5/16"	10	<b>071 020 10</b>	10	40 07157 30995 2
<b>3</b>	32 mm	C 8	5/16"	10	<b>071 030 10</b>	11	40 07157 30996 9
<b>4</b>	38 mm	C 8	5/16"	10	<b>071 042 10</b>	17	40 07157 30997 6

## 072 C 8



PH	→		↕	📦	Item No	📦	EAN-Code
<b>1</b>	32 mm	C 8	5/16"	10	<b>072 010 10</b>	9	40 07157 30998 3
<b>2</b>	32 mm	C 8	5/16"	10	<b>072 020 10</b>	10	40 07157 30999 0
<b>3</b>	32 mm	C 8	5/16"	10	<b>072 030 10</b>	10	40 07157 31000 2
<b>4</b>	38 mm	C 8	5/16"	10	<b>072 042 10</b>	16	40 07157 31001 9

## 074 C 8



mm	→		↕	📦	Item No	📦	EAN-Code
<b>3</b>	32 mm	C 8	5/16"	10	<b>074 300 10</b>	10	40 07157 31003 3
<b>4</b>	32 mm	C 8	5/16"	10	<b>074 400 10</b>	10	40 07157 31004 0
<b>5</b>	32 mm	C 8	5/16"	10	<b>074 500 10</b>	11	40 07157 31005 7
<b>6</b>	32 mm	C 8	5/16"	10	<b>074 600 10</b>	12	40 07157 31006 4
<b>8</b>	32 mm	C 8	5/16"	10	<b>074 800 10</b>	13	40 07157 31007 1
<b>10</b>	32 mm	C 8	5/16"	10	<b>074 100 10</b>	20	40 07157 31002 6

## 076 C 8



Torx®	→		↕	📦	Item No	📦	EAN-Code
<b>25</b>	32 mm	C 8	5/16"	10	<b>076 253 10</b>	10	40 07157 31008 8
<b>27</b>	32 mm	C 8	5/16"	10	<b>076 273 10</b>	10	40 07157 31009 5
<b>30</b>	32 mm	C 8	5/16"	10	<b>076 303 10</b>	11	40 07157 31010 1
<b>40</b>	32 mm	C 8	5/16"	10	<b>076 403 10</b>	11	40 07157 31011 8
<b>45</b>	32 mm	C 8	5/16"	10	<b>076 453 10</b>	12	40 07157 31012 5
<b>50</b>	32 mm	C 8	5/16"	10	<b>076 503 10</b>	13	40 07157 31013 2
<b>55</b>	32 mm	C 8	5/16"	10	<b>076 553 10</b>	18	40 07157 31014 9

## 078 C 8



XZN	→		↕	📦	Item No	📦	EAN-Code
<b>M 5</b>	35 mm	C 8	5/16"	10	<b>078 050 10</b>	11	40 07157 50384 8
<b>M 6</b>	35 mm	C 8	5/16"	10	<b>078 060 10</b>	12	40 07157 50386 2
<b>M 8</b>	35 mm	C 8	5/16"	10	<b>078 080 10</b>	13	40 07157 50388 6
<b>M10</b>	35 mm	C 8	5/16"	10	<b>078 100 10</b>	17	40 07157 50390 9
<b>M12</b>	35 mm	C 8	5/16"	10	<b>078 120 10</b>	22	40 07157 50392 3

## 078 C 8



XZN	→		↕	📦	Item No	📦	EAN-Code
<b>M 5</b>	120 mm	C 8	5/16"	10	<b>078 005 10</b>	27	40 07157 50394 7
<b>M 6</b>	120 mm	C 8	5/16"	10	<b>078 006 10</b>	48	40 07157 50396 1
<b>M 8</b>	120 mm	C 8	5/16"	10	<b>078 008 10</b>	45	40 07157 50398 5
<b>M 10</b>	120 mm	C 8	5/16"	10	<b>078 010 10</b>	71	40 07157 50400 5
<b>M 12</b>	120 mm	C 8	5/16"	10	<b>078 012 10</b>	95	40 07157 50402 9

## 081

Gewinde/  
Thread



PZ					Item No		EAN-Code
2	44,5 mm	M 5	6 mm	10	<b>081 020 10</b>	9	40 07157 31354 6
2	44,5 mm	10/32" NFA	6 mm	10	<b>081 025 10</b>	8	40 07157 31355 3

## 082

Gewinde/  
Thread



PH					Item No		EAN-Code
2	33 mm	M 5	6 mm	10	<b>082 020 20</b>	6	40 07157 53645 7
2	44,5 mm	M 5	6 mm	10	<b>082 020 10</b>	8	40 07157 31356 0
2	44,5 mm	M 6	8 mm	10	<b>082 225 10</b>	8	40 07157 62407 9
2	44,5 mm	10/32" NFA	6 mm	10	<b>082 025 10</b>	8	40 07157 31357 7

## 086

Gewinde/  
Thread



Torx®					Item No		EAN-Code
20	44,5 mm	M 5	6 mm	10	<b>086 200 10</b>	9	40 07157 31358 4
25	44,5 mm	M 5	6 mm	10	<b>086 250 10</b>	10	40 07157 31359 1
20	44,5 mm	M 6	8 mm	10	<b>086 020 10</b>	9	40 07157 63843 4
25	44,5 mm	M 6	8 mm	10	<b>086 025 10</b>	10	40 07157 63845 8

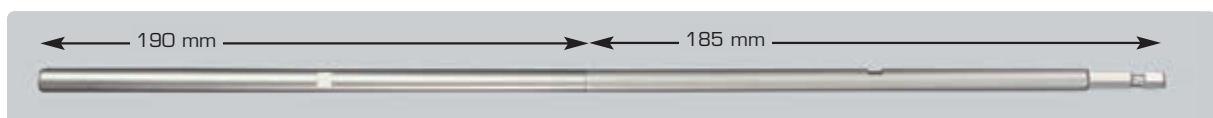

## 038

Gewinde/  
Thread

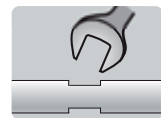

			Item No		EAN-Code
<b>Adaptor for threaded bits M6, E 6,3 / Adapter für Innengewinde Bit M6, E 6,3</b>					
185 mm	M 6	8,5 mm	1	<b>038 200 10</b>	88 40 07157 63847 2

## 038

Gewinde/  
Thread



			Item No		EAN-Code
<b>Extension for adaptor M6 interior thread M6 / exterior thread M6 / Verlängerung für Adapter M6 Innengewinde M6 / Aussengewinde M6</b>					
200 mm	M 6	8,5 mm	1	<b>038 200 20</b>	81 40 07157 63849 6

## Adaptori

### Bitbefogók és átalakítók

**038**  
**E 6,3**



**felo**  
Innovations



**Bitholder IMPACT 1/4" / Bithalter IMPACT 1/4"**



95 mm



E 6,3



6

Item No

**038 295 90**



43

EAN-Code

40 07157 63337 8

**429**



**felo**  
Innovations



**1/4"**



170

106

36



6

Item No

**429 635 40**



146

EAN-Code

40 07157 60365 4



**438**



**felo**  
Innovations



**1/4"**



100

101

33



6

Item No

**438 125 40**



102

EAN-Code

40 07157 53711 9

**338**



**1/4"**



125

100



6

Item No

**338 125 80**



111

EAN-Code

40 07157 32350 7

518



AC 1000V  
IEC 60900 : 2012



Item No



EAN-Code

1/4"

105 99 34

6

518 125 90

107

40 07157 50785 3

538



felo  
Innovations



Item No



EAN-Code

Star-

100 99 34

6

538 100 40

102

40 07157 51397 7

Automatikhalter 1/4"

038



felo  
Innovations

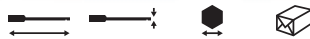

Item No



EAN-Code

FeloStar

70 mm E 6,3 1/4" 6

038 165 90

31

40 07157 50799 0

dto on card / auf Karte

70 mm E 6,3 1/4" 6

038 165 94

37

40 07157 52673 1

FeloStar

150 mm E 6,3 1/4" 6

038 169 90

55

40 07157 51979 5

FeloStar

450 mm E 6,3 1/4" 1

038 170 90

128

40 07157 60367 8

538



Item No



EAN-Code

1/4"

100 99 34

6

538 125 40

102

40 07157 32348 4

038



Item No



EAN-Code

Bitholder extra strong / Magnethalter extra stark

50 mm E 6,3 1/4" 6

038 109 90

17

40 07157 30850 4

Bitholder / Magnethalter

58 mm E 6,3 1/4" 6

038 103 90

22

40 07157 30340 0

dto. on card / auf Karte

10

038 103 96

30

40 07157 10288 1

Bitholder with retaining ring / Magnethalter mit Sprengring

74 mm E 6,3 1/4" 6

038 102 90

30

40 07157 30337 0

Bitholder with retaining ring / Magnethalter mit Sprengring

100 mm E 6,3 1/4" 6

038 105 90

31

40 07157 50458 6

Bitholder with retaining ring / Magnethalter mit Sprengring

150 mm E 6,3 1/4" 6

038 107 90

44

40 07157 50464 7

Bitholder with retaining ring / Magnethalter mit Sprengring

200 mm E 6,3 1/4" 1

038 108 90

60

40 0715 763945 5

## 018

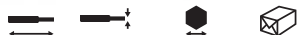

**Bitholder / Magnethalter**

60 mm A 5,5 1/4" 6

**Item No**



**EAN-Code**

**018 102 90**

30

40 07157 30043 0



## 037



**Mech. Bithalter**

51 mm E 6,3 1/4" 6

**Item No**



**EAN-Code**

**037 103 90**

25

40 07157 32146 6



## 048

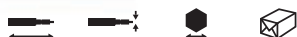

**Bitholder with retaining ring / Magnethalter mit Sprengring**

60 mm G 7 1/4" 6

**Item No**



**EAN-Code**

**048 102 80**

31

40 07157 32452 8



## 058



**Bitholder / Magnethalter**

98 mm SDS 1/4" 6

**Item No**



**EAN-Code**

**058 102 90**

58

40 07157 30978 5



## 059

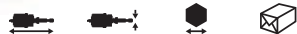

**depth stop Bit Holder / Tiefenanschlag-Bithalter**

max. 79 mm E 6,3 1/4" 6

**Item No**



**EAN-Code**

**059 103 90**

74

40 07157 51897 2



incl. Bit PH 2 x 25

# 097



1/4" ■

					Item No		EAN-Code
	<b>Extension / Verlängerung</b>						
	75 mm	E 6,3	1/4"	6	<b>097 070 10</b>	45	40 07157 52423 2

# 097



1/4" ■

					Item No		EAN-Code	
	<b>Adapter</b>	25 mm	1/4"	C 6,3	6	<b>097 018 10</b>	14	40 07157 30851 1

# 397

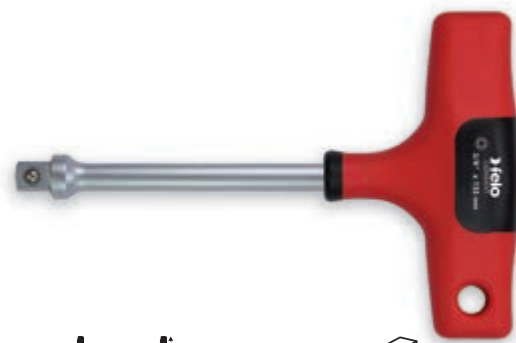

□

					Item No		EAN-Code
	<b>T-Handle with square adapter / T-Griff mit 4-Kant Adapter</b>						
1/2"	125	100		6	<b>397 127 80</b>	150	40 07157 62897 8
1/4"	125	100		6	<b>397 635 80</b>	103	40 07157 62899 2
3/8"	125	100		6	<b>397 952 80</b>	135	40 07157 62901 2

# 097

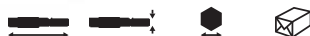

1/4" ■

					Item No		EAN-Code	
	<b>Adapter</b>	50 mm	A 5,5	1/4"	6	<b>097 011 10</b>	15	40 07157 30479 7

# 097



1/4" ■

					Item No		EAN-Code	
	<b>Adapter</b>	50 mm	E 6,3	1/4"	6	<b>097 013 10</b>	15	40 07157 30481 0
		150 mm	E 6,3	1/4"	1	<b>097 150 14</b>	62	40 07157 32128 2

# 097



3/8" ■

					Item No		EAN-Code	
	<b>Adapter</b>	50 mm	E 6,3	3/8"	6	<b>097 020 10</b>	23	40 07157 30489 6



### Fălci striate fin ce generează un grip perfect

*finoman fogazott pofák, amelyek határozott szorítást biztosítanak*

### Partea de tăiere întărită prin inducție (60/64 HRC)

*indukciósan edzett élek (60/64 HRC)*

### Îmbinare precisă pentru obținerea pârgheii perfecte

*pontos illesztés az optimális erőátvitelhez*

**Rezistență anti-coroziune optima de lungă durată datorată suprafeței cromată mat.**

*a speciális matt króm felület hosszú élettartamú korrózióvédelmet biztosít*

**Performanțe de tăiere deosebite și înaltă precizie**

*kiváló vágási teljesítmény a legnagyobb pontosság mellett*

**Calitate profesională pentru utilizare Heavy Duty.**

## Clești / Fogók

*Profeszionális minőség a nagy igénybevételhez*

### Aripioare anti-alunecare pentru mânuire în siguranță

*Csúszásmentes markolat*

### Design ergonomic rafinat pentru confort maxim

*ergonómiailag kifinomult kialakítás a tökéletes kényelemért*

**Modelele cu mâner roșu/galben sunt testate individual la 10.000 de Volți și certificate pentru 1000 de Volți în conformitate cu standardul VDE IEC 60900:2004**

*piros / sárga modellek 10.000 Volttal egyedileg tesztelve - 1000 Voltos tanúsítvánnyal VDE IEC 60900*

**Duritate superioară ce depășește standardele DIN ISO cu până la 100%**

*kiváló keménység, amely 100%-kal meghaladja a DIN ISO követelményeket*

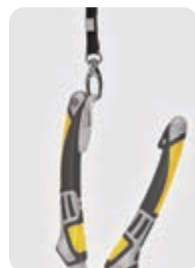

### Prindere SystemClip cu lanyard de siguranță

*Socket SystemClip biztonsági pánttal (nem tartozék, külön rendelhető)*

### Forjat din oțel special

*speciális acélból kovácsolva*

### Tehnologie mâner bi-component

*kétkomponenses markolat*



### Testate GS pentru siguranță

*GS minőségi tanúsítvány*



### Cod EAN pe fiecare produs

*EAN vonalkód minden terméken*

### Calitatea manoperei și a materialelor garantată

*garantáltan kiváló minőségű anyagokból*





**Clești pentru electricieni cu trăsături multifuncționale pentru muncă precisă și eficientă la cele mai înalte standard de siguranță**

*A többfunkciós villanszerelő fogók használatával pontos és hatékony munka a legmagasabb biztonsági előírások mellett.*

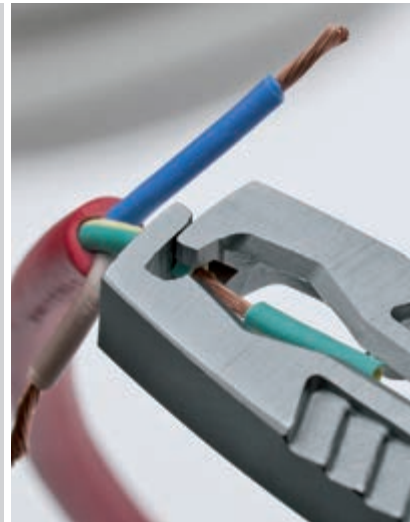

**Cleștii »felo :Inovație, design rafinat și i durabilitate excepțională**

**»felo fogók: Innováció, kifinomult kialakítás és kivételes tartósság**



**Cei mai buni clești produși de către ingineria germană.**

**Îndeplinesc cele mai stricte cerințe de calitate**

*A legjobb fogók a német mérnökök és szakmunkások összefogásából. A legszigorúbb minőségi elvárásoknak is megfelel.*



**Gripping & cutting: tough work is the ultimate test for perfect tools.**

*Szorítás és vágás: hibátlan munkát és tökéletes eredményt, csakis tökéletes eszközökkel lehet elérni.*





590



Item No



EAN-Code

165 mm Combination Pliers / Kombizange

6

590 016 40

170

40 07157 63771 0

180 mm Combination Pliers / Kombizange

6

590 018 40

240

40 07157 63773 4



591



Item No



EAN-Code

145 mm Diagonal Nippers / Seitenschneider

6

591 014 40

160

40 07157 63775 8

160 mm Diagonal Nippers / Seitenschneider

6

591 016 40

200

40 07157 63777 2

180 mm Diagonal Nippers / Seitenschneider

6

591 018 40

240

40 07157 63779 6



591



Item No



EAN-Code

180 mm Heavy-duty Diagonal Nippers

6

591 118 40

245

40 07157 63781 9

180 mm Kraftseitenschneider



592



Item No



EAN-Code

205 mm Chain Nose Radio Pliers

6

592 020 40

190

40 07157 63783 3

205 mm Telefonzange (Flachrundzange)



592



Item No



EAN-Code

205 mm Chain Nose Radio Plier curved 45°

6

592 220 40

190

40 07157 63785 7

205 mm Telefonzange 45° gebogen

**591**



**Item No**



**EAN-Code**

**200 mm Heavy Duty Lever Side Cutter**

6

**591 020 40**

330

40 07157 63789 5

*200 mm Hebel-Kraftseitenschneider*

**894**



**DIN ISO 9243**



**Item No**



**EAN-Code**

**210 mm Pincers / 210 mm Kneifzange**

6

**894 020 40**

365

40 07157 63813 7

**895**



**Item No**



**EAN-Code**

**250 mm Waterpump Pliers MX**

6

**895 250 40**

340

40 07157 63815 1

*250 mm Wasserpumpenzange MX*

**300 mm Waterpump Pliers MX**

6

**895 300 40**

480

40 07157 63819 9

*300 mm Wasserpumpenzange MX*

**895**



**Item No**



**EAN-Code**

**240 mm Waterpump Pliers Classic**

6

**895 025 40**

350

40 07157 63787 1

*240 mm Wasserpumpenzange Classic*

## Clești VDE / Szigetelt fogók

Scule pentru siguranță, produse în Germania

Biztonságos szerszámok Németországból



AC 1000V  
IEC 60900 : 2012

580



Item No

AC 1000V  
IEC 60900 : 2012



EAN-Code

165 mm Combination Pliers VDE/ Kombizange VDE 6

580 016 40

180

40 07157 63791 8

180 mm Combination Pliers VDE/ Kombizange VDE 6

580 018 40

250

40 07157 63793 2

581



Item No

AC 1000V  
IEC 60900 : 2012



EAN-Code

160 mm Diagonal Nippers VDE/ Seitenschneider 6

581 016 40

210

40 07157 63795 6

180 mm Diagonal Nippers VDE/ Seitenschneider 6

581 018 40

240

40 07157 63797 0

582



Item No

AC 1000V  
IEC 60900 : 2012

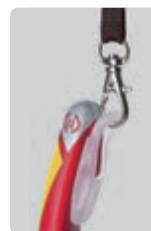

EAN-Code

170 mm Chain Nose Radio Pliers VDE

6

582 017 40

150

40 07157 63799 4

170 mm Telefonzange VDE (Flachrundzange)

582



Item No

AC 1000V  
IEC 60900 : 2012



EAN-Code

205 mm Chain Nose Radio Pliers VDE

6

582 225 40

200

40 07157 63801 4

curved 45°

205 mm Telefonzange VDE 45° gebogen

583



AC 1000V  
IEC 60900 : 2012



Item No



EAN-Code

160 mm Insulation Stripping Pliers

6

583 016 40

180

40 07157 63803 8

160 mm Abisolierzange

584



AC 1000V  
IEC 60900 : 2012

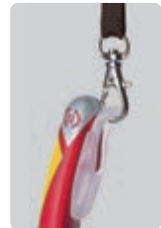

Item No



EAN-Code

160 mm Cable Cutter VDE

6

584 016 40

305

40 07157 63805 2

160 mm Kabelschneider VDE

581



AC 1000V  
IEC 60900 : 2012



Item No



EAN-Code

200 mm Heavy Duty Diagonal Nippers VDE

6

581 020 40

305

40 07157 63807 6

200 mm Kraftseitenschneider VDE

586



AC 1000V  
IEC 60900 : 2012



Item No



EAN-Code

180 mm Multi Cutter VDE

6

586 018 40

305

40 07157 63811 3

180 mm Multifunktionale Abisolierzange VDE

580



Item No



EAN-Code

Safety lanyard with SystemClip

5

580 001 00

10

40 07157 63851 9

Sicherungsband mit SystemClip

## Seturile VDE: echipamentul perfect pentru profesioniști Szigetelt szerszámkészletek profiknak

413



AC 1000V  
IEC 60900 : 2012 



	Item No		EAN-Code
<b>VDE Service Kit ERGONIC 11-pcs / Werkzeugtasche VDE11-tlg.</b>	<b>413 911 04</b>	1580	40 07157 63855 7
(3 x) <b>413:</b>	3,5 x 0,6 / 4,0 x 100 / 5,5 x 1,0		
(3 x) <b>414:</b>	PH 0 x 60 / PH 1 x 80 / PH 2 x 100		
(1 x)	<b>Mains testing Screwdriver / Spannungsprüfer</b> 3,0 mm x 70 mm (VDE 0680/6, 150-250 Volt)		
(1 x)	<b>Combination Pliers / Kombizange</b> 180 mm		
(1 x)	<b>Diagonal Nippers / Seitenschneider</b> 160 mm		
(1 x)	<b>Chain Nose Radio Pliers VDE / Telefonzange VDE (Flachrundzange)</b> 170 mm		
(1 x)	<b>Cable Stripper / Kabelmesser</b>		
	<b>Nylon bag / Nylon Tasche</b> 330 x 270 x 55 mm		

413



AC 1000V  
IEC 60900 : 2012 



	Item No		EAN-Code
<b>VDE Service Kit E-slim 11-pcs / Werkzeugtasche VDE E-Slim 11-tlg.</b>	<b>413 811 04</b>	1615	40 07157 63857 1
(3 x) <b>413:</b>	3,5 x 0,6 / 4,0 x 100 / 5,5 x 1,0		
(2 x) <b>414:</b>	PH 1 x 80 / PH 2 x 100		
(1 x) <b>415:</b>	PZ 2 x 100		
(1 x)	<b>Mains testing Screwdriver / Spannungsprüfer</b> 3,0 mm x 70 mm (VDE 0680/6, 150-250 Volt)		
(1 x)	<b>Combination Pliers / Kombizange</b> 180 mm		
(1 x)	<b>Diagonal Nippers / Seitenschneider</b> 160 mm		
(1 x)	<b>Chain Nose Radio Pliers VDE / Telefonzange VDE (Flachrundzange)</b> 170 mm		
(1 x)	<b>Cable Stripper / Kabelmesser</b>		
	<b>Nylon bag / Nylon Tasche</b> 330 x 270 x 55 mm		



AC 1000V

IEC 60900 : 2012



**felo**  
Innovations

413



	Item No		EAN-Code
<b>VDE Belt Pouch 9-pcs / VDE Gürteltasche 9-tlg.</b>	<b>413 995 04</b>	1040	40 07157 63859 5
(3 x) <b>413:</b>	3,5 x 0,6 / 4,0 x 0,8 / 5,5 x 1,0		
(2 x) <b>414:</b>	PH 1 x 80 / PH 2 x 100		
(1 x)	<b>Mains testing Screwdriver / Spannungsprüfer</b> 3,0 mm x 70 mm (VDE 0680/6, 150-250 Volt)		
(1 x)	<b>Combination Pliers / Kombizange</b> 180 mm		
(1 x)	<b>Diagonal Nippers / Seitenschneider</b> 160 mm		
(1 x)	<b>Cable Stripper / Kabelmesser</b>		
	<b>Nylon bag / Nylon Tasche</b> 290x 250 x 20 mm		



AC 1000V

IEC 60900 : 2012



**felo**  
Innovations

413



	Item No		EAN-Code
<b>XL Tool set VDE with pliers and screwdrivers 8-pcs /</b> <i>XL Werkzeugsatz VDE mit Zangen und Schraubendrehern 8-tlg.</i>	<b>413 985 17</b>	1070	40 07157 63853 3
(3 x) <b>413:</b>	3,5 x 0,6 / 4,0 x 0,8 / 5,5 x 1,0		
(2 x) <b>414:</b>	PH 0 x 60 / PH 1 x 80 / PH 2 x 100		
(1 x) <b>580:</b>	<b>Combination Pliers / Kombizange</b> 180 mm		
(1 x) <b>581:</b>	<b>Diagonal Nippers / Seitenschneider</b> 160 mm		

**Display-urile permanente Felo pentru seriile individuale de produs și grupe de produs, best seller-e și sortimente complete, demonstrează cu succes competența dvs. în sculele de mâna.**

*A FELO értékesítést elősegítő állványai minden szerszámcsaládhoz és termékhez. Könnyebb értékesítés az áttekinthető választék bemutatásával.*

## Variante de prezentare & Merchandising

### Bemutató állványok

### Display-uri / Bemutató állvány

**Display-urile noastre de teighea pot fi amplasate oriunde și sunt ideale pentru promoțiile point-of-sale.**

*Az ideiglenes bemutató állványok segítségével az akciós termékek bármely frekvencián helyen elhelyezhetők.*







400







	Item No		EAN-Code
<b>Rolldisplay 128-tlg.</b> (1540 x 500 x 450 mm)	<b>391 091 00</b>	31000	40 07157 63471 9
<b>400:</b>	3,0 x 80 (5 Stk./pcs.) / 4,0 x 100 (5 Stk./pcs.) 5,5 x 125 (5 Stk./pcs.) / 6,5 x 150 (5 Stk./pcs.) / 8,0 x 175 (5 Stk./pcs.)		
<b>401:</b>	PZ 1 x 80 (5 Stk./pcs.) / PZ 2 x 100 (5 Stk./pcs.)		
<b>402:</b>	PH 1 x 80 (5 Stk./pcs.) / PH 2 x 100 (5 Stk./pcs.)		
<b>508:</b>	Torx® 10 x 100 (5 Stk./pcs.) / Torx® 15 x 100 (5 Stk./pcs.) Torx® 20 x 100 (5 Stk./pcs.) / Torx® 25 x 100 (5 Stk./pcs.)		
<b>400 951 18 Ergonic Set</b> (4 Stk./pcs.)			
<b>413:</b>	2,5 x 75 (5 Stk./pcs.) / 3,5 x 100 (5 Stk./pcs.) <b>AC 1000V IEC 60900 : 2012</b> 4,0 x 100 (5 Stk./pcs.) / 5,5 x 125 (5 Stk./pcs.) <b>AC 1000V IEC 60900 : 2012</b>		
<b>414:</b>	PH 1 x 80 (5 Stk./pcs.) / PH 2 x 100 (5 Stk./pcs.) <b>AC 1000V IEC 60900 : 2012</b>		
<b>413 961 98 Ergonic Set VDE</b> (4 Stk./pcs.) <b>AC 1000V IEC 60900 : 2012</b>			
<b>063 913 01 E-smart</b> (3 Stk./pcs.) <b>AC 1000V IEC 60900 : 2012</b>			
<b>361 400 01 Mains testing screwdriver / Profi-Spannungsprüfer</b> VDE 0680 150 V – 250 V (6 Stk./pcs.)			
<b>376 041 05 Magazine Handle Bitholder (long) on card / Magazingriff Bithalter (lang) auf Karte</b> (4 Stk./pcs.)			
<b>020 603 71 swift Box TiN</b> (4 Stk./pcs.)			
<b>020 601 11 swift Box Universal</b> (4 Stk./pcs.)			
<b>020 603 11 swift Box Torx®</b> (4 Stk./pcs.)			



400







	Item No		EAN-Code
<b>Display for 5 ERGONIC Sets / Display für 5 ERGONIC Sätze</b> [230 x 120 x 440 mm]	<b>400 905 10</b>	1970	40 07157 61303 5
(5 x ) <b>400 931 18</b>			
<b>Display for 5 ERGONIC Sets VDE / Display für 5 ERGONIC Sätze VDE</b> (5 x ) <b>413 931 94</b>    <b>AC 1000V</b> <b>IEC 60900 : 2012</b>	<b>413 905 90</b>	1680	40 07157 61341 7

**Customized selections upon request / Individuelle Zusammenstellungen auf Anfrage**



400



	Item No		EAN-Code
<b>Display for 7 ERGONIC Sets / Display für 7 ERGONIC Sätze</b> [280 x 265 x 450 mm]	<b>400 907 10</b>	3800	40 07157 61377 6
(7 x ) <b>400 951 18</b>			
<b>Display for 7 ERGONIC Sets VDE / Display für 7 ERGONIC Sätze VDE</b> (7 x ) <b>413 961 98</b>    <b>AC 1000V</b> <b>IEC 60900 : 2012</b>	<b>413 907 90</b>	3895	40 07157 61375 2

**Customized selections upon request / Individuelle Zusammenstellungen auf Anfrage**



**370**



	Item No		EAN-Code
<b>Display for 12 Magazine Handles / Display für 12 Magazingriffe</b>	<b>376 912 00</b>	2970	40 07157 61333 2
[280 x 265 x 450 mm]			
(6 x )	<b>374 004 05</b>		
(6 x )	<b>376 041 05</b>		

**Customized selections upon request / Individuelle Zusammenstellungen auf Anfrage**



**400**



	Item No		EAN-Code
<b>Display for 8 Bit Boxes / Display für 8 Bit Boxen</b>	<b>020 138 70</b>	926	40 07157 61379 0
(8 x )	<b>020 917 16)</b>		

**Customized selections upon request / Individuelle Zusammenstellungen auf Anfrage**

## Display **RGONIC**<sup>®</sup>



### 400





		Item No		EAN-Code
<b>Display 58-tlg.</b>	(460 x 350 x 210 mm)	<b>400 991 10</b>	6005	40 07157 53703 4
<b>400:</b>	2,5 x 75 (6 Stk./pcs.) / 3,5 x 100 (6 Stk./pcs.)			
	4,0 x 100 (6 Stk./pcs.) / 5,5 x 125 (5 Stk./pcs.)			
	6,5 x 150 (5 Stk./pcs.) / 8,0 x 175 (4 Stk./pcs.)			
<b>401:</b>	PZ 1 x 80 (6 Stk./pcs.) / PZ 2 x 100 (5 Stk./pcs.)			
<b>402:</b>	PH 1 x 80 (6 Stk./pcs.) / PH 2 x 100 (5 Stk./pcs.)			
	PH 3 x 150 (4 Stk./pcs.)			
<b>Standard Display 11 Pegs, empty / 11 Haken, leer</b>		<b>391 011 00</b>	<b>20,40 (net / netto)</b>	



### 410



		Item No		EAN-Code
<b>Display 63-tlg.</b>	(460 x 350 x 210 mm)	<b>410 991 40</b>	6277	40 07157 53311 1
<b>410:</b>	4,0 x 75 (6 Stk./pcs.) / 5,5 x 100 (5 Stk./pcs.)			
	6,5 x 125 (5 Stk./pcs.)			
<b>411:</b>	PZ 1 x 80 (6 Stk./pcs.) / PZ 2 x 100 (5 Stk./pcs.)			
<b>412:</b>	PH 1 x 80 (6 Stk./pcs.) / PH 2 x 100 (5 Stk./pcs.)			
<b>413:</b>	3,5 x 100 (8 Stk./pcs.) / 4,0 x 100 (6 Stk./pcs.)			
<b>414:</b>	PH 1 x 80 (6 Stk./pcs.) / PH 2 x 100 (5 Stk./pcs.)			
				AC 1000V IEC 60900 : 2012
				AC 1000V IEC 60900 : 2012
<b>Standard Display 11 Pegs, empty / 11 Haken, leer</b>		<b>391 011 00</b>		



AC 1000V  
IEC 60900 : 2012



400



		Item No		EAN-Code
<b>Display 61-tlg.</b>	(460 x 350 x 210 mm)	<b>413 991 90</b>	5336	40 07157 53705 8
<b>413:</b>	2,5 x 75 (6 Stk./pcs.) / 3,0 x 100 (6 Stk./pcs.)			
	3,5 x 100 (6 Stk./pcs.) / 4,0 x 100 (6 Stk./pcs.)			
	4,5 x 125 (5 Stk./pcs.) / 5,5 x 125 (5 Stk./pcs.)			
	6,5 x 150 (5 Stk./pcs.)			
<b>415:</b>	PZ 2 x 100 (5 Stk./pcs.)			
<b>414:</b>	PH 0 x 60 (6 Stk./pcs.) / PH 1 x 80 (6 Stk./pcs.) / PH 2 x 100 (5 Stk./pcs.)			

Standard Display 11 Pegs, empty / 11 Haken, leer

**391 011 00**



Sets not included.  
*Ohne Sätze*

AC 1000V  
IEC 60900 : 2012



413



		Item No		EAN-Code
<b>E-slim Kombi Display 22 pcs. VDE</b>		<b>413 881 90</b>	2471	40 07157 62749 0
(4 x 3) <b>413:</b>	3,0 x 100 / 3,5 x 100 / 4,0 x 100 / 5,5 x 125			
(2 x ) <b>413:</b>	6,5 x 125			
(2 x ) <b>414:</b>	PH 1 x 80			
(3 x ) <b>414:</b>	PH 2 x 100			
(3 x ) <b>415:</b>	PZ 2 x 100			

## Display Serie 550



### 550



		Item No		EAN-Code
<b>Display 41-tlg.</b>	(460 mm x 390 mm xy 230 mm)	<b>550 993 40</b>	7908	40 07157 53523 8
<b>550:</b>	4,5 x 100 (4 Stk./pcs.) / 5,5 x 100 (4 Stk./pcs.)			
	6,5 x 125 (4 Stk./pcs.) / 8,0 x 155 (4 Stk./pcs.)			
	10,0 x 175 (3 Stk./pcs.) / 12,0 x 200 (3 Stk./pcs.)			
<b>551:</b>	PZ 1 (4 Stk./pcs.) / PZ 2 (4 Stk./pcs.)			
<b>552:</b>	PH 1 (4 Stk./pcs.) / PH 2 (4 Stk./pcs.)			
	PH 3 (3 Stk./pcs.)			
<b>Standard Display, empty / Standart Display, leer</b>		<b>391 014 00</b>		

## Display Serie 500



### 500



		Item No		EAN-Code
<b>Display 72-tlg.</b>	(460 x 350 x 210 mm)	<b>500 992 10</b>	6165	40 07157 50829 4
<b>500:</b>	5,5 x 25 (6 Stk./pcs.) / 3,5 x 100 (8 Stk./pcs.)			
	4,0 x 100 (7 Stk./pcs.) / 5,5 x 125 (6 Stk./pcs.)			
	6,5 x 150 (6 Stk./pcs.) / 8,0 x 175 (5 Stk./pcs.)			
<b>501:</b>	PZ 1 x 80 (7 Stk./pcs.) / PZ 2 x 100 (6 Stk./pcs.)			
<b>502:</b>	PH 0 x 60 (8 Stk./pcs.) / PH 1 x 80 (7 Stk./pcs.)			
	PH 2 x 100 (6 Stk./pcs.)			
<b>Standard Display 11 Pegs, empty / 11 Haken, leer</b>		<b>391 011 00</b>		

500



	Item No		EAN-Code
<b>Display 74-tlg.</b> (460 x 350 x 210 mm)	<b>500 994 10</b>	6013	40 07157 51709 8
<b>500:</b> 4,0 x 100 (7 Stk./pcs.) / 5,5 x 125 (6 Stk./pcs.) 6,5 x 150 (6 Stk./pcs.)			
<b>501:</b> PZ 1 x 80 (7 Stk./pcs.) / PZ 2 x 100 (6 Stk./pcs.)			
<b>502:</b> PH 1 x 80 (7 Stk./pcs.) / PH 2 x 100 (6 Stk./pcs.)			
<b>513:</b> 3,5 x 100 (8 Stk./pcs.) / 4,0 x 100 (8 Stk./pcs.)			AC 1000V IEC 60900 : 2012
<b>514:</b> PH 1 x 80 (7 Stk./pcs.) / PH 2 x 100 (6 Stk./pcs.)			AC 1000V IEC 60900 : 2012

Standard Display 11 Pegs, empty / 11 Haken, leer

391 011 00

500



	Item No		EAN-Code
<b>Display 76-tlg.</b> (460 x 350 x 210 mm)	<b>508 912 40</b>	5653	40 07157 51711 1
<b>508:</b> Torx® 6 x 60 (10 Stk./pcs.) / Torx® 7 x 60 (8 Stk./pcs.) Torx® 8 x 60 (8 Stk./pcs.) / Torx® 9 x 60 (8 Stk./pcs.) Torx® 10 x 100 (7 Stk./pcs.) / Torx® 15 x 100 (7 Stk./pcs.) Torx® 20 x 100 (6 Stk./pc.s) / Torx® 25 x 100 (6 Stk./pcs.) Torx® 27 x 100 (6 Stk./pcs.) / Torx® 30 x 115 (5 Stk./pcs.) Torx® 40 x 125 (5 Stk./pcs.)			

Standard Display 11 Pegs, empty / 11 Haken, leer

391 011 00

500



	Item No		EAN-Code
<b>Display 82-tlg.</b> (460 x 350 x 210 mm)	<b>513 991 90</b>	5667	40 07157 51863 7
<b>513:</b> 2,5 x 75 (10 Stk./pcs.) / 3,0 x 100 (10 Stk./pcs.) 3,5 x 100 (8 Stk./pcs.) / 4,0 x 100 (8 Stk./pcs.) 5,5 x 125 (6 Stk./pcs.) / 6,5 x 150 (6 Stk./pcs.)			AC 1000V IEC 60900 : 2012
<b>514:</b> PH 0 x 60 (8 Stk./pcs.) / PH 1 x 80 (7 Stk./pcs.,) PH 2 x 100 (6 Stk./pcs.)			
<b>515:</b> PZ 1 x 80 (7 Stk./pcs.) / PZ 2 x 100 (6 Stk./pcs.)			

Standard Display 11 Pegs, empty / 11 Haken, leer

391 011 00



felo  
Innovations

## 500



		Item No		EAN-Code
<b>Display 76-tlg. M-TEC</b> (460 x 350 x 210 mm)		<b>500 991 30</b>	5967	40 07157 51717 3
<b>500:</b>	3,0 x 80 (8 Stk./pcs.) / 3,5 x 100 (8 Stk./pcs.) 4 x 100 (7 Stk./pcs.)			
<b>501:</b>	PZ 1 x 80 (7 Stk./pcs.) / PZ 2 x 100 (6 Stk./pcs.)			
<b>502:</b>	PH 1 x 80 (7 Stk./pcs.) / PH 2 x 100 (6 Stk./pcs.)			
<b>508:</b>	Torx® 10 x 100 (8 Stk./pcs.) / Torx® 15 x 100 (7 Stk./pcs.) Torx® 20 x 100 (6 Stk./pcs.) / Torx® 25 x 100 (6 Stk./pcs.)			
<b>Standard Display 11 Pegs, empty / 11 Haken, leer</b>		<b>391 011 00</b>		

## Display Serie 600



AC 1000V  
IEC 60900 : 2012

## 613



		Item No		EAN-Code
<b>IEC Display 80-tlg.</b> (460 x 350 x 210 mm)		<b>613 992 90</b>	5382	40 07157 50837 9
<b>613:</b>	2,5 x 75 (9 Stk./pcs.) / 3,0 x 100 (9 Stk./pcs.) 3,5 x 100 (8 Stk./pcs.) / 4,0 x 100 (7 Stk./pcs.) 5,5 x 125 (6 Stk./pcs.) / 6,5 x 150 (6 Stk./pcs.)			
<b>614:</b>	PH 0 x 60 (9 Stk./pcs.) / PH 1 x 80 (7 Stk./pcs.) PH 2 x 100 (6 Stk./pcs.)			
<b>615:</b>	PZ 1 x 80 (7 Stk./pcs.) / PZ 2 x 100 (6 Stk./pcs.)			
<b>Standard Display 11 Pegs, empty / 11 Haken, leer</b>		<b>391 011 00</b>		



## Display Serie 206

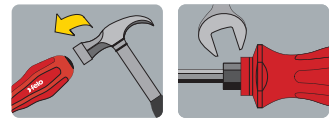

206



		Item No		EAN-Code
<b>Display 41-tlg.</b>	(460 x 350 x 210 mm)	<b>206 992 90</b>	6280	40 07157 57797 9
<b>200:</b>	4,0 x 100 (4 Stk./pcs.)			
<b>206:</b>	5,5 x 100 (4 Stk./pcs.) / 6,5 x 125 (4 Stk./pcs.)			
	8,0 x 150 (4 Stk./pcs.) / 10,0 x 175 (3 Stk./pcs.)			
	12,0 x 200 (3 Stk./pcs.)			
<b>201:</b>	PZ 1 x 80 (4 Stk./pcs.)			
<b>216:</b>	PZ 2 x 100 (4 Stk./pcs.)			
<b>202:</b>	PH 1 x 80 (4 Stk./pcs.)			
<b>226:</b>	PH 2 x 100 (4 Stk./pcs.) / PH 3 x 150 (3 Stk./pcs.)			
<b>Standard Display, empty / Standart Display, leer</b>		<b>391 014 00</b>		

## Display Serie 200



200









		Item No		EAN-Code
<b>Display 75-tlg.</b>	(460 x 350 x 210 mm)	<b>200 994 90</b>	5438	40 07157 50841 6
<b>200:</b>	3,5 x 100 (8 Stk./pcs.) / 4,0 x 100 (7 Stk./pcs.)			
	5,5 x 25 (6 Stk./pcs.) / 5,5 x 125 (6 Stk./pcs.)			
	6,5 x 150 (6 Stk./pcs.)			
<b>201:</b>	PZ 0 x 60 (8 Stk./pcs.) / PZ 1 x 80 (7 Stk./pcs.)			
	PZ 2 x 100 (6 Stk./pcs.)			
<b>202:</b>	PH 0 x 60 (8 Stk./pcs.) / PH 1 x 80 (7 Stk./pcs.)			
	PH 2 x 100 (6 Stk./pcs.)			
<b>Standard Display 11 Pegs, empty / 11 Haken, leer</b>		<b>391 011 00</b>		



200



		Item No		EAN-Code
<b>Display 73-tlg.</b>	(460 mm x 350 mm x 210 mm)	<b>200 997 90</b>	5790	40 07157 51753 1
<b>200:</b>	4,0 x 100 (7 Stk./pcs.) / 5,0 x 125 (6 Stk./pcs.)			
	6,5 x 125 (6 Stk./pcs.)			
<b>201:</b>	PZ 1 x 80 (7 Stk./pcs.) / PZ 2 x 100 (6 Stk./pcs.)			
<b>202:</b>	PH 1 x 80 (7 Stk./pcs.) / PH 2 x 100 (6 Stk./pcs.)			
<b>613:</b>	3,5 x 100 (8 Stk./pcs.) / 4,0 x 100 (7 Stk./pcs.)	  	AC 1000V IEC 60900 : 2012	
<b>614:</b>	PH 1 x 80 (7 Stk./pcs.) / PH 2 x 100 (6 Stk./pcs.)	  	AC 1000V IEC 60900 : 2012	

Standard Display 11 Pegs, empty / 11 Haken, leer

**391 011 00**



200



		Item No		EAN-Code
<b>Display 74-tlg.</b>	(460 mm x 350 mm x 210 mm)	<b>208 991 90</b>	5469	40 07157 51755 5
<b>208:</b>	Torx® 6 (8 Stk./pcs.) / Torx® 7 (8 Stk./pcs.)			
	Torx® 8 (8 Stk./pcs.) / Torx® 9 (8 Stk./pcs.)			
	Torx® 10 (7 Stk./pcs.) / Torx® 15 (7 Stk./pcs.)			
	Torx® 20 (6 Stk./pcs.) / Torx® 25 (6 Stk./pcs.)			
	Torx® 27 (6 Stk./pcs.) / Torx® 30 (5 Stk./pcs.)			
	Torx® 40 (5 Stk./pcs.)			

Standard Display 11 Pegs, empty / 11 Haken, leer

**391 011 00**

# Display Serie 240/250



240



	Item No		EAN-Code
<b>Boxen-Display 10-tlg.</b> (220 x 290 x 250 mm)	<b>240 961 50</b>	3243	40 07157 50018 2
(5 x ) <b>240:</b> <b>240 961 56</b>			
(5 x ) <b>248:</b> <b>248 961 56</b>			
<b>Display Boxen 240 empty / leer</b>	<b>391 023 00</b>		



240



	Item No		EAN-Code
<b>Display 48-tlg.</b> (250 x 290 x 150 mm)	<b>240 990 50</b>	1844	40 07157 31804 6
(4 x 6) <b>240:</b> 2,5 x 60 / 3,0 x 60			
3,5 x 100 / 4,0 x 100			
(2 x 6) <b>241:</b> PZ 0 x 60 / PZ 1 x 60			
(2 x 6) <b>242:</b> PH 0 x 60 / PH 1 x 60			
<b>Display Serie 240, 8 Pegs, empty / 8 Haken, leer</b>	<b>391 020 00</b>		



## 240



**Kombi-Display** (220 x 290 x 250 mm)

Item No



EAN-Code

**240 951 50**

2563

40 07157 51703 6

[5 x ] **240:** 240 961 56



[6 x ] **240:** 2,5 x 60 / 3,5 x 100

[6 x ] **242:** PH 0 x 60



[6 x ] **248:** Torx® 6 x 60

**Kombi-Display, empty / leer**

**391 023 50**



## 280



**Boxen-Display 10-tlg.** (260 x 300 x 220 mm)

Item No



EAN-Code

**280 961 10**

2933

40 07157 50753 2

[5 x ] **280:** **280 907 06**



[5 x ] **280:** **280 907 26**





ESD Safe  
 $10^8 - 10^{10} \Omega$



250



**Boxen-Display 10-tlg.** (260 x 300 x 220 mm)  
 (10 x) **250: 250 961 86**

Item No

**250 961 80**



3318

EAN-Code

40 07157 50296 4

## Display Serie 330

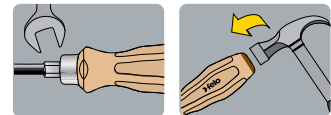

330



**Display 41-tlg.** (460 x 350 x 210 mm)  
 (4 x 4) **335:** 4,5 x 90 / 5,5 x 100 /  
 7,0 x 125 / 9,0 x 150  
 (2 x 3) 10,0 x 175 / 12,0 x 200  
 (2 x 4) **336:** PZ 1 x 80 / PZ 2 x 100  
 (1 x 3) PZ 3 x 150  
 (2 x 4) **337:** PH 1 x 80 / PH 2 x 100

Item No

**335 991 90**



7450

EAN-Code

40 071575 7799 3

**Standard Display, empty / Standart Display, leer**

**391 014 00**

## Display Bits



381



1/4"

Item No			EAN-Code
<b>391 818 90</b>	<b>Bit Display 177-pcs / 177-tlg</b> (460 x 350 x 210 mm)	4840	40 07157 63333 0
	10 x 020 520 36	2 Stk./ pcs.	5,5 x 25 mm
	10 x 020 610 36	2 Stk./ pcs.	6,5 x 25 mm
	10 x 020 800 36	2 Stk./ pcs.	8,0 x 25 mm
	10 x 021 010 36	2 Stk./ pcs.	PZ1 x 25 mm
	10 x 021 020 36	2 Stk./ pcs.	PZ2 x 25 mm
	10 x 021 030 36	2 Stk./ pcs.	PZ3 x 25 mm
	10 x 022 010 36	2 Stk./ pcs.	PH1 x 25 mm
	10 x 022 020 36	2 Stk./ pcs.	PH2 x 25 mm
	10 x 022 030 36	2 Stk./ pcs.	PH2 x 25 mm
	10 x 031 025 36	2 Stk./ pcs.	PZ2 x 50 mm
	10 x 032 025 36	2 Stk./ pcs.	PH2 x 50 mm
	10 x 026 100 36	2 Stk./ pcs.	Torx® 10 x 25 mm
	10 x 026 150 36	2 Stk./ pcs.	Torx® 15 x 25 mm
	10 x 026 200 36	2 Stk./ pcs.	Torx® 20 x 25mm
	10 x 026 250 36	2 Stk./ pcs.	Torx® 25 x 25mm
	10 x 026 300 36	2 Stk./ pcs.	Torx® 30 x 25mm
	10 x 026 400 36	2 Stk./ pcs.	Torx® 40 x 25mm
	7 x 038 103 96	1 Stk./ pcs.	<b>Bitholder / Magnethalter</b> 58mm



038



1/4"

Item No			EAN-Code
<b>038 224 90</b>	<b>Display for Impact Bitholders / Display Impact Bithalter</b>	2208	40 07157 58723 7
	24 x 038 295 94 (345 x 245 x 170 mm)		

210



## 020



1/4"

	Item No		EAN-Code
<b>Bit-Tray 300-pcs/ Zahlteiler</b> (275 x 270 x 33 mm)	<b>020 950 06</b>	2129	40 07157 51317 5
10 x PH 1 x 25 TIN / 20 x PH 2 x 25 TIN / 10 x PH 3 x 25 TIN			
10 x PZ 1 x 25 TIN / 20 x PZ 2 x 25 TIN / 10 x PZ 3 x 25 TIN			
10 x Torx® 10 x 25 TIN / 10 x Torx® 15 x 25 TIN / 10 x Torx® 20 x 25 TIN			
10 x Torx® 25 x 25 TIN / 10 x Torx® 30 x 25 TIN / 10 x Torx® 40 x 25 TIN			
10 x PZ 1 x 25 Diamant / 20 x PZ 2 x 25 DIA			
20 x PH 2 x 25 Diamant / 10 x PH 2 x 50 TIN			
10 x PZ 2 x 50 TIN			
10 x Torx® 15 x 50 TIN / 10 x Torx® 20 x 50 TIN / 10 x Torx® 25 x 50 TIN / 10 x Torx® 30 x 50 TIN			
6 x Adapter 6,3 1/4" 4-kt / 6 x Adapter 3/8" 50mm			
5 x Steckschlüssel Hex 8 x 66 / 5 x Steckschlüssel Hex 10 x 66 / 4 x Steckschlüssel Hex 13 x 66			
12 x Magnethalter 1/4" x 47 / 12 x Magnethalter 1/4" x 58			



## 020



1/4"

	Item No		EAN-Code
<b>Bit-Tray 284-pcs/ Zahlteiler</b> (275 x 270 x 33 mm)	<b>020 951 06</b>	2038	40 07157 51687 9
10 x PZ 1 x 25 / 20 x PZ 2 x 25 / 10 x PZ 3 x 25			
10 x PH 1 x 25 / 20 x PH 2 x 25 / 10 x PH 3 x 25			
10 x Torx® 15 x 25 / 10 x Torx® 20 x 25 / 10 x Torx® 25 x 25 / 10 x Torx® 30 x 25			
10 x PZ 1 x 25 TIN / 10 x PZ 2 x 25 TIN / 10 x PZ 3 x 25 TIN			
10 x PH 1 x 25 TIN / 10 x PH2 x 25 TIN / 10 x PH 3 x 25 TIN			
10 x PZ 1 x 50 / 10 x PZ 2 x 50			
10 x PH 1 x 50 / 10 x PH 2 x 50			
10 x 0,5 x 4,0 / 10 x 0,6 x 4,5 / 10 x 0,8 x 5,5			
12 x Magnethalter 1/4"			
6 x Adapter 1/4" x 25 mm / 6 x Adapter 3/8" x 50 mm / 6 x Adapter E 6,3 x 50 mm			
4 x Felo Star			

## Display **felo star**

**038**



		Item No		EAN-Code
<b>Felo Star Clipstrip</b> (850 x 50 mm)	1	<b>038 012 90</b>	494	40 07157 53049 3
(12 x )	038 165 94			

**038**



		Item No		EAN-Code
<b>Star Display</b> (345 x 245 x 170 mm)		<b>038 024 80</b>	1397	40 07157 51431 8
(24 x )	038 165 90			

**038**



		Item No		EAN-Code
<b>Impact / Star Display 24-pcs. 24-tlg</b>		<b>038 124 90</b>	2024	40 07157 63753 6
(12 x )	038 295 90			
(12 x )	038 165 90			



# Display **felo** *swift*



**038**

			Item No		EAN-Code
<b>Clipstrip Universal</b>	(85 x 10 cm)	1	<b>020 380 00</b>	1058	40 07157 53045 5
(12 x )	020 601 11				
<b>Clipstrip Torx®</b>	(85 x 10 cm)	1	<b>020 382 00</b>	1070	40 07157 53177 3
(12 x )	020 603 11				



**020**

			Item No		EAN-Code
<b>Holz TiN / Universal TiN</b>		1	<b>020 360 00</b>	2574	40 07157 51529 2
(18 x )	02060576 + 18 x 02060176				
<b>Universal / Torx®</b>		1	<b>020 363 00</b>	2610	40 07157 51535 3
(18 x )	02060116 + 18 x 02060316				
<b>Universal / Universal TiN</b>		1	<b>020 367 00</b>	2748	40 07157 51551 3
(18 x )	02060116 + 18 x 02060176				
<b>PZ PH TiN</b>		1	<b>020 368 00</b>	2784	40 07157 51611 4
(36 x )	02060376				

## Display empty / leer

391



empty / leer

Pliers Display / Zangen Display

Item No

391 058 00



1670

391



empty / leer

Storage Box / Bit-Schütte

Item No

391 015 00



4359

**391**



**empty / leer**

R-Go / XS Display

Item No  
391 010 00

  
4526

**391**



**empty / leer**

AllStar / swift Display

Item No  
391 043 00

  
1088

**391**



**empty / leer**

AllStar Display

Item No  
391 026 00

  
981

**391**



**empty / leer**

T-Handle Display, per hook / Display T-Griff, pro Haken

Item No  
391 024 00

  
153

**Sisteme inteligente de vânzări pentru comerciantul specializat și metode de prezentare a produselor ideale. Vă oferim consiliere profesionistă și putem concepe împreună o configurație pe măsura nevoilor dvs.**

*Intelligens értékesítési koncepciónk ideális megoldás a szakkereskedők számára. Szaktanácsokat adunk, és Önnel közösen dolgozzuk ki a termékek megjelenítését, szaküzletének megfelelően.*



**În plus față de produsele de dedesubt mai avem încă 120 de scule pentru profesioniști și 20 de clești de calitate în programul nostru.**

*Az alábbiakban felsorolt termékek mellett további 120 eszközünk van a szakemberek számára és további 20 minőségi fogó szerepel a választékunkban.*



**Scule Combinate:  
Alegeți dintre 28 de  
sortimente**

*Vălaszthat 28 féle  
kombinált  
szerszámkészletből*

**Șurubelnițe de precizie:  
Alegeți dintre 60 de  
scule și 9 seturi  
diferite sau  
10 display-uri**

*Preciziós csavarhúzó:  
Vălaszthat 60 féle egyedi  
csavarhúzóból és 9 féle  
csavarhúzó készletből*

**Seturi de Biți:  
Alegeți dintre 53 de  
seturi și 20 de  
display-uri**

*Bit készletek:  
Vălaszthat 53 féle  
készletből*

**Seturi de  
șurubelnițe:  
Alegeți dintre peste  
50 de variante**

*Csavarhúzó készletek:  
Több, mint 50 féle  
összeállításban*

**Șurubelnițe: Alegeți  
dintre 400 de șurubelnițe  
și 23 de display-uri  
complete**

*Csavarhúzó: Vălaszthat  
400 féle csavarhúzóból és  
23 féle feltöltött bemutató  
állványból*

**Biți: Alegeți dintre  
340 de biți și 50  
de variante ambalate  
la blister**

*Vălaszthat  
340 féle bitet*

**Șurubelnițe cu mâner  
în T: Alegeți dintre  
40 de șurubelnițe  
și 2 seturi**

*T-markolat:  
Vălaszthat 40 féle  
szerszámból és  
2 féle készletből*

**Display-urile pentru retail, cum ar fi modulele cu produse principale de 1 metru sunt modalități convingătoare și inteligente de vânzare, și sunt disponibile chiar și pentru spațiile limitate.**

*A bemutatófalak szabványos, egy méteres modulokként érhetők el, mely segítségével meggyőzően mutathatja be szerszámainkat még korlátozott helyeken is.*



**Autocolante în limbi diferite conținând pictograme informative ce explică foarte clar avantajele produselor! Autocolante pentru numărul articolului și preț.**

*A tájékoztató piktogramokkal ellátott magyar nyelvű matricák megkönnyítik a termékek beazonosítását. A matricák elláthatók rendelési számmal és árral is.*

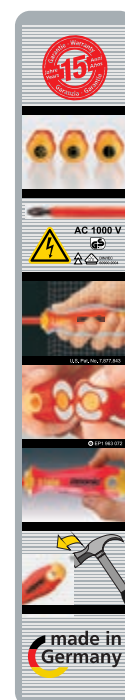

**Display-uri convingătoare pentru produsele mai mici: Display-urile noastre noi gata de vânzare Swift pentru plasarea pe tejghea**

*Kínáló állványok az apróbb eszközökhöz: Az új, eladást segítő Swift állványok kis helyet foglalnak a pultokon.*



**Felo Star**  
O cale sigură de a crește vânzările, datorită produselor inovatoare. Display-uri făcute din sticlă acrilică

*FELDO Star*  
Figyelemfelhívó állványok innovatív termékekkel.  
Kiváló minőségű akrilüvegből készült bemutató dobozok.



**Support POS convingător ce merge mână în mână cu orice linie nouă de produs**

*Meggyőző értékesítési támogatások az újonnan bevezetendő terméksaládoknak*



### **Partenerul dvs. pentru:**

- **Produse inovative**
- **Varietate extensivă**
- **Cele mai înalte standarde de calitate**
- **Suport pentru vânzare convingător**
- **Livrare rapidă**

*Az Ön partnere így hozzájuthat*

- *innovatív termékekhez*
- *széles választékhoz*
- *a legjobb minőségű szerszámokhoz*
- *szaktanácsainkhoz*
- *gyors szállításhoz*

## Artikkel Index / Tartalomjegyzék

Item No Art. Nr.	Page Seite	Item No Art. Nr.	Page Seite	Item No Art. Nr.	Page Seite
011 025 10	180	020 601 46	165	020 906 10	146
011 035 10	180	020 601 76	161	020 908 10	146
012 015 10	180	020 602 06	164	020 910 10	146
012 025 10	180	020 602 16	163	020 910 16	171
012 035 10	180	020 602 46	165	020 912 06	60
014 255 10	180	020 602 76	161	020 917 16	169
014 305 10	180	020 603 06	164	020 950 06	211
014 405 10	180	020 603 16	163	020 951 06	211
014 505 10	180	020 603 26	163	020 974 60	177
014 605 10	180	020 603 46	165	020 995 06	175
018 102 90	186	020 603 71	162	021 000 10	142
020 026 16	176	020 603 76	162	021 010 00	135
020 126 16	176	020 603 86	162	021 010 10	142
020 138 70	198	020 604 06	164	021 010 17	142
020 210 10	142	020 604 46	165	021 010 36	156
020 300 10	142	020 604 71	162	021 010 40	132
020 310 10	142	020 604 76	162	021 010 56	156
020 310 36	156	020 605 46	165	021 010 67	155
020 326 16	177	020 605 76	162	021 010 70	138
020 360 00	212	020 610 10	142	021 010 77	138
020 363 00	212	020 610 36	156	021 010 80	136
020 367 00	212	020 610 67	155	021 010 86	154
020 368 00	212	020 610 70	138	021 012 01	153
020 380 00	212	020 610 80	136	021 012 41	152
020 382 00	212	020 719 06	168	021 012 86	154
020 400 10	142	020 719 46	168	021 015 10	143
020 400 80	136	020 730 06	166	021 015 36	156
020 410 10	142	020 735 16	167	021 015 56	156
020 410 36	156	020 735 26	167	021 020 00	135
020 500 10	142	020 738 06	166	021 020 10	142
020 500 36	156	020 800 10	142	021 020 17	142
020 500 67	155	020 800 36	156	021 020 36	156
020 500 70	138	020 800 67	155	021 020 40	132
020 510 10	142	020 800 70	138	021 020 56	156
020 510 36	156	020 800 80	136	021 020 57	155
020 520 10	142	020 801 06	163	021 020 67	155
020 520 36	156	020 802 46	131	021 020 70	138
020 520 67	155	020 901 06	159	021 020 76	138
020 520 70	138	020 901 16	160	021 020 80	136
020 520 80	136	020 901 76	159	021 022 01	153
020 600 10	142	020 902 16	160	021 022 41	152
020 601 06	164	020 902 76	159	021 022 86	154
020 601 16	163	020 904 76	160	021 025 10	143



<b>Item No</b> <i>Art. Nr.</i>	<b>Page</b> <i>Seite</i>
021 025 36	156
021 025 56	156
021 026 16	176
021 030 00	135
021 030 10	142
021 030 17	142
021 030 36	156
021 030 40	132
021 030 56	156
021 030 67	155
021 030 70	138
021 030 77	138
021 030 80	136
021 030 86	154
021 032 01	153
021 032 41	152
021 032 86	154
021 035 10	143
021 035 36	156
021 035 56	156
021 042 10	142
021 042 36	156
021 910 76	170
021 932 16	156
021 932 67	155
021 932 86	154
022 000 10	142
022 002 10	143
022 002 70	139
022 010 00	135
022 010 10	142
022 010 17	142
022 010 36	156
022 010 40	132
022 010 56	156
022 010 67	155
022 010 70	138
022 010 77	138
022 010 80	136
022 010 86	154
022 012 01	153
022 012 41	152
022 015 10	143
022 015 36	157
022 015 56	157
022 020 00	135
022 020 10	142
022 020 17	142
022 020 36	156
022 020 40	132

<b>Item No</b> <i>Art. Nr.</i>	<b>Page</b> <i>Seite</i>
022 020 56	156
022 020 57	155
022 020 67	155
022 020 70	138
022 020 77	138
022 020 80	136
022 022 01	153
022 022 41	152
022 022 86	154
022 025 10	143
022 025 36	157
022 025 56	157
022 030 00	135
022 030 10	142
022 030 17	142
022 030 36	156
022 030 40	132
022 030 56	156
022 030 67	155
022 030 70	138
022 030 80	136
022 030 86	154
022 032 01	153
022 032 41	152
022 035 10	143
022 035 36	157
022 035 56	157
022 042 10	142
022 910 16	171
022 910 76	170
022 931 16	156
022 931 67	155
022 931 86	154
023 060 10	145
023 070 10	145
023 080 10	145
023 090 10	145
023 100 10	145
023 150 10	145
023 200 10	145
023 250 10	145
023 270 10	145
023 300 10	145
023 400 10	145
023 974 60	177
023 974 61	177
024 200 10	144
024 200 36	157
024 250 10	144
024 250 36	157

<b>Item No</b> <i>Art. Nr.</i>	<b>Page</b> <i>Seite</i>
024 300 10	144
024 300 36	157
024 400 10	144
024 400 36	157
024 400 56	157
024 500 10	144
024 500 36	157
024 550 10	144
024 600 10	144
024 600 36	157
024 800 10	144
024 800 36	157
025 000 10	144
025 100 10	144
025 200 10	144
025 300 10	144
026 050 10	144
026 050 36	157
026 060 10	144
026 060 36	157
026 060 70	139
026 070 10	144
026 070 36	157
026 070 70	139
026 080 10	144
026 080 36	157
026 080 70	139
026 090 10	144
026 090 36	157
026 090 70	139
026 100 00	135
026 100 10	144
026 100 17	144
026 100 36	157
026 100 40	132
026 100 67	155
026 100 70	139
026 100 80	137
026 100 86	154
026 102 01	153
026 102 41	152
026 150 00	135
026 150 10	144
026 150 17	144
026 150 36	157
026 150 40	132
026 150 67	155
026 150 70	139
026 150 77	139
026 150 80	137

<b>Item No</b> <i>Art. Nr.</i>	<b>Page</b> <i>Seite</i>
026 150 86	154
026 152 01	153
026 152 41	152
026 200 00	135
026 200 10	144
026 200 17	144
026 200 36	157
026 200 40	132
026 200 67	155
026 200 70	139
026 200 77	139
026 200 80	137
026 202 01	153
026 202 41	152
026 202 86	154
026 250 00	135
026 250 10	144
026 250 17	144
026 250 36	157
026 250 40	132
026 250 67	155
026 250 70	139
026 250 77	139
026 250 80	137
026 252 01	153
026 252 41	152
026 252 86	154
026 270 10	144
026 270 36	157
026 270 70	139
026 300 00	135
026 300 10	144
026 300 17	144
026 300 36	157
026 300 40	132
026 300 67	155
026 300 70	139
026 300 80	137
026 300 86	154
026 302 01	153
026 302 41	152
026 400 00	135
026 400 10	144
026 400 17	144
026 400 36	157
026 400 40	132
026 400 67	155
026 400 70	139
026 400 80	137
026 400 86	154

<b>Item No</b> <i>Art. Nr.</i>	<b>Page</b> <i>Seite</i>
026 402 01	153
026 402 41	152
026 450 10	144
026 450 70	139
026 500 10	144
026 501 10	144
026 910 16	171
026 931 16	157
026 933 16	157
026 933 67	155
026 933 86	154
027 070 10	145
027 080 10	145
027 090 10	145
027 100 10	145
027 150 10	145
027 200 10	145
027 250 10	145
027 270 10	145
027 300 10	145
027 400 10	145
028 040 10	146
028 050 10	146
028 060 10	146
028 080 10	146
028 100 10	146
028 930 10	145
028 940 10	145
029 000 10	146
029 010 10	146
029 020 10	146
029 030 10	146
029 040 10	146
029 050 10	146
029 060 10	146
029 080 10	146
029 100 10	146
029 300 10	178
029 400 10	178
029 500 10	178
029 510 10	146
029 520 10	146
029 530 10	146
029 540 10	146
029 550 10	146
029 600 10	178
030 105 10	147
030 305 10	147
030 307 10	149
030 315 10	147

<b>Item No</b> <i>Art. Nr.</i>	<b>Page</b> <i>Seite</i>
030 317 10	149
030 415 10	147
030 417 10	149
030 418 10	150
030 455 10	147
030 505 10	147
030 507 10	149
030 515 10	147
030 525 10	147
030 527 10	149
030 528 10	150
030 605 10	147
030 615 10	147
030 617 10	149
030 618 10	150
030 805 10	147
030 815 10	147
030 818 10	150
030 915 16	172
030 917 16	174
030 925 16	173
030 927 16	173
031 015 00	135
031 015 01	153
031 015 10	147
031 015 36	156
031 015 40	133
031 015 41	152
031 015 67	155
031 015 70	140
031 015 80	137
031 017 10	149
031 017 70	141
031 018 10	150
031 019 10	151
031 025 00	135
031 025 01	153
031 025 10	147
031 025 36	156
031 025 40	133
031 025 41	152
031 025 67	155
031 025 70	140
031 025 80	137
031 027 10	149
031 027 36	156
031 027 70	141
031 028 10	150
031 029 10	151
031 035 00	135

<b>Item No</b> <i>Art. Nr.</i>	<b>Page</b> <i>Seite</i>
<b>031 035 01</b>	<b>153</b>
<b>031 035 10</b>	<b>147</b>
<b>031 035 40</b>	<b>133</b>
<b>031 035 41</b>	<b>152</b>
<b>031 035 67</b>	<b>155</b>
<b>031 035 70</b>	<b>140</b>
<b>031 035 80</b>	<b>137</b>
<b>031 037 10</b>	<b>149</b>
<b>031 038 10</b>	<b>150</b>
<b>031 039 10</b>	<b>151</b>
<b>031 101 10</b>	<b>150</b>
<b>031 202 10</b>	<b>150</b>
<b>031 927 16</b>	<b>173</b>
<b>031 932 16</b>	<b>156</b>
<b>032 005 10</b>	<b>147</b>
<b>032 015 00</b>	<b>135</b>
<b>032 015 01</b>	<b>153</b>
<b>032 015 10</b>	<b>147</b>
<b>032 015 36</b>	<b>157</b>
<b>032 015 40</b>	<b>133</b>
<b>032 015 41</b>	<b>152</b>
<b>032 015 67</b>	<b>155</b>
<b>032 015 70</b>	<b>140</b>
<b>032 015 80</b>	<b>137</b>
<b>032 017 10</b>	<b>149</b>
<b>032 017 36</b>	<b>157</b>
<b>032 017 70</b>	<b>141</b>
<b>032 018 10</b>	<b>150</b>
<b>032 019 10</b>	<b>151</b>
<b>032 025 00</b>	<b>135</b>
<b>032 025 01</b>	<b>153</b>
<b>032 025 10</b>	<b>147</b>
<b>032 025 17</b>	<b>147</b>
<b>032 025 36</b>	<b>157</b>
<b>032 025 40</b>	<b>133</b>
<b>032 025 41</b>	<b>152</b>
<b>032 025 67</b>	<b>155</b>
<b>032 025 70</b>	<b>140</b>
<b>032 025 80</b>	<b>137</b>
<b>032 027 10</b>	<b>149</b>
<b>032 027 36</b>	<b>157</b>
<b>032 027 70</b>	<b>141</b>
<b>032 028 10</b>	<b>150</b>
<b>032 029 10</b>	<b>151</b>
<b>032 035 00</b>	<b>135</b>
<b>032 035 01</b>	<b>153</b>
<b>032 035 10</b>	<b>147</b>
<b>032 035 40</b>	<b>133</b>
<b>032 035 41</b>	<b>152</b>
<b>032 035 67</b>	<b>155</b>

<b>Item No</b> <i>Art. Nr.</i>	<b>Page</b> <i>Seite</i>
<b>032 035 70</b>	<b>140</b>
<b>032 035 80</b>	<b>137</b>
<b>032 037 10</b>	<b>149</b>
<b>032 101 10</b>	<b>150</b>
<b>032 202 10</b>	<b>150</b>
<b>032 915 16</b>	<b>172</b>
<b>032 915 76</b>	<b>170</b>
<b>032 917 16</b>	<b>174</b>
<b>032 927 16</b>	<b>174</b>
<b>032 931 16</b>	<b>157</b>
<b>033 105 10</b>	<b>147</b>
<b>033 155 10</b>	<b>147</b>
<b>033 205 10</b>	<b>147</b>
<b>033 255 10</b>	<b>147</b>
<b>033 305 10</b>	<b>147</b>
<b>034 255 10</b>	<b>148</b>
<b>034 305 10</b>	<b>148</b>
<b>034 405 10</b>	<b>148</b>
<b>034 505 10</b>	<b>148</b>
<b>034 605 10</b>	<b>148</b>
<b>034 805 10</b>	<b>148</b>
<b>035 007 10</b>	<b>149</b>
<b>035 017 10</b>	<b>149</b>
<b>035 027 10</b>	<b>149</b>
<b>035 037 10</b>	<b>149</b>
<b>035 105 10</b>	<b>148</b>
<b>035 205 10</b>	<b>148</b>
<b>035 305 10</b>	<b>148</b>
<b>036 055 10</b>	<b>148</b>
<b>036 065 10</b>	<b>148</b>
<b>036 075 10</b>	<b>148</b>
<b>036 085 10</b>	<b>148</b>
<b>036 095 10</b>	<b>148</b>
<b>036 100 10</b>	<b>151</b>
<b>036 105 10</b>	<b>148</b>
<b>036 105 40</b>	<b>133</b>
<b>036 105 41</b>	<b>152</b>
<b>036 105 70</b>	<b>140</b>
<b>036 107 10</b>	<b>149</b>
<b>036 150 10</b>	<b>151</b>
<b>036 155 10</b>	<b>148</b>
<b>036 155 36</b>	<b>157</b>
<b>036 155 40</b>	<b>133</b>
<b>036 155 41</b>	<b>152</b>
<b>036 155 70</b>	<b>140</b>
<b>036 157 10</b>	<b>149</b>
<b>036 200 10</b>	<b>151</b>
<b>036 205 10</b>	<b>148</b>
<b>036 205 36</b>	<b>157</b>
<b>036 205 40</b>	<b>133</b>

<b>Item No</b> <i>Art. Nr.</i>	<b>Page</b> <i>Seite</i>
<b>036 205 41</b>	<b>152</b>
<b>036 205 70</b>	<b>140</b>
<b>036 207 10</b>	<b>149</b>
<b>036 209 10</b>	<b>150</b>
<b>036 250 10</b>	<b>151</b>
<b>036 255 10</b>	<b>148</b>
<b>036 255 36</b>	<b>157</b>
<b>036 255 40</b>	<b>133</b>
<b>036 255 41</b>	<b>152</b>
<b>036 255 70</b>	<b>140</b>
<b>036 257 10</b>	<b>149</b>
<b>036 259 10</b>	<b>150</b>
<b>036 275 10</b>	<b>148</b>
<b>036 277 10</b>	<b>149</b>
<b>036 300 10</b>	<b>151</b>
<b>036 305 10</b>	<b>148</b>
<b>036 305 36</b>	<b>157</b>
<b>036 305 40</b>	<b>133</b>
<b>036 305 41</b>	<b>152</b>
<b>036 305 70</b>	<b>140</b>
<b>036 307 10</b>	<b>149</b>
<b>036 309 10</b>	<b>150</b>
<b>036 405 10</b>	<b>148</b>
<b>036 405 40</b>	<b>133</b>
<b>036 405 41</b>	<b>152</b>
<b>036 405 70</b>	<b>140</b>
<b>036 407 10</b>	<b>149</b>
<b>036 915 16</b>	<b>172</b>
<b>036 915 46</b>	<b>169</b>
<b>036 915 76</b>	<b>170</b>
<b>036 917 16</b>	<b>175</b>
<b>036 925 46</b>	<b>169</b>
<b>036 931 16</b>	<b>157</b>
<b>036 932 16</b>	<b>157</b>
<b>036 935 46</b>	<b>169</b>
<b>036 945 46</b>	<b>169</b>
<b>037 103 90</b>	<b>186</b>
<b>038 012 90</b>	<b>212</b>
<b>038 024 80</b>	<b>212</b>
<b>038 102 90</b>	<b>185</b>
<b>038 103 90</b>	<b>185</b>
<b>038 103 96</b>	<b>157</b>
<b>038 105 90</b>	<b>185</b>
<b>038 107 90</b>	<b>185</b>
<b>038 108 90</b>	<b>185</b>
<b>038 109 90</b>	<b>185</b>
<b>038 124 90</b>	<b>212</b>
<b>038 165 90</b>	<b>158</b>
<b>038 165 94</b>	<b>158</b>
<b>038 169 90</b>	<b>158</b>

<b>Item No</b> <i>Art. Nr.</i>	<b>Page</b> <i>Seite</i>
038 170 90	158
038 200 10	183
038 200 20	183
038 224 90	210
038 295 90	131
038 295 94	131
039 038 10	179
039 050 10	179
039 060 10	179
039 070 10	179
039 070 16	157
039 080 10	179
039 080 16	157
039 090 10	179
039 100 10	179
039 100 16	157
039 110 10	179
039 120 10	179
039 130 10	179
039 130 16	157
039 516 10	179
039 961 06	179
048 102 80	186
057 635 01	120
057 711 06	117
057 711 56	119
057 718 06	117
057 718 56	119
057 718 66	44
057 733 06	118
057 810 06	111
057 819 06	111
057 819 56	115
057 827 06	112
057 836 06	113
057 836 16	110
057 836 56	114
057 981 06	175
058 102 90	186
059 103 90	186
060 809 04	124
060 813 06	124
060 815 06	125
060 820 06	126
060 920 36	127
061 105 04	129
061 126 10	181
061 206 04	129
061 226 10	181
061 236 10	181

<b>Item No</b> <i>Art. Nr.</i>	<b>Page</b> <i>Seite</i>
061 307 04	129
062 023 04	129
062 104 04	129
062 107 04	129
062 126 10	181
062 206 04	129
062 226 10	181
062 236 10	181
063 000 04	71
063 025 04	71
063 030 04	71
063 035 04	71
063 040 04	71
063 055 04	71
063 065 04	71
063 083 04	71
063 100 04	71
063 102 04	71
063 102 14	71
063 103 04	71
063 105 00	71
063 112 04	71
063 112 14	71
063 153 04	71
063 200 04	71
063 203 04	71
063 203 14	71
063 203 24	71
063 223 04	71
063 223 14	71
063 255 10	181
063 300 04	71
063 913 01	68
063 913 06	68
063 913 16	69
063 919 04	70
063 999 01	69
064 034 04	129
064 056 04	129
065 001 04	129
065 023 04	129
066 067 04	129
066 089 04	129
066 115 04	129
066 225 04	129
066 340 04	129
067 115 04	129
067 225 04	129
067 340 04	129
068 055 04	128

<b>Item No</b> <i>Art. Nr.</i>	<b>Page</b> <i>Seite</i>
068 055 24	129
068 060 04	128
068 060 24	129
068 070 04	128
068 070 24	129
068 080 04	128
068 080 24	129
068 100 04	128
068 100 24	129
068 110 04	128
068 111 04	128
068 127 04	128
068 130 04	128
068 130 24	129
068 142 04	128
068 170 04	128
068 170 24	129
068 555 04	128
068 635 04	128
068 635 14	129
068 714 04	128
068 793 04	128
068 952 04	128
069 205 00	127
070 104 10	181
070 204 10	181
070 514 10	181
070 524 10	181
070 604 10	181
070 614 10	181
070 804 10	181
070 814 10	181
071 010 10	181
071 020 10	181
071 030 10	181
071 042 10	181
072 010 10	182
072 020 10	182
072 030 10	182
072 042 10	182
074 100 10	182
074 300 10	182
074 400 10	182
074 500 10	182
074 600 10	182
074 800 10	182
076 253 10	182
076 273 10	182
076 303 10	182
076 403 10	182

<b>Item No</b> <i>Art. Nr.</i>	<b>Page</b> <i>Seite</i>
076 453 10	182
076 503 10	182
076 553 10	182
078 005 10	182
078 006 10	182
078 008 10	182
078 010 10	182
078 012 10	182
078 050 10	182
078 060 10	182
078 080 10	182
078 100 10	182
078 120 10	182
079 080 10	178
079 100 10	178
081 020 10	183
081 025 10	183
082 020 10	183
082 020 20	183
082 025 10	183
082 225 10	183
086 020 10	183
086 025 10	183
086 200 10	183
086 250 10	183
096 040 10	121
096 045 10	121
096 050 10	121
096 055 10	121
096 055 20	115
096 060 10	121
096 060 20	115
096 070 10	121
096 070 20	115
096 080 10	121
096 080 20	115
096 090 10	121
096 100 10	121
096 100 20	115
096 110 10	121
096 120 10	121
096 130 10	121
096 130 20	115
096 140 10	121
096 200 10	121
096 210 10	121
096 220 10	121
096 230 10	121
096 240 10	121
096 250 10	121

<b>Item No</b> <i>Art. Nr.</i>	<b>Page</b> <i>Seite</i>
096 260 10	121
096 270 10	121
096 280 10	121
096 290 10	121
096 300 10	121
096 310 10	121
096 320 10	121
097 000 10	121
097 011 10	187
097 013 10	187
097 018 10	187
097 019 10	121
097 020 10	187
097 050 10	120
097 070 10	187
097 100 10	120
097 150 14	129
100 001 06	85
100 002 06	85
100 003 06	85
100 006 00	85
100 032 04	86
100 043 04	86
100 043 94	70
100 060 00	85
100 353 04	86
100 353 94	70
100 554 04	86
100 554 94	70
100 991 16	83
100 992 16	83
100 993 16	84
101 001 04	86
101 102 04	86
101 102 94	70
101 203 04	86
101 203 94	70
102 001 04	86
102 102 04	86
102 102 94	70
102 203 04	86
102 203 94	70
104 015 04	86
104 020 04	86
104 025 04	86
104 030 04	86
104 040 04	86
106 102 04	86
106 203 04	86
106 203 94	70

<b>Item No</b> <i>Art. Nr.</i>	<b>Page</b> <i>Seite</i>
107 102 04	86
107 102 94	70
107 203 04	86
107 203 94	70
108 061 04	86
108 071 04	86
108 083 04	86
108 093 04	86
108 103 04	86
108 153 04	86
108 203 04	86
108 253 04	86
109 061 04	86
109 071 04	86
109 083 04	86
109 093 04	86
109 103 04	86
109 153 04	86
109 203 04	86
109 253 04	86
118 125 04	86
197 170 04	85
200 022 90	37
200 032 90	37
200 043 90	37
200 054 90	37
200 086 90	37
200 107 90	37
200 112 96	40
200 114 96	41
200 353 90	37
200 550 90	37
200 554 90	37
200 650 90	37
200 654 90	37
200 655 90	37
200 951 98	38
200 971 97	39
200 972 97	40
200 972 98	38
200 973 98	39
200 994 90	205
200 997 90	206
201 001 90	37
201 020 90	37
201 102 90	37
201 203 90	37
201 305 90	37
202 001 90	37
202 020 90	37

<b>Item No</b> <i>Art. Nr.</i>	<b>Page</b> <i>Seite</i>
202 102 90	37
202 203 90	37
202 305 90	37
206 055 90	35
206 065 90	35
206 080 90	35
206 100 90	35
206 120 90	35
206 951 98	35
206 992 90	205
208 061 90	38
208 071 90	38
208 083 90	38
208 093 90	38
208 103 90	38
208 153 90	38
208 203 90	38
208 253 90	38
208 273 90	38
208 303 90	38
208 404 90	38
208 971 98	39
208 991 90	206
216 203 90	35
216 305 90	35
226 203 90	35
226 305 90	35
240 033 50	89
240 035 50	89
240 037 50	89
240 043 50	89
240 045 50	89
240 047 50	89
240 151 50	89
240 201 50	89
240 252 50	89
240 255 50	89
240 257 50	89
240 333 50	89
240 353 50	89
240 355 50	89
240 358 50	89
240 951 50	208
240 961 50	207
240 961 56	91
240 990 50	207
241 001 50	89
241 102 50	89
242 000 50	89
242 001 50	89

<b>Item No</b> <i>Art. Nr.</i>	<b>Page</b> <i>Seite</i>
242 009 50	89
242 102 50	89
242 105 50	89
243 021 50	90
243 051 50	90
243 061 50	90
243 961 56	91
245 102 50	90
245 961 06	91
246 151 50	90
246 201 50	90
246 252 50	90
246 302 50	90
248 051 50	90
248 061 50	90
248 071 50	90
248 081 50	90
248 091 50	90
248 103 50	90
248 108 50	90
248 153 50	90
248 158 50	90
248 208 50	90
248 961 56	91
249 300 50	90
249 350 50	90
249 400 50	90
249 450 50	90
249 500 50	90
249 550 50	90
249 961 56	91
250 033 80	93
250 035 80	93
250 151 80	93
250 201 80	93
250 252 80	93
250 961 80	209
250 961 86	93
252 001 80	93
252 009 80	93
252 102 80	93
280 153 14	92
280 235 14	92
280 245 14	92
280 907 06	92
280 907 16	92
280 907 26	92
280 961 10	208
281 010 14	92
282 000 14	92

<b>Item No</b> <i>Art. Nr.</i>	<b>Page</b> <i>Seite</i>
282 001 14	92
284 134 14	92
284 152 14	92
284 253 14	92
286 615 14	92
286 710 14	92
286 890 14	92
303 035 80	97
303 045 80	97
303 055 80	97
303 065 80	97
303 085 80	97
303 087 80	97
303 107 80	97
303 203 80	97
303 253 80	97
304 064 80	97
304 068 80	97
304 078 80	97
304 084 80	97
304 088 80	97
304 089 80	97
304 098 80	97
304 104 80	97
304 108 80	97
304 109 80	97
304 118 80	97
304 128 80	97
304 134 80	97
304 138 80	97
304 139 80	97
304 178 80	97
304 558 80	97
308 103 80	98
308 153 80	98
308 204 80	98
308 207 80	98
308 254 80	98
308 257 80	98
308 277 80	98
308 307 80	98
308 407 80	98
308 455 80	98
326 965 10	45
326 965 11	45
335 035 90	43
335 045 90	43
335 055 90	43
335 065 90	43
335 080 90	43

<b>Item No</b> <i>Art. Nr.</i>	<b>Page</b> <i>Seite</i>
<b>335 100 90</b>	<b>43</b>
<b>335 120 90</b>	<b>43</b>
<b>335 951 98</b>	<b>43</b>
<b>335 952 98</b>	<b>44</b>
<b>335 971 98</b>	<b>44</b>
<b>335 991 90</b>	<b>209</b>
<b>336 102 90</b>	<b>43</b>
<b>336 203 90</b>	<b>43</b>
<b>336 305 90</b>	<b>43</b>
<b>337 102 90</b>	<b>43</b>
<b>337 203 90</b>	<b>43</b>
<b>337 305 90</b>	<b>43</b>
<b>338 125 80</b>	<b>98</b>
<b>340 040 00</b>	<b>99</b>
<b>340 040 04</b>	<b>99</b>
<b>340 055 00</b>	<b>99</b>
<b>340 055 04</b>	<b>99</b>
<b>340 080 00</b>	<b>99</b>
<b>340 080 04</b>	<b>99</b>
<b>341 120 00</b>	<b>99</b>
<b>341 120 04</b>	<b>99</b>
<b>341 340 00</b>	<b>99</b>
<b>341 340 04</b>	<b>99</b>
<b>342 120 00</b>	<b>99</b>
<b>342 120 04</b>	<b>99</b>
<b>342 340 00</b>	<b>99</b>
<b>342 340 04</b>	<b>99</b>
<b>343 260 00</b>	<b>99</b>
<b>343 260 04</b>	<b>99</b>
<b>345 006 01</b>	<b>106</b>
<b>345 007 01</b>	<b>106</b>
<b>345 015 00</b>	<b>104</b>
<b>345 020 00</b>	<b>104</b>
<b>345 025 00</b>	<b>104</b>
<b>345 030 00</b>	<b>104</b>
<b>345 040 00</b>	<b>104</b>
<b>345 050 00</b>	<b>104</b>
<b>345 060 00</b>	<b>104</b>
<b>345 080 00</b>	<b>104</b>
<b>345 100 00</b>	<b>104</b>
<b>345 120 00</b>	<b>104</b>
<b>345 140 00</b>	<b>104</b>
<b>345 170 00</b>	<b>104</b>
<b>348 006 00</b>	<b>102</b>
<b>348 007 00</b>	<b>102</b>
<b>348 008 00</b>	<b>102</b>
<b>348 009 00</b>	<b>102</b>
<b>348 010 00</b>	<b>102</b>
<b>348 015 00</b>	<b>102</b>
<b>348 020 00</b>	<b>102</b>

<b>Item No</b> <i>Art. Nr.</i>	<b>Page</b> <i>Seite</i>
<b>348 025 00</b>	<b>102</b>
<b>348 027 00</b>	<b>102</b>
<b>348 030 00</b>	<b>102</b>
<b>348 040 00</b>	<b>102</b>
<b>348 045 00</b>	<b>102</b>
<b>348 050 00</b>	<b>102</b>
<b>348 055 00</b>	<b>102</b>
<b>348 060 00</b>	<b>102</b>
<b>348 080 01</b>	<b>103</b>
<b>348 088 01</b>	<b>103</b>
<b>348 105 50</b>	<b>101</b>
<b>348 106 50</b>	<b>101</b>
<b>348 107 50</b>	<b>101</b>
<b>348 108 50</b>	<b>101</b>
<b>348 109 50</b>	<b>101</b>
<b>348 110 50</b>	<b>101</b>
<b>348 115 50</b>	<b>101</b>
<b>348 120 50</b>	<b>101</b>
<b>348 888 01</b>	<b>102</b>
<b>348 907 50</b>	<b>101</b>
<b>349 105 50</b>	<b>101</b>
<b>349 106 50</b>	<b>101</b>
<b>349 107 50</b>	<b>101</b>
<b>349 108 50</b>	<b>101</b>
<b>349 109 50</b>	<b>101</b>
<b>349 110 50</b>	<b>101</b>
<b>349 115 50</b>	<b>101</b>
<b>349 120 50</b>	<b>101</b>
<b>349 907 50</b>	<b>102</b>
<b>355 009 01</b>	<b>107</b>
<b>355 015 00</b>	<b>104</b>
<b>355 020 00</b>	<b>104</b>
<b>355 025 00</b>	<b>104</b>
<b>355 030 00</b>	<b>104</b>
<b>355 040 00</b>	<b>104</b>
<b>355 050 00</b>	<b>104</b>
<b>355 060 00</b>	<b>104</b>
<b>355 080 00</b>	<b>104</b>
<b>355 100 00</b>	<b>104</b>
<b>355 150 01</b>	<b>107</b>
<b>361 300 00</b>	<b>73</b>
<b>361 300 01</b>	<b>73</b>
<b>361 350 00</b>	<b>73</b>
<b>361 350 01</b>	<b>73</b>
<b>361 400 00</b>	<b>72</b>
<b>361 400 01</b>	<b>72</b>
<b>361 600 00</b>	<b>73</b>
<b>361 600 04</b>	<b>73</b>
<b>361 700 00</b>	<b>73</b>
<b>361 700 04</b>	<b>73</b>

<b>Item No</b> <i>Art. Nr.</i>	<b>Page</b> <i>Seite</i>
<b>363 100 05</b>	<b>73</b>
<b>365 009 01</b>	<b>105</b>
<b>365 015 00</b>	<b>105</b>
<b>365 020 00</b>	<b>105</b>
<b>365 025 00</b>	<b>105</b>
<b>365 030 00</b>	<b>105</b>
<b>365 040 00</b>	<b>105</b>
<b>365 050 00</b>	<b>105</b>
<b>365 060 00</b>	<b>105</b>
<b>365 080 00</b>	<b>105</b>
<b>365 100 00</b>	<b>105</b>
<b>373 108 05</b>	<b>95</b>
<b>373 208 05</b>	<b>95</b>
<b>374 004 05</b>	<b>95</b>
<b>374 204 05</b>	<b>95</b>
<b>375 130 01</b>	<b>107</b>
<b>376 041 05</b>	<b>95</b>
<b>376 044 05</b>	<b>95</b>
<b>376 912 00</b>	<b>199</b>
<b>389 800 01</b>	<b>120</b>
<b>389 900 00</b>	<b>127</b>
<b>391 010 00</b>	<b>215</b>
<b>391 011 00</b>	<b>200</b>
<b>391 014 00</b>	<b>202</b>
<b>391 015 00</b>	<b>214</b>
<b>391 020 00</b>	<b>207</b>
<b>391 023 00</b>	<b>207</b>
<b>391 023 50</b>	<b>208</b>
<b>391 024 00</b>	<b>215</b>
<b>391 026 00</b>	<b>215</b>
<b>391 043 00</b>	<b>215</b>
<b>391 058 00</b>	<b>214</b>
<b>391 091 00</b>	<b>197</b>
<b>391 818 90</b>	<b>210</b>
<b>397 127 80</b>	<b>98</b>
<b>397 635 80</b>	<b>98</b>
<b>397 952 80</b>	<b>98</b>
<b>400 022 10</b>	<b>8</b>
<b>400 032 10</b>	<b>8</b>
<b>400 043 10</b>	<b>8</b>
<b>400 055 10</b>	<b>8</b>
<b>400 063 10</b>	<b>8</b>
<b>400 065 10</b>	<b>8</b>
<b>400 067 10</b>	<b>8</b>
<b>400 086 10</b>	<b>8</b>
<b>400 106 36</b>	<b>13</b>
<b>400 107 10</b>	<b>8</b>
<b>400 206 36</b>	<b>13</b>
<b>400 353 10</b>	<b>8</b>
<b>400 550 10</b>	<b>11</b>

<b>Item No</b> <i>Art. Nr.</i>	<b>Page</b> <i>Seite</i>
400 554 10	8
400 555 10	8
400 653 10	8
400 655 10	8
400 657 10	8
400 905 10	198
400 907 10	198
400 910 13	12
400 910 43	12
400 917 43	12
400 931 18	15
400 951 18	14
400 953 18	14
400 961 18	14
400 971 18	13
400 991 10	200
401 102 10	8
401 203 10	8
401 305 10	8
401 951 48	15
402 020 10	11
402 102 10	9
402 203 10	9
402 205 10	9
402 207 10	9
402 305 10	9
402 951 48	15
404 000 40	9
404 100 40	9
404 200 40	9
404 300 40	9
404 931 48	15
407 103 40	9
407 153 40	9
407 203 40	9
407 253 40	9
408 071 40	9
408 083 40	9
408 093 40	9
408 103 40	9
408 153 40	9
408 203 40	9
408 253 40	9
408 273 40	9
408 303 40	9
408 404 40	9
408 931 48	16
408 961 48	16
408 962 48	16
410 042 40	6

<b>Item No</b> <i>Art. Nr.</i>	<b>Page</b> <i>Seite</i>
410 085 40	6
410 105 40	6
410 553 40	6
410 127 40	6
410 654 40	6
410 961 48	6
410 962 48	7
410 963 48	7
410 991 40	200
411 102 40	6
411 203 40	6
411 305 40	6
412 102 40	6
412 203 40	6
412 305 40	6
412 405 40	6
413 025 90	53
413 030 90	53
413 035 90	53
413 038 90	53
413 040 90	53
413 045 90	53
413 055 90	53
413 065 90	53
413 080 90	53
413 106 36	56
413 807 36	50
413 811 04	79
413 841 98	49
413 851 98	50
413 852 98	49
413 881 90	51
413 905 90	198
413 907 90	198
413 910 93	51
413 911 04	79
413 930 90	48
413 931 94	55
413 935 90	48
413 938 90	48
413 940 90	48
413 945 90	48
413 985 17	80
413 955 90	48
413 961 98	55
413 963 98	55
413 965 90	48
413 991 90	201
413 995 04	80
414 001 90	53

<b>Item No</b> <i>Art. Nr.</i>	<b>Page</b> <i>Seite</i>
414 102 90	53
414 192 90	48
414 203 90	53
414 293 90	48
414 304 90	53
414 910 93	56
415 102 90	53
415 192 90	48
415 203 90	53
415 293 90	48
415 304 90	53
416 102 90	54
416 192 90	48
416 203 90	54
416 293 90	48
417 102 90	54
417 192 90	48
417 203 90	54
417 921 91	54
417 293 90	48
418 103 90	54
418 109 90	49
418 153 90	54
418 159 90	49
418 203 90	54
418 209 90	49
418 253 90	54
418 259 90	49
418 303 90	54
419 055 30	57
419 060 30	57
419 070 30	57
419 080 30	57
419 100 30	57
419 100 90	54
419 106 36	57
419 130 30	57
419 190 90	49
419 200 90	54
419 290 90	49
428 055 30	10
428 060 30	10
428 070 30	10
428 080 30	10
428 100 30	10
428 106 36	17
428 130 30	10
429 050 40	10
429 060 40	10
429 070 40	10



<b>Item No</b> <i>Art. Nr.</i>	<b>Page</b> <i>Seite</i>
429 080 40	10
429 100 40	10
429 635 40	10
438 025 40	120
438 026 40	11
438 125 40	11
490 041 10	45
493 063 10	45
494 003 30	45
497 110 40	11
497 200 00	11
497 635 41	115
498 063 10	45
500 022 10	23
500 032 10	23
500 032 30	26
500 037 30	26
500 043 10	23
500 043 30	26
500 047 10	23
500 047 30	26
500 049 10	23
500 086 10	23
500 088 10	23
500 096 10	23
500 107 10	23
500 111 16	33
500 112 16	33
500 353 10	23
500 353 30	26
500 358 30	26
500 504 10	23
500 505 10	23
500 550 10	24
500 554 10	23
500 556 10	23
500 557 10	23
500 559 10	23
500 610 10	23
500 655 10	23
500 656 10	23
500 657 10	23
500 924 00	32
500 931 14	31
500 933 34	30
500 934 14	31
500 951 18	31
500 961 17	29
500 963 17	29
500 971 18	32

<b>Item No</b> <i>Art. Nr.</i>	<b>Page</b> <i>Seite</i>
500 971 37	30
500 991 30	203
500 992 10	201
500 994 10	202
501 001 10	23
501 010 10	24
501 020 10	24
501 102 10	23
501 102 30	26
501 203 10	23
501 203 30	26
501 207 10	23
501 207 30	26
501 209 10	23
501 305 10	23
502 001 10	23
502 010 10	24
502 020 10	24
502 102 10	23
502 102 30	26
502 107 10	23
502 107 30	26
502 203 10	23
502 203 30	26
502 205 10	23
502 207 10	23
502 207 30	26
502 209 10	23
502 210 10	23
502 305 10	23
507 103 40	24
507 153 40	24
507 203 40	24
507 253 40	24
507 273 40	24
507 303 40	24
507 404 40	24
507 961 48	32
508 051 40	25
508 061 40	25
508 071 40	25
508 083 40	25
508 093 40	25
508 103 30	26
508 103 40	25
508 153 30	26
508 153 40	25
508 203 30	26
508 203 40	25
508 253 30	26

<b>Item No</b> <i>Art. Nr.</i>	<b>Page</b> <i>Seite</i>
508 253 40	25
508 273 40	25
508 303 40	25
508 404 40	25
508 454 40	25
508 912 40	203
508 931 34	31
508 961 47	29
508 971 47	30
509 061 40	25
509 071 40	25
509 083 40	25
509 093 40	25
509 103 40	25
509 153 40	25
509 203 40	25
509 253 40	25
509 273 40	25
509 303 40	25
509 404 40	25
511 405 40	23
513 025 90	59
513 030 90	59
513 035 90	59
513 040 90	59
513 045 90	59
513 055 90	59
513 065 90	59
513 080 90	59
513 931 14	61
513 951 98	61
513 956 98	61
513 961 97	60
513 961 98	60
513 991 90	203
514 001 90	59
514 102 90	59
514 203 90	59
514 304 90	59
515 102 90	59
515 203 90	59
515 304 90	59
518 125 90	59
520 045 10	27
520 055 10	27
522 105 10	27
522 205 10	27
527 202 40	28
527 253 40	28
527 303 40	28

<b>Item No</b> <i>Art. Nr.</i>	<b>Page</b> <i>Seite</i>
527 403 40	28
527 503 40	28
527 604 40	28
527 805 40	28
528 040 40	28
528 050 40	28
528 055 40	28
528 058 40	28
528 060 40	28
528 068 40	28
528 070 40	28
528 078 40	28
528 080 40	28
528 090 40	28
528 100 40	28
528 110 40	28
528 120 40	28
528 130 40	28
528 140 40	28
538 100 40	27
538 125 40	28
550 045 40	19
550 055 40	19
550 065 40	19
550 080 40	19
550 090 40	19
550 100 40	19
550 120 40	19
550 932 44	21
550 951 48	20
550 952 48	20
550 961 47	20
550 993 40	202

<b>Item No</b> <i>Art. Nr.</i>	<b>Page</b> <i>Seite</i>
551 102 40	19
551 203 40	19
551 305 40	19
552 102 40	19
552 203 40	19
552 305 40	19
580 001 00	78
580 016 40	76
580 018 40	76
581 016 40	76
581 018 40	76
581 020 40	77
582 017 40	76
582 225 40	76
583 016 40	77
583 999 11	81
584 016 40	77
584 018 11	81
586 018 40	78
590 016 40	190
590 018 40	190
591 014 40	190
591 016 40	190
591 018 40	190
591 020 40	191
591 118 40	190
592 020 40	190
592 220 40	190
597 200 00	28
600 110 96	65
613 025 90	63
613 030 90	63
613 035 90	63

<b>Item No</b> <i>Art. Nr.</i>	<b>Page</b> <i>Seite</i>
613 040 90	63
613 055 90	63
613 065 90	63
613 080 90	63
613 090 90	63
613 100 90	63
613 962 98	65
613 973 97	64
613 974 97	64
613 992 90	204
614 001 90	63
614 102 90	63
614 203 90	63
614 304 90	63
615 001 90	63
615 102 90	63
615 203 90	63
615 304 90	63
894 020 40	191
895 025 40	191
895 250 40	191
895 300 40	191

# Verkaufs- und Lieferbedingungen

Nachstehende Lieferbedingungen gelten durch Auftragserteilung als vereinbart. Hier von abweichende Vereinbarungen werden erst durch unsere schriftliche Bestätigung gültig. Sie haben den übrigen Teil der Verkaufs- und Lieferbedingungen nicht auf.

## 1. Angebot und Vertragsabschluss

Unsere Angebote sind freibleibend, Verträge und sonstige Vereinbarungen werden erst durch unsere schriftliche Bestätigung oder durch unsere Lieferung/Leistung verbindlich. Sämtliche Vereinbarungen zwischen uns und unseren Kunden sind bei Vertragsabschluss schriftlich niederzulegen. Bei oder nach Vertragsabschluss getroffene Vereinbarungen zwischen unseren Mitarbeitern oder Vertretern und unseren Kunden bedürfen zu ihrer Gültigkeit unserer schriftlichen Bestätigung; die Vertretungsmacht unserer Mitarbeiter und Vertreter ist insoweit eingeschränkt. Ergänzungen, Änderungen oder Nebenabreden bedürfen ebenfalls der Schriftform. Dies gilt auch für die Aufhebung des Schriftformerfordernisses.

## 2. Lieferverpflichtung

Voraussetzung für die Lieferverpflichtung ist die unbedingte Kreditwürdigkeit des Kunden. Werden die Zahlungsbedingungen nicht eingehalten oder werden Umstände bekannt, die die Kreditwürdigkeit des Kunden ernsthaft in Frage stellen oder wird ein Scheck nicht eingelöst, so werden sämtliche offen stehende Forderungen fällig. Nach fruchtlosem Ablauf einer von uns gesetzten Nachfrist, auch ohne Kündigungsandrohung, sind wir berechtigt, den Vertrag schriftlich zu kündigen und die Lieferungen einzustellen sowie alle bisher erbrachten Lieferungen abzubrechen. Teillieferungen sind zulässig.

Bei Sonderanfertigungen behalten wir uns eine Mehr- oder Minderlieferung von 10 % vor; auch für den Fall, dass Teillieferungen bereits erfolgten oder noch erfolgen. Bestellungen auf Abruf sind, wenn nichts anderes schriftlich vereinbart ist, spätestens innerhalb von einem viertel Jahr nach Ablauf der Vertragsfrist abzunehmen, ohne dass wir die Abnahme unter Fristsetzung anmahnen. Nach Ablauf dieser 3 Monate sind wir berechtigt, nach unserer Wahl entweder die Ware in Rechnung zu stellen oder den Auftrag zu streichen. Störungen und Ereignisse höherer Gewalt berechtigen uns, die eingegangene Lieferfrist für die Dauer der Betriebsverhinderung und einer angemessenen Anlaufzeit zu verlängern. Unter Umständen können auch unsere Lieferverpflichtungen ganz oder teilweise aufgehoben werden. Dies gilt auch, wenn uns die Lieferung unmöglich geworden ist, ohne dass wir dieses zu vertreten haben. Der Kunde kann von uns dann die Erklärung verlangen, ob wir zurücktreten oder innerhalb angemessener Frist liefern. Die Geltendmachung von Ersatzansprüchen in irgendeiner Art infolge verspäteter Lieferung ist auf einen Maximalwert von 5 % des Auftragswertes beschränkt.

## 3. Lieferzeit

Die Lieferzeit ist eingehalten, wenn bis zu ihrem Ablauf die Versandbereitschaft mitgeteilt ist, oder der Liefergegenstand das Werk verlassen hat. Der in der Auftragsbestätigung genannte Termin ist freibleibend, wenn nicht eine gesonderte schriftliche Lieferzusicherung erfolgt ist.

## 4. Preise

Unsere Preise beruhen auf den zum Zeitpunkt der Auftragsannahme gültigen Kalkulationsunterlagen. Lieferungen, die später als 4 Monate nach Vertragsabschluss erbracht werden, berechtigen uns, z.B. bei Lohnund/ oder Materialpreiserhöhungen, eine Anpassung der Preise bis zu maximal 5 % vorzunehmen.

## 5. Transport

Die Wahl des Transportweges und der Transportmittel erfolgt nach bestem Ermessen ohne Haftung für den billigsten Weg. Sofern uns besondere Vorschriften gegeben werden, erfolgt der Versand entsprechend. Das Transportrisiko trägt in jedem Fall der Empfänger, auch dann, wenn die Lieferung frei Empfangsort oder FOB eines Schiffes vereinbart wird. Mit Verlassen des Werkes wird die Ware als bedingungsgemäß geliefert betrachtet, auch wenn sie unmittelbar an Dritte gesandt wird.

## 6. Eigentumsvorbehalt

Die gelieferte Ware bleibt bis zur Erfüllung aller uns aus der gegenseitigen Geschäftsbeziehung zustehenden Ansprüchen unser Eigentum. Der Kunde darf die in unserem Eigentum stehende Ware weder an Dritte verpfänden noch zur Sicherheit übereignen. Bei Pfändung der in unserem Eigentum stehende Ware ist der Kunde verpflichtet, uns sofort zu benachrichtigen und zwar unter Vorlegung der Pfändungspapiere und einer eidesstattlichen Versicherung, aus der hervorgeht, dass die Ware unser Eigentum ist. Die Kosten für eine evtl. notwendig werdende Intervention trägt der Kunde. Der Kunde ist berechtigt, die gelieferte Ware im ordnungsgemäßen Geschäftsgang weiter zu veräußern. Im Falle der Weiterveräußerung tritt an die Stelle der gelieferten Ware der Anspruch des Kunden an seinen Abnehmer, der bis zur Höhe unserer gesamten Forderungen schon jetzt als uns abgetreten gilt. Der Kunde ist zur Einziehung der Forderung bis auf Widerruf berechtigt. Auf Verlangen ist der Kunde verpflichtet, die Abtretung den Drittschuldnern mitzuteilen und uns die zur Geltendmachung unserer Rechte erforderlichen Auskünfte zu geben und Unterlagen auszuhändigen. Die Abtretung der Forderungen wird von selbst inhaftig, sobald der Kunde die Kaufpreisschuld bzw. alle Verbindlichkeiten aus laufender Geschäftsverbindung beglichen hat. Ist der Eigentumsvorbehalt oder die Abtretung nach dem Recht, in dessen Bereich sich die Ware befindet, nicht wirksam, so gilt die dem Eigentumsvorbehalt und der Abtretung in diesem Bereich entsprechende Sicherung als vereinbart. Ist zur Entstehung solcher Rechte die Mitwirkung des Kunden erforderlich, so ist er auf unsere Anforderung hin verpflichtet, alle Maßnahmen zu treffen, die zur Begründung und Erhaltung solcher Rechte erforderlich sind.

## 7. Zahlung

Für die Zahlung sind unsere jeweiligen Bedingungen maßgebend. Abzüge jeder Art ohne die entsprechende Vereinbarung sind unzulässig. Eingereichte Schecks gelten erst nach vollständiger Einlösung als Zahlung. Bei Überschreitung der Zahlungsfrist werden vom Fälligkeitstag an unter Vorbehalt der Geltendmachung weiteren Verzugschadens Verzugszinsen berechnet. Der berechnete Zinssatz beträgt 9 %. Gerät der Kunde mit seiner Zahlung in Verzug, so steht uns das Recht zu, sofortige Zahlung aller offenen, auch noch nicht fälligen Forderungen oder eine Herausgabe der gelieferten Ware bis zur vollständigen Begleichung unserer Forderung zu verlangen.

## 8. Gewährleistung

Beanstandungen über Menge und Qualität können nur angenommen und geprüft werden, wenn sie schriftlich innerhalb von 14 Tagen nach Eingang der Ware am Bestimmungsort vorgenommen werden. Waren, die wir als fehlerhaft anerkennen, nehmen wir zurück und liefern dafür Ersatz. Weiter Ansprüche des Kunden können wir nicht anerkennen.

## 9. Erfüllungsort und Gerichtsstand

Erfüllungsort ist 35279 Neustadt Kreis Marburg, Gerichtsstand - ohne Rücksicht auf die Höhe des Objektes das Landgericht Marburg/Lahn. Maßgebend ist das deutsche Recht.

## 10. Salvatorische Klausel

Sollten Bestimmungen dieses Vertrages unwirksam, unvollständig oder undurchführbar sein, so bleiben die übrigen Bestimmungen unverändert gültig. In diesem Falle soll eine Regelung gefunden werden, die im Rahmen des gesetzlich Zulässigen wirtschaftlich dem am nächsten kommt, was die Parteien gewollt haben oder gewollt haben würden, wenn sie diesen Punkt bedacht hätten.

**Preisliste ist gültig ab 01.03.2019**

# Terms of Sale and Delivery

The following terms of delivery shall be considered as agreed upon at order placement. Deviating agreements shall only obtain validity by our written confirmation. The deviating agreements shall not rescind the remaining terms of sale and delivery.

## 1. Quotation and Conclusion of Contract

Our quotations shall be without engagement. Contracts and other agreements shall only become binding through our written confirmation or our performance. All agreements between us and our customers shall be concluded in writing at conclusion of contract. Agreements made between our employees or representatives and our customers during or subsequent to contract conclusion shall only become valid with our written confirmation; the power of attorney held by our employees or representatives shall be limited in this respect. Supplements, modifications or additional agreements also require the written form. This shall also apply to rescinding the requirement of the written form.

## 2. Delivery Commitment

The customer's unconditional creditworthiness shall be a prerequisite for delivery commitment. Should the terms of payment not be adhered to or circumstances become known which seriously put the customer's creditworthiness into question or if a cheque is not honoured, all receivables become due. On failure of payment within an adequate period of grace set by us, even if devoid of a threat of termination, we shall be entitled to withdraw from the contract in writing and discontinue deliveries and cease all previously performed deliveries. Partial deliveries are admissible. We reserve the right to 10 % over or short delivery for custom-made products, this also applies in case partial deliveries have already been made or are yet to be made. If nothing else has been agreed upon in writing, orders on call must be purchased within three months of expiry of the contractual deadline, without us having to send a reminder containing an explicit purchase deadline. After these three months have expired, we shall optionally be entitled to either invoice the goods or cancel the order. Disruptions and force majeure incidents entitle us to extend the agreed delivery period for the duration of the operative hindrance and a reasonable start-up period. As the case may be our delivery commitments may also be revoked partially or completely. This also applies if it has become impossible for us to deliver at no fault of ours. The customer may then demand our statement as to whether we want to withdraw from delivery or deliver within a reasonable deadline. Compensation claims of any kind resulting from late delivery are limited to 5 % of the order value.

## 3. Delivery Period

The delivery period shall be deemed as adhered to if readiness for shipment has been notified or the object of delivery has left the manufacturing company before expiry of the delivery period. The deadline mentioned in the order confirmation is without engagement unless a separate written delivery confirmation has been issued.

## 4. Prices

Our prices are based on the calculation documents applicable at the time of order acceptance. Deliveries which are performed later than four months after conclusion of contract entitle us to adjust the prices by maximally 5%, e.g. in case of wage increases or increases in material prices.

## 5. Transport

The choice of the route or means of transport is made according to best judgement with no liability for the cheapest route. As far as particular specifications have been provided to us, shipping shall proceed accordingly. The risk of transport shall in any case be borne by the receiver, even if delivery 'free at destination' or FOB a ship has been agreed. On departure from the manufacturing company the goods shall be regarded as delivered according to agreement, even if they are delivered directly to third parties.

## 6. Reservation of Title

We reserve the title for the delivered goods until all our rightful claims resulting from our mutual business relationship have been fulfilled. The customer may neither pledge the goods which are in our property, nor convey them as collateral to third parties. On the seizure of goods which are our property the customer shall be committed to notify us of this immediately and furthermore present us with the seizure documents as well as an affidavit showing that the goods are our property. The expenses for a possibly required intervention shall be borne by the customer. The customer shall be entitled to resell the delivered goods in the regular course of business. In case of a resale, the customer's claim towards the sub-purchaser, which is already considered as assigned to us up to the amount of our total receivables, shall replace the delivered goods. The customer is entitled to collect the receivables until such title is revoked. Upon request the customer is committed to notify the garnishees of such assignment and disclose to us any information and hand out any documents to us required in order to protect our rights. The assignment of the receivables shall lapse as soon as the customer has honoured the debt resulting from the purchase price and/or all debt resulting from the current business relationship. Should reservation of title or assignment be invalid according to the jurisdiction in the area where the goods are located, the collateral which applies in that area ensuring reservation of title and assignment shall be considered agreed. Should the customer's cooperation be necessary for the origination of such rights, customer shall be committed to take all measures required in order to constitute and preserve such rights.

## 7. Payment

Our respective terms are applicable to payment. Deductions of any kind without a respective agreement are prohibited. Cheques that have been handed in shall only be considered as payment after their full encashment. On exceeding the payment deadline default interests shall be charged as of the due date, subject to any claim for further default damages. The charged default interest rate is 9 %. In the event that the customer enters into default with their payment, we have the right to demand immediate payment of all arrears including those which have not yet entered into default, or release of the delivered goods until complete payment of our receivables.

## 8. Warranty

Complaints concerning quantity and quality can only be accepted and examined if made in writing within 14 days after receipt of the goods at the place of destination. Goods which we acknowledge as being defective will be taken back and replaced. Any additional claims by the customer shall not be recognised by us.

## 9. Place of Performance and Jurisdiction, Language

Place of performance shall be 35279 Neustadt Kreis Marburg, Federal Republic of Germany. Place of Jurisdiction - notwithstanding the amount of the subject - shall be the Marburg / Lahn district court. German Law shall prevail. Contract language shall be German. In case of dissent the German version shall prevail.

## 10. Severability Clause

Should any provision of this agreement be or become invalid, ineffective or unenforceable, the validity, effectiveness and enforceability of the remaining provisions shall not be affected thereby. In such event a provision must be found that comes as closest to the legally permitted economic intent and purpose of what the parties had or would have intended had they considered the aspect.

6/09

**This price-list is valid with effect from 01.03.2019**

